

5

Karel Kovarik
**NUMERICAL SIMULATION OF
GROUNDWATER FLOW AND POLLUTION
TRANSPORT USING THE DUAL
RECIPROCITY AND RBF METHOD**

11

Josef Vican - Marian Sykora
**PROBABILISTIC ANALYSIS OF RESISTANCE
DEGRADATION UNDER CORROSION**

17

Daniela Durcanska
**ANALYSIS OF PARTICULATE MATTER
COMPOSITION**

23

Martin Bartovic - Marek Drliciak
**INFLUENCE OF CAPACITY RESTRAINT
FUNCTIONS ON TRAFFIC DISTRIBUTION
AND THEIR PRACTICAL USE IN THE
TRAFFIC MODELLING**

28

Maria Trojanova - Katarina Zgutova
- Lubomir Pepucha - Martin Pitonak
**INTER-LABORATORY COMPARISON
OF ACCREDITED LABORATORIES IN TERMS
OF BENCHMARKING IN SLOVAKIA**

36

Jaroslav Janacek - Michal Kohani
**WAITING TIME OPTIMIZATION WITH
IP-SOLVER**

42

Michal Zabovsky - Matus Chochlik - Karol Matiasko
- Eva Valentikova
**DYNAMIC ARCHITECTURE FOR
ANALYTICAL ITS SERVICES**

46

Miroslav Gabor
**PROPOSAL FOR THE SIZE OF THE FLEET
TO PROVIDE WINTER ROAD MAINTENANCE**

50

Jan Janech - Tomas Baca
**DISTRIBUTED DATABASE SYSTEMS IN
VEHICULAR AD-HOC NETWORK**

55

Juraj Micek - Jan Kapitulik
**TRANSMIT POWER CONTROL ANALYSIS IN
V2X COMMUNICATION SYSTEM**

60

Jaroslav Janacek - Jan Sirc
**THE COLUMN GENERATION TECHNIQUE
FOR PUBLIC TRANSPORT LINE PLANNING
BY IP-SOLVER**

65

Emil Krsak - Hynek Bachraty - Vlastimil Polach
**GTN - INFORMATION SYSTEM
SUPPORTING THE DISPATCHER AND
REMOTE TRACKS CONTROL**

75

Patrik Hrkut
**ARCHITECTURE OF PROVIDING SERVICES
IN INTELLIGENT TRANSPORTATION
SYSTEMS USING SEMANTICALLY DEFINED
INFORMATION**

80

Juraj Micek - Ondrej Karpis
**WIRELESS SENSOR NETWORKS FOR ROAD
TRAFFIC MONITORING**

COMMUNICATIONS

86

Stefan Badura – Anton Lieskovsky
**INTELLIGENT TRAFFIC SYSTEM:
COOPERATION OF MANET AND IMAGE
PROCESSING**

93

Jan Rofar – Maria Franekova – Peter Holecko
**MODELLING OF SAFETY CHARACTERISTICS
OF REDUNDANT SAFETY – RELATED
TRANSMISSION SYSTEM VIA MARKOV'S
ANALYSIS**

98

Eric Mendes – Paulo E. M. Carvalho
– Luís M. Ferreira Gomes
**HYDROGEOLOGIC FRAMEWORK OF THE
GARDUNHA MOUNTAIN: NORTHEAST AREA
– CENTRAL PORTUGAL**

104

Libor Izvolt – Jan Kardos
**INTELLIGENT COMPACTION TECHNIQUE AS
A TOOL OF OBJECTIVE AND EFFECTIVE
APPLICATION OF GEOSYNTHETICS**

112

Jozef Hrbcek – Vojtech Simak – Ales Janota
**USING PREDICTIVE CONTROLLER TO
CONTROL A NONLINEAR SYSTEM**

116

Jozef Gnap – Alica Kalasova – Marian Gogola
– Jan Ondrus
**THE CENTRE OF EXCELLENCE FOR
TRANSPORT SERVICE AND CONTROL**

121

Jana Dicova – Jan Ondrus
**TREND OF PUBLIC MASS TRANSPORT
INDICATORS – AS A TOOL OF TRANSPORT
MANAGEMENT AND DEVELOPMENT
OF REGIONS**

Karel Kovarik *

NUMERICAL SIMULATION OF GROUNDWATER FLOW AND POLLUTION TRANSPORT USING THE DUAL RECIPROCITY AND RBF METHOD

Transport of pollution is strongly influenced by groundwater flow. All numerical models of transport equation must be based on the groundwater flow models. The most of them suffer from numerical diffusion and/or oscillations of solution. Both phenomena lower the quality of results of these models. Plenty of authors are working on improving the quality of the numerical simulation. This paper presents the connection between a dual reciprocity method used to model groundwater flow and the meshless radial basis function methods used for a transport model. Both methods are one of the latest tools for modeling these phenomena.

Introduction

At the dawn of the use of numerical models, they were mostly used to study a groundwater flow in porous media. Today, our environment suffers more and more from by-products of man's industrial activities. Groundwater is one of the things that have sustained extensive damage in the past decade. Even ordinary events in our everyday life can cause pollution of soil or surface water. Numerical models have become a great tool that can be used to predict spreading of pollutants and assess different remediation projects.

Before we start to prepare the model of pollutant transport we need to know groundwater velocity field because the velocity is one of the main phenomena which influences the spreading of pollution in porous media. Therefore, we focused also on the proper numerical method for simulating the groundwater flow. The boundary element method (BEM) is one of the most suitable methods for this purpose because it allows computing the velocity in any point inside the domain. Unfortunately BEM is not very suitable to solve time-dependent groundwater flow and, therefore, we decided to use the dual reciprocity method (DRM) which was developed like an enhancement of BEM (see [6], [4]).

In this paper we used DRM for computing the velocity field and then the computed field is used as an input to the transport model. The groundwater velocity caused an advection and also increased the dispersion in porous media (see [1]). The advection can cause severe problems in numerical models of pollution transport. These problems were solved by different methods such as Galerkin characteristic method (see [5]) or random walk method [4]. In the last few years, there has been tremendous attention focused on the development of meshless methods to alleviate

meshing problems associated with finite element and finite volume methods. The radial basis function method (RBF) was used for simulation of pollutant transport and this method seems to be quite successful.

1. Basic equations

The planar unsteady groundwater flow with a confined surface is governed by the following differential equation

$$T_x \frac{\partial^2 \Phi}{\partial x^2} + T_y \frac{\partial^2 \Phi}{\partial y^2} + \sum_m Q_m \delta(x - x_m, y - y_m) = S \frac{\partial \Phi}{\partial t} \quad (1)$$

where Φ is the potential of groundwater flow (piezometric head) [m], T_x , T_y are the transmissivity coefficients [m^2s^{-1}], S is the storativity coefficient [m^{-1}], Q_m are specific discharges of sources or sinks [s^{-1}], and δ is the Dirac function (see e.g. [1]).

The boundary conditions of equation (1) are divided into three basic groups

- boundary conditions of the 1st kind (the Dirichlet conditions), where the potential's value on the part of boundary Γ_1 is given, i.e. $\Phi = \Phi_0$,
- boundary conditions of the 2nd kind (the Neumann conditions), where the value of the potential's normal derivative (or flux) on the boundary Γ_2 is given, i.e.

$$-\left(T_x \frac{\partial \Phi}{\partial x} n_x + T_y \frac{\partial \Phi}{\partial y} n_y\right) = q_0 \quad (2)$$

where n_x , n_y are the components of a outer normal vector which is perpendicular to the boundary,

* Karel Kovarik

Department of Geotechnics, Faculty of Civil Engineering, University of Zilina, Slovakia, E-mail: karel.kovarik@fstav.uniza.sk

- boundary conditions of the 3rd kind (the Cauchy conditions), where the given potential's normal derivative (flux) is a function of the potential, i.e.

$$-\left(T_x \frac{\partial \Phi}{\partial x} n_x + T_y \frac{\partial \Phi}{\partial y} n_y\right) = f(\Phi) \quad (3)$$

The initial condition is created by the prescribed value of potential at time $t_0 = 0$.

The transport of pollution in porous media is an irreversible, non-stationary process that creates a transition zone where the concentration of pollutant continuously changes from the minimal to the maximal value. This phenomenon is called dispersion and it is a macroscopic reflection of a real movement of particles in pores and a reflection of different physical and chemical phenomena.

The simplest governing equation of transport in porous media is

$$\frac{\partial}{\partial x_i} \left(D_{ij} \frac{\partial C}{\partial x_j} \right) - \frac{\partial}{\partial x_i} (v_{pi} C) = \frac{\partial C}{\partial t} \quad (4)$$

where C is concentration of pollutant, D_{ij} is the tensor of dispersion coefficients and v_p is the porous velocity of groundwater flow.

Eq. (4) is the basic differential equation of a conservative transport of pollutants in a porous medium that is a transport where the pollutant does not react with the environment and it does not spontaneously decay.

The boundary conditions can be again divided into three groups (see [2])

- Dirichlet boundary condition when the known value of concentration is prescribed on the part of boundary Γ_1 , i.e. $C = C_0$,
- Neumann boundary condition (impervious boundary) when the flux of pollutant is zero across the boundary Γ_2 , i.e.

$$D_{ij} \frac{\partial C}{\partial x_j} n_j = 0 \quad (5)$$

- Cauchy boundary condition when the known flux of pollutant is prescribed on the boundary Γ_3 , i.e.

$$\frac{\partial}{\partial x_i} (v_{pi} C) - D_{ij} \frac{\partial C}{\partial x_j} n_j = f(x_i, t) \quad (6)$$

We present the connection of two different methods of solution in this paper. Equation (1) of groundwater flow is solved by a dual reciprocity method; the transport of pollution (Eq. 4) is solved by the local RBF collocation method.

2. Dual Reciprocity Method

The boundary element method (BEM) is very suitable for solving the groundwater flow equation because it can solve exactly the influence of sources and sinks (see [4]). The dual reciprocity method (DRM) developed from BEM in order to remove major disadvantages connected with the non-zero right side of Eq. (1) (see [6]). Equation (1) should be transformed by the following transformation of coordinates

$$\tilde{x} = x \quad \tilde{y} = y \sqrt{\frac{T_x}{T_y}} \quad (7)$$

to the Poisson's equation

$$\frac{\partial^2 \Phi}{\partial \tilde{x}^2} + \frac{\partial^2 \Phi}{\partial \tilde{y}^2} + \frac{1}{T_x} \sum_m Q_m \delta(x - x_m, y - y_m) = \frac{S}{T_x} \frac{\partial \Phi}{\partial t} \quad (8)$$

To solve this equation we use the weighted residuals method (see [8]).

The solution of Eq. (8) can be expressed as the sum of the solution of a homogenous equation and a particular solution $\hat{\Phi}$. The solution of the homogeneous part of this equation can be expressed using the BEM as

$$c_k \Phi_k + \int_{\Gamma_2} \Phi \frac{\partial w_k}{\partial \nu} d\Gamma_2 + \int_{\Gamma_1} \Phi_0 \frac{\partial w_k}{\partial \nu} d\Gamma_1 - \int_{\Gamma_1} q w_k d\Gamma_1 - \int_{\Gamma_2} q_0 w_k d\Gamma_2 + \frac{1}{T_x} \sum_m Q_m w_m = 0 \quad (9)$$

where w_k are the weighting functions defined for a planar problem as

$$w_{ik} = \frac{1}{2\pi} \ln\left(\frac{1}{r_{ik}}\right) \quad (10)$$

We can now divide the boundary Γ to the set of elements like in the BEM and try to find the approximate solution of potential and flux as

$$\Phi(x, y) = \sum_{i=1}^n \Phi_i N_i(x, y) \quad q(x, y) = \sum_{i=1}^n q_i N_i(x, y), \quad (11)$$

where N_i is a set of base functions. We use the simplest form of the base function which is constant in the whole element, i. e. $N_i = 1$ in this paper because these functions are very suitable for solving non-homogeneous areas. Then Eq. (9) can be written as

$$c_k \Phi_k + \sum_{i=1}^N \Phi_i \frac{\partial w_k}{\partial \nu} - \sum_{i=1}^N q_i w_k + \frac{1}{T_x} \sum_m Q_m w_m = 0 \quad (12)$$

In matrix notation we can write

$$Hu - Gq + Q = 0 \quad (13)$$

As finding the particular solution of Eq. (8) is quite difficult, the DRM replaces the solution $\hat{\Phi}$ by a sequence of particular solutions $\hat{\Phi}_i$. The right side of Eq. (8) can be approximated by

$$\frac{\partial \Phi}{\partial t} = \sum_{i=1}^{N+L} \alpha_i f_i, \quad (14)$$

where N is the number of boundary nodes and L is the number of inner points, α_i is a set of unknown coefficients and f_i are approximation functions. The particular solutions from the sequence must fulfil these equations

$$\Delta \hat{\Phi}_i = \frac{S}{T_x} f_i. \quad (15)$$

The approximation functions f_i can be chosen as

$$f_i = 1 + r_i + r_i^2 + r_i^3 + \dots + r_i^m. \quad (16)$$

The sequence of particular solutions $\hat{\Phi}_i$ has the form of a series

$$\hat{\Phi}_i = \sum_{k=0}^m \frac{r_i^{k+2}}{(k+2)^2}, \quad (17)$$

and the exterior normal derivative is

$$\frac{\partial \hat{\Phi}}{\partial \nu} = \frac{\partial r_i}{\partial \nu} \sum_{k=0}^m \frac{r_i^k}{k+2}. \quad (18)$$

If we substitute relations (17) and (18) to Eq. (15), we obtain the governing equation

$$\Delta \Phi = \sum_{i=1}^{N+L} \alpha_i (\Delta \hat{\Phi}_i). \quad (19)$$

Then we apply approaches similar to BEM and afterwards we acquire

$$\begin{aligned} c_i \Phi_k + \sum_{i=1}^N \Phi_i \frac{\partial w_{ik}}{\partial \nu} - \sum_{i=1}^N q_i w_{ik} + \sum_m Q_m w_{km} = \\ = \sum_{j=1}^{N+L} \alpha_j \left(c_k \hat{\Phi}_{kj} + \sum_{i=1}^N \hat{\Phi}_i \frac{\partial w_{ik}}{\partial \nu} - \sum_{i=1}^N \frac{\partial \hat{\Phi}_i}{\partial \nu} w_{ik} \right) \end{aligned} \quad (20)$$

The unknown coefficients α_i in Eq. (20) can be determined from Eq. (14) as

$$\alpha_i = \sum_{j=1}^{N+L} F_{ij}^{-1} \frac{\partial \Phi_j}{\partial t}, \quad (21)$$

where we denoted F^{-1} the inverse matrix to the matrix of approximation functions f_{ij} . A matrix form of Eq. (20) is

$$Hu - Gq + Q = (H\hat{u} - G\hat{q})F^{-1}\hat{u}. \quad (22)$$

where u is a vector of unknown potentials and q is a vector of unknown fluxes through elements.

The left side of Eq. (22) is totally identical with the solution of homogenous Eq. (13). On the right side, there are matrices H and G along with the matrices of particular solutions. The matrices of particular solutions can be easily set up using relations (17) and (18). These matrices are full and non-symmetrical. The vector \hat{u} consists of time derivatives of potential and flux values and any standard time-integration scheme can be used to find a solution of system defined by Eq. (22). The variables u and q can be interpolated in time as (see [6])

$$u = (1 - \theta_u)u^n + \theta_u u^{n+1} \quad q = (1 - \theta_q)q^n + \theta_q q^{n+1} \quad (23)$$

where u^n, q^n and u^{n+1}, q^{n+1} are the values of variable u, q at time intervals n and $n+1$, respectively. The values θ_u and θ_q are parameters which position the value of u and q , respectively between the time intervals n and $n+1$. If we choose $\theta_u = \theta_q = 0.5$ we get the well-known Crank-Nicholson scheme.

The DR method requires a certain number of points to be given inside the domain of solution. The inclusion of boundary conditions is the same as in the BEM because the DR method is a variant of BEM.

3. Local RBF Method

Radial basis functions (RBF) are initially known as a powerful tool for approximating multivariate functions on a scattered data. Due to their mesh-free nature RBF have received an increasing attention for solving partial differential equations (PDE) of different kinds. The first trial of such exploration was made by Kansa [3].

Full exploitation of the RBF method was constrained by the progressive ill-conditioned coefficient matrix as the number of nodes increases. To remove this difficulty, Shu at al. (see [7]) suggested using the local RBF method in which the approximation is formed by using only several local supporting points.

The unknown concentration function $C(x)$ is approximated in a sub-domain Ω_i which forms the neighbourhood or support of a reference point x_i by weighted sum of multiquadric functions and polynomials

$$C(x) = \sum_{j=1}^N \lambda_j \varphi(r_j) + \sum_{j=1}^m \gamma_j p_j(x), \quad (24)$$

where λ_j and γ_j are weights, $\varphi(r_j)$ are the RBF basis functions, and p_j is a basis for polynomial space with degree $m-1$, m is the order of φ .

Multiquadric functions are one of the most popular radial functions used for this purpose and they are defined as

$$\varphi(r_j) = \sqrt{r_j^2 + \epsilon^2} \quad (25)$$

where r_j is a distance from a point and ϵ is a so-called shape factor of multiquadric function. The order m of multiquadric functions is equal to one and, therefore, we need one additional condition to make the interpolation problem well-posed. This condition is

$$\sum_{j=1}^N \lambda_j = 0 \quad (26)$$

The interpolation problem can be written in a matrix form as

$$A = \begin{bmatrix} \varphi & p \\ p^T & \mathbf{0} \end{bmatrix} \begin{bmatrix} \lambda \\ \mathbf{0} \end{bmatrix} = \begin{bmatrix} C \\ \mathbf{0} \end{bmatrix} \quad (27)$$

The differential quadrature (DQ) method was used to approximate derivatives. The derivative at a point x_i can be approximated by DQ as

$$\left. \frac{\partial C}{\partial x} \right|_{x=x_j} = \sum_{j=1}^{N_i} w_{ij} C(x_j) \quad (28)$$

Now we apply Eq. (28) to the basis functions in Eq. (24) and we get

$$\frac{\partial \varphi(r_i)}{\partial x} = \sum_{j=1}^N w_{ij} \varphi(r_j) \quad (29)$$

and we can compute the weighting coefficient as

$$w = A^{-1} \frac{\partial \varphi}{\partial x} \quad (30)$$

The same principle can then be used for derivatives of higher order.

The transport equation (4) can be solved in time using the similar time approximation like in Eq. (23)

$$C = (1 - \theta)C^n + \theta C^{n+1} \tag{31}$$

We can now write Eq. (4) as

$$\theta \Delta t \mathcal{L}_1(C^{n+1}) = (\theta - 1) \Delta t \mathcal{L}_2(C^n), \tag{32}$$

where we used two operators

$$\begin{aligned} \mathcal{L}_1 &= \frac{\partial}{\partial x_i} \left(D_{ij} \frac{\partial}{\partial x_j} \right) - v_{pi} \frac{\partial}{\partial x_i} - \frac{1}{\theta \Delta t}, \\ \mathcal{L}_2 &= \frac{\partial}{\partial x_i} \left(D_{ij} \frac{\partial}{\partial x_j} \right) - v_{pi} \frac{\partial}{\partial x_i} - \frac{1}{(\theta - 1) \Delta t} \end{aligned} \tag{33}$$

The solution of PDE is based on a collocation method, i. e., we try to find the solution in the set of nodes placed inside the domain Ω and on boundary Γ . The domain is discretized by $N = N_I + N_B$ nodes (N_I is the number of interior and N_B is the number of boundary nodes). For each node $x_i, i = 1 \dots N$ we assume the N_I nodes are used in the support domain to interpolate the unknown variable C . Now we can obtain the weights w_1 and w_2 for operators \mathcal{L}_1 and \mathcal{L}_2 as

$$w_1 = A^{-1} \mathcal{L}_1(\varphi) \quad w_2 = A^{-1} \mathcal{L}_2(\varphi) \tag{34}$$

Using these weights we can form the global system of linear equations and solve it. The solution is the value of concentrations in all the nodes at the time interval t_{n+1} .

4. Numerical examples

For the validation of the proposed numerical approach, several standard test problems are considered.

Pumped well in circular aquifer

First of all we validate the groundwater flow model. It is tested on the interesting example of a pumped well in a homogeneous

aquifer. This example can be solved analytically only for an infinite aquifer. The drawdown can be computed as

$$s = \frac{Q}{4\pi T} \int_u^\infty \exp(-x) dx \tag{35}$$

where T is the transmissivity coefficient, Q is the pumped discharge and u is defined as

$$u = \frac{r^2 S}{4Tt} \tag{36}$$

Here r is the distance from the pumped well, S is coefficient of storativity, and t is time.

The numerical model can not model the infinite domain. We prepared a circular domain with a diameter of 20 m and the Dirichlet boundary condition around. The boundary was divided into 20 elements and 32 internal points (see Fig. 1). Time step was $\Delta t = 0.005$ [day]. We compared only very short time intervals to eliminate the influence of these boundary conditions. Results are pre-

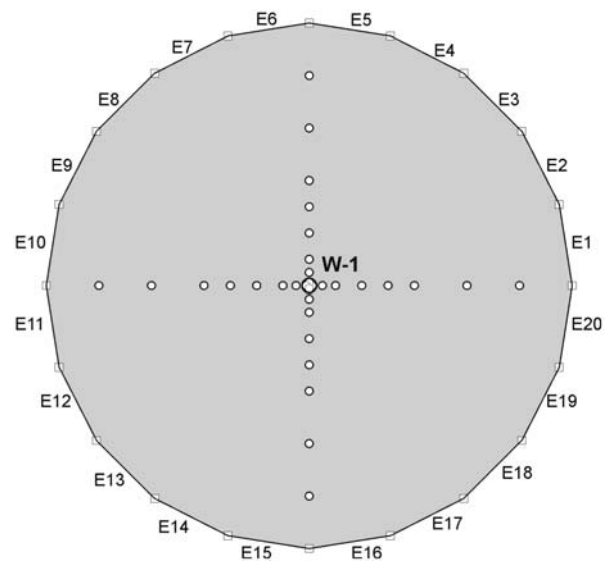

Fig. 1 Network for test of pumped well

Comparison of results for pumped well solution

Table 1

Distance [m]	Drawdown [m] Analytical		Drawdown [m] DRM		Difference [m]	
	Time t = 0.1 [day]	Time t = 0.2 [day]	Time t = 0.1 [day]	Time t = 0.2 [day]	Time t = 0.1 [day]	Time t = 0.2 [day]
0.1	0.65762	0.71278	0.6502	0.7087	0.00742	0.00408
0.5	0.40175	0.45676	0.3943	0.4526	0.00745	0.00416
1	0.29229	0.34688	0.2850	0.3427	0.00729	0.00418
2	0.18537	0.23827	0.1785	0.2337	0.00687	0.00457
3	0.12633	0.17655	0.1201	0.1712	0.00623	0.00535
4	0.08792	0.13462	0.0824	0.1282	0.00552	0.00642
6	0.04260	0.08058	0.0382	0.0705	0.00440	0.01008
8	0.01980	0.04833	0.0149	0.0315	0.00490	0.01683
10	0.00862	0.02846	0	0	0.00862	0.02846

sented in Table 1. These results are quite satisfactory and we can see that the DRM method gives very good values also in the vicinity of the pumped well on the contrary to other numerical methods (e. g. finite elements).

Convective-diffusion transport equation

In this section, the solution of the convection-diffusion equation with a constant diffusion coefficient and convection velocity is presented. Only a longitudinal diffusion and convection are considered. The governing equation is

$$D \frac{\partial C}{\partial x} - v \frac{\partial C}{\partial x} = \frac{\partial C}{\partial t} \tag{37}$$

The analytical solution of the above transport problem in a one-dimensional semi-infinity domain with initial and boundary conditions

$$C(x,0) = 0 \quad C(0,t) = C_0 \tag{38}$$

is given by the following expression (see Bear (1972))

$$C = \frac{C_0}{2} \left[\operatorname{erfc} \left(\frac{x - vt}{2\sqrt{Dt}} \right) + \exp \left(\frac{vx}{D} \right) \operatorname{erfc} \left(\frac{x + vt}{2\sqrt{Dt}} \right) \right] \tag{39}$$

where *erfc* is an error function.

We prepared a numerical model using a local RBF method. The semi-infinity domain was treated in a numerical model as a rectangular one of 10x4 m. The network had 84 boundary points and 585 internal points. We can compare only short time intervals because of the influence of the rectangular domain boundary at $x = 10$. The boundary condition $C(0,t) = 100$, the coefficient of diffusion is 0.1 and velocity $v = 1$.

Comparison of results of numerical and analytical solution for time $t = 2$ and $t = 4$ is presented at Fig. 2.

The influence of the shape factor ϵ (Eq.25) was also studied and values of relative errors for different values of the shape factors are presented in Fig. 3. The finding of the optimal value is a very interesting and complicated problem and has not been satisfactorily solved yet.

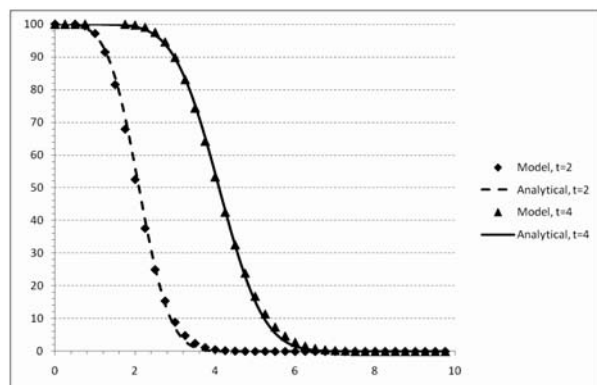

Fig. 2 Comparison of results, shape factor $\epsilon = 1.0$

5. Conclusions

Numerical models became a great tool that can be used to predict spreading of pollutants and assess different remediation projects. There exist plenty of commercial software systems to solve the transport equation but the new numerical methods seems to be more effective for simulation this phenomena. The paper try to present two non-usual methods for solution of coupled problem of groundwater flow and pollution transport in porous media.

The dual reciprocity method and truly meshless local RBF method is used for contaminant transport modelling. The presented numerical results show the simplicity and quite good accuracy of both methods.

The advantage of the dual reciprocity method is the introduction of point sources (wells) into the domain. The sources can be placed arbitrarily inside the domain without having the change the network of elements. The computed values of potential in the point source and its neighbourhood are very precise.

The truly meshless method using the local RBF interpolation connected with collocation solution of the governing dispersion equation is used to solve the transport equation. Numerical results show a good accuracy of this method. The study of influence of the shape factor will continue to improve the usability of the local RBF method in modelling of contaminant transport.

Acknowledgment

This work was supported by the European Fund of Regional Development under contract No 26220120027 Centre of Excellence in Transport Engineering.

This contribution is the result of the project implementation:

Acknowledgment

This work was supported by European Fund of Regional Development under the contract No 26220120027 Centre of Excellence in Transport Engineering.

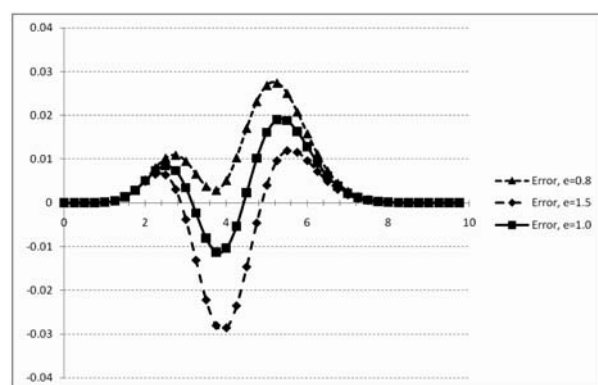

Fig. 3 Relative errors for different shape factors

References

- [1] BEAR, J.: *Dynamics of Fluids in Porous Media*. American Elsevier : New York, 1972
- [2] BEAR, J., VERRUIJT, A.: *Modelling Groundwater Flow and Pollution*, D. Reidel : Dordrecht, 1987
- [3] KANSA, E.J.: *Multiquadrics - A Scattered Data Approximation Scheme with Application to Computational Fluid Dynamics*, Comput. Math. Appl., Vol.19, 1990, pp. 127-145
- [4] KOVARIK, K.: *Numerical Models in Groundwater Pollution*, Springer: New York, 2000
- [5] MAHMOOD, M. S.: *Solution of Strongly Nonlinear Convection-diffusion Problems by a Conservative Galerkin Characteristics Method*, Numerische Mathematik, Vol. 112, 2009, pp. 601-636.
- [6] PARTIDGE, P.W., BREBBIA, C.A., WROBEL, L.C.: *The Dual Reciprocity Boundary Element Method*, Elsevier : London, 1992
- [7] SHU, C., DING, H., YEO, K.S.: *Local Radial Basis Function-based Differential Quadrature Method and its Application to Solve Two-dimensional Incompressible Navier-Stokes Equations*, Comput. Meth. Appl. Mech. Eng., Vol. 192, 2003, pp. 941-954
- [8] TELLES, J.C.F., BREBBIA, C.A.: *The Boundary Element Method in Plasticity*, Brebbia CA(ed) New developments in boundary element methods, pp. 295-317 CML Publications, Southampton, 1980.

Josef Vican – Marian Sykora *

PROBABILISTIC ANALYSIS OF RESISTANCE DEGRADATION UNDER CORROSION

To observe the behaviour and resistance of steel bridges with the orthotropic plate decks, the nonlinear finite probabilistic model in the ANSYS software environment was developed using software support module PDS. Random variables were described by means of parameters of probability density function according to data determined experimentally. The model takes also into account the geometrical and material nonlinearities of the structure. The major aim of the paper is to obtain the corrosion effects influence on the resistance of this structural system. Therefore the time variant loss of member resistance was computed based on selected corrosion models.

Keywords: prediction of ultimate strength, time – dependent corrosion effects, stochastic modelling using FEM software.

1. Introduction

Stiffened plated structural elements are the main and very important parts of the box girder bridge structures or the bridge structures with ballast bed. Their structural integrity has direct implications on the safety and reliability. Accurate prediction of the ultimate strength of stiffened plated elements is a very important task for engineers. There has been conducted extensive work in predicting the compressive strength of rectangular plated elements since 1970s. However, much less work has been devoted to the probabilistic formulation of their ultimate strength. An adequate probabilistic model of the ultimate strength is necessary to develop for structural reliability assessment of those types of structures due to significant uncertainties of the initial performance, effects of deterioration and because of the stochastic nature of all factors affecting the resistance (structural geometric characteristics, material properties).

The effort was focused on the determination of stress state of compression orthotropic decks creating the upper flanges of bridges with ballast beds. Their stress state is significantly influenced by the interaction of buckling, shear lag and effect of transverse load due to traffic action resulting from the deck performance. Concurrently, the geometrical and material nonlinearities should be taken into account. To analyze the behaviour and resistance of the bridge orthotropic deck subjected to traffic action, the nonlinear computational model of the railway bridge with the ballast bed was developed using software ANSYS.

Nevertheless, the actual structural member resistance could be changed by various factors like degradation of materials due to aggressive environment. In general, deteriorating structures are maintained in accordance with their condition states. Because of

limited available resources, incorrect maintenance decisions and although many quality corrosion protection systems are available at present, phenomena of corrosion as the basic and most important degradation effect is significant all the time.

Effects of this degradation cause material loss leading to the reduction of structural resistance. Corrosion effects influencing member resistance can be obtained by means of a structural model based on some corrosion models. Then, corrosion effects could be expressed in the form of the time variant loss of the resistance. The parametric study of simulation of corrosion effect was realized to observe the variation of the bridge ultimate strength within the bridge service lifetime resulting from the generalized corrosion of the bridge stiffened deck plate.

2. Structural model

Two numerical finite calculation models were developed – the deterministic model and the probabilistic one. To determine the resistance of compression stiffened flange, the orthotropic plate was necessary to model using thin shell elements with the adequate finite element mesh allowing for the effect of plasticization and large deflections. The developed model was calibrated using the results of experimental analysis with emphasis on the real structural behaviour.

A bridge structure was modeled using shell finite elements of SHELL 181. Von Mises isotropic nonlinear plastic material model with bilinear hardening was applied to describe material characteristics given by the bilinear stress – strain diagram with the elasticity module $E = 210$ GPa, hardening module of $E/100$ and yield strength of $f_y = 285.91$ MPa corresponding to the measured and

* Josef Vican, Marian Sykora

Department of Structures and Bridges, Faculty of Civil Engineering, University of Zilina, Slovakia, E-mail: vican@fstav.uniza.sk

evaluated actual mean value of the yield strength of the real bridge structure.

Due to absence of measured initial imperfections, the standard equivalent geometrical initial imperfection in the form of sinusoidal surface was incorporated into the calculation model. The transverse displacement fields of imperfect plates are normally represented by a double Fourier series. For generally used ratios of plate dimensions, following equation was considered for modeling the initial imperfections

$$w_0 = f_0 \sin \pi x / a \sin \pi y / b, \tag{1}$$

where f_0 is the value of initial plate bow amplitude, a and b are the plate length and width respectively.

The amplitude of the longitudinal stiffener initial bow was considered by the value of $a/400$ in accordance with EN 1993-1-5 and the initial bow of the deck sheet in transversal direction between longitudinal stiffeners was given in the form of “hungry horse” with the amplitude $b/200$.

The resulting shape of the global bridge deck imperfection shape can be seen in Fig. 1.



Fig. 1 Deterministic finite element model of orthotropic plate deck - shape of initial deformation (multiplied 100 times) with finite element mesh.

The probabilistic model was developed using deterministic one and software support module PDS (Probabilistic Design System) allowing for direct connection between FEM analysis and methods of the probability analysis. Based on the parameters of material characteristics as well as other random variable input values and their statistical models, PDS module enables to generate files of random variables and to calculate required probabilities. Using sensitivity analysis, the effect of input parameters on the structural resistance could be determined achieving the reliability optimal level.

Random character of individual values was considered in accordance with the Gaussian random process. Random variables were described by means of parameters of probability density distribution according to data determined experimentally. The calculation was carried out using LHS simulation method for 40 steps of the data dispersion. The nonlinear calculation ran in every step determining random output parameters in the form of stresses and deformations of girder bottom flanges in experimentally measured places (see Fig. 2). Concurrently, in frame of probabilistic calculation, the effect of random input variables on the stress and deformation intensity was evaluated by means of stochastic sensitivity analysis using Spearman correlation coefficients. All variables were taken into account as parameters influencing sensitivity and the resulting effect was introduced using the percent expression.

3. Corrosion modelling

Corrosion of the plate deck due to environmental conditions was taken into account. Two cases of the bridge deck corrosion were considered. Firstly, the corrosion was supposed to be acting on the lower part of bridge deck only under the assumption that the deck insulation would be serving during the whole bridge lifetime. Secondly, the corrosion was considered to act on the lower and also upper part of the bridge deck, so that the bridge insulation was not perfect during the whole bridge lifetime. Due to absence of the actual corrosion model of this structural model, known corrosion prediction models were used for corrosion modeling of the lower part of the bridge deck. Therefore, general models of Akgul-Frangopol [1] and of Qin - Cui [3] were used.

Input random variable specifications

Table 1

No.		Name of parameterType of distribution	Type of distribution	Mean value	Cov.
1	<i>TPL</i>	Thickness of plate	Normal	14.076	0.15500
2	<i>TFHN</i>	Thickness of main girder flange	Normal	50.070	0.21800
3	<i>TFPR</i>	Thickness of cross beam flange	Normal	15.561	0.14300
4	<i>TVYST</i>	Thickness of stiffener	Normal	25.310	0.28400
5	<i>TWHN</i>	Thickness of main girder web	Normal	14.272	0.17600
6	<i>VYSKAVYST</i>	Stiffener height	Normal	248.89	1.80500
7	<i>EXI</i>	Elasticity modulus	Log - normal	210000	8400.0
8	<i>FYI</i>	Yield strength	Log - normal	285.91	16.09000

The corrosion losses were determined using following relations expressing the mean value and standard deviation in the case of Frangopol model

$$\mu_{d_{corr}} = 0.03207t^{0.5}, \tag{2}$$

$$\sigma_{d_{corr}} = 0.00289t^{0.045}, \tag{3}$$

and in the case of Qin-Cui model

$$\mu_{d_{corr}} = 1.67[1 - \exp(-t/9.15)^{1.97}], \tag{4}$$

$$\sigma_{d_{corr}} = 0.0674[1 - \exp(-t/0.181)^{0.0294}], \tag{5}$$

where t is time in years.

Corrosion effect was taken into account by means of thickness reduction d_{corr} calculated according to the above mentioned probability models using following relation

$$t_{pl,red} = t_{pl} - d_{corr} \tag{6}$$

where t_{pl} is the plate thickness without corrosion effects.

4. Numerical analysis of corrosion influence on the resistance

Numerical analysis was accomplished using the calculation model described in chapter 2. The calculation model developed in the software environment ANSYS consisted of 56472 nodes, 45163

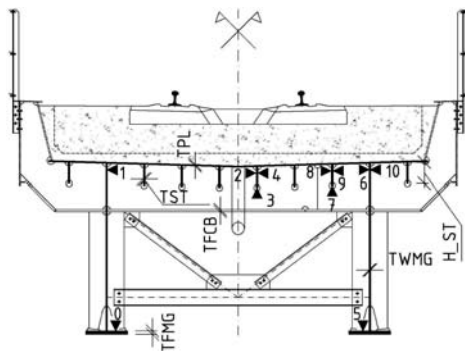

Fig. 2 Cross section of bridge with ballast bed

shell elements and 44 beam elements. The traffic action was modeled as the uniformly distributed load, due to load distribution through the ballast bed under railway sleepers in the slope of 4:1 according to the EN 1991-2.

Firstly, the deterministic geometric and material nonlinear analysis of the imperfect structure (GMNIA) using average cross-sectional characteristics was accomplished. Then using incremental analysis, the resistance of bridge structure was determined under assumption that the limit state of the structure was declared by the structural collapse represented by the maximum load attainment in numerical calculations. Also the stresses were controlled to observe the state when the bridge deck would be in an elastic-plastic state and the plastic strain could achieve the value of $2\epsilon_y$ (ϵ_y corresponds to the steel yield strength).

Secondly, the stochastic analysis was realized. The results of this analysis (the mean values and standard deviations) are shown in Table 2 compared to the deterministic one. Some outputs of this analysis can be seen in Figs. 5-7.

In this study, the effect of random input variables on the stress and deformation intensity was evaluated by means of stochastic sensitivity analysis using Spearman correlation coefficients. All variables were taken into account as parameters influencing sensitivity and the resulting effect is introduced in percent expression. Because of the limited paper size, there are presented only the results of stresses at the midspan of longitudinal stiffener. Nevertheless, it can be seen from the Figures that the importance level of the stiffener cross-sectional characteristics is higher in the case of elastic range. In the case of collapse, the greatest importance level was achieved by the yield strength. These results were confirmed by the matrix of the rank correlation coefficient.

The time variant analyses were the third and fourth analysis type, by which the time dependent effects of the environmental action in the form of corrosion were taken into account. For both above mentioned prediction models of corrosion losses, the time-dependent development of resistance within the design working life of 100 years was computed. The resistance was computed in discrete time points with time step of 5 years until 25 years and then was used the time step of 25 years. The time-dependent development of the maximum applied load on the structure (at the collapse) can be seen in Fig. 6 and the time-dependent development of minimum and maximum stresses in the middle of the bridge structure span can be seen in Fig. 7 (for the same load intensity

Comparison of obtained stresses (the load intensity 250 kN.m^{-2}).

Table 2

Stress [MPa]	σ_0	σ_1	σ_2	σ_3	σ_5	σ_6	σ_7	σ_8
Results from								
Design calculation EN1993-1-5	350.94	-277.59	-267.47	-105.08	350.94	-277.59	-93.36	-191.83
ANSYS - deterministic	287.32	-258.79	-271.28	-108.53	290.28	-264.54	-79.63	-157.39
ANSYS - stochastic - mean	287.48	-259.31	-272.89	-106.37	290.35	-265.54	-81.82	-158.70
-standard deviation	15.665	8.226	7.265	14.708	15.121	8.713	3.110	6.938

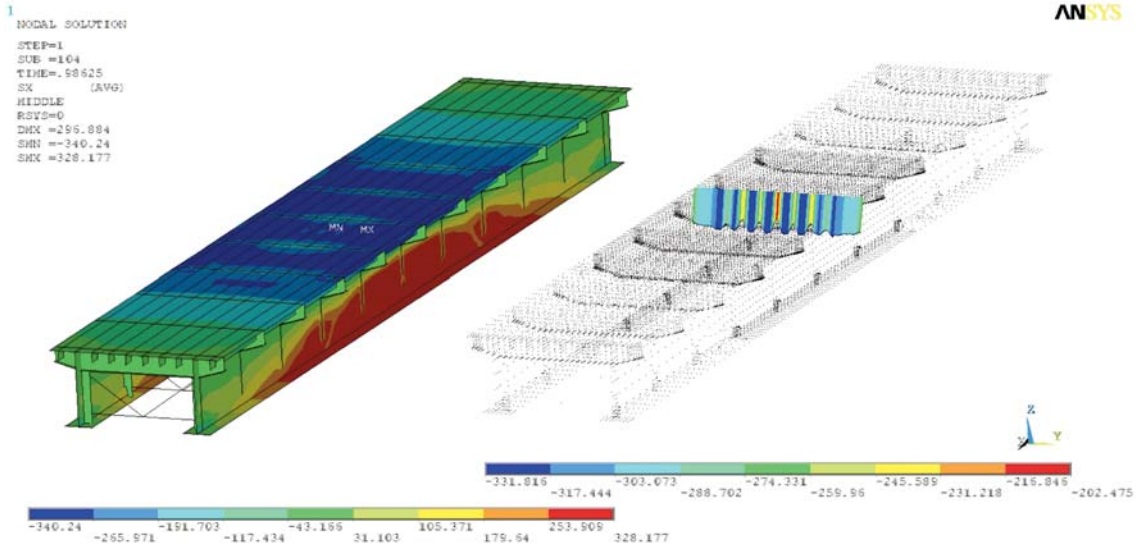

Fig. 3 Obtained stress state plot at collapse

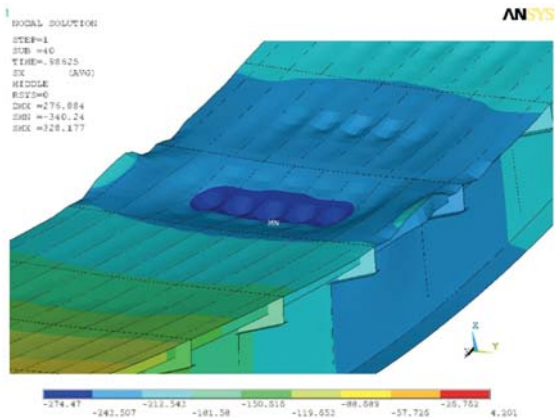

Fig. 4 Deformed deck shape at collapse

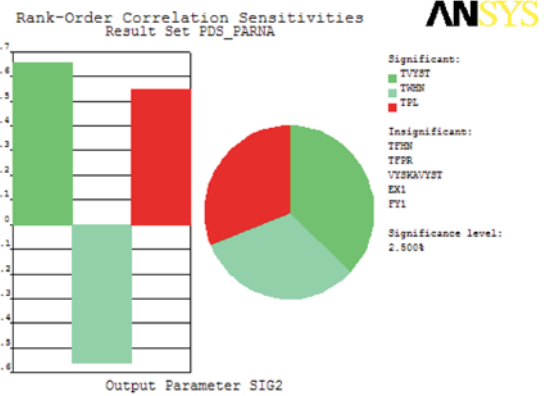

Fig. 5 Sensitivity plot for sigma 2

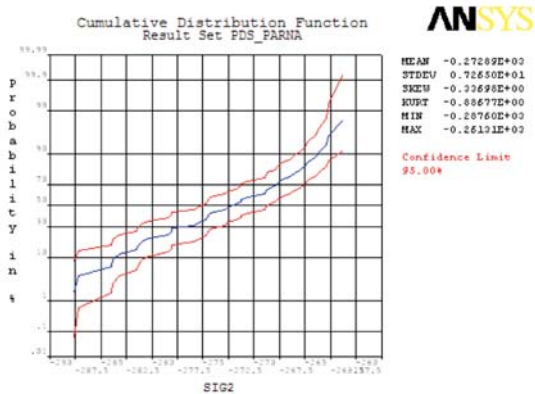

Fig. 6 Cumulative distribution function of the sigma 2

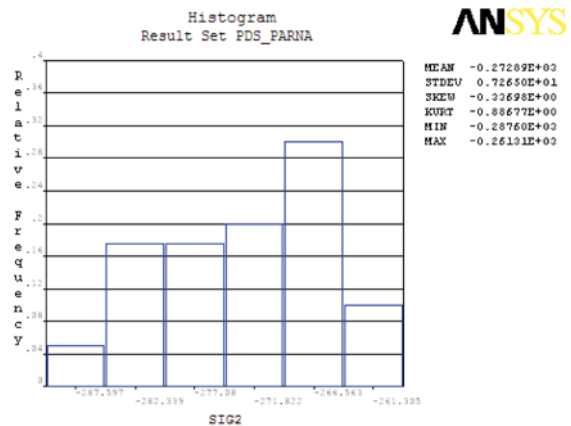

Fig. 7 Histogram of output parameter of the sigma 2

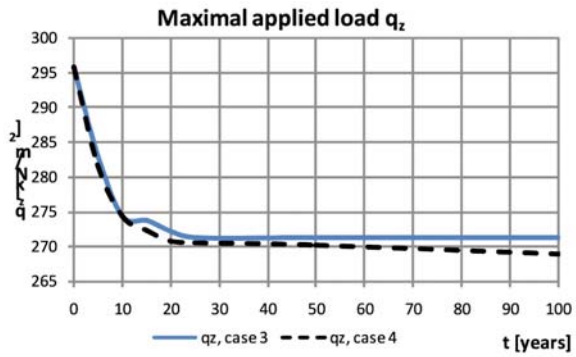

Fig. 6 Time-dependent development of maximal applied load on the structure

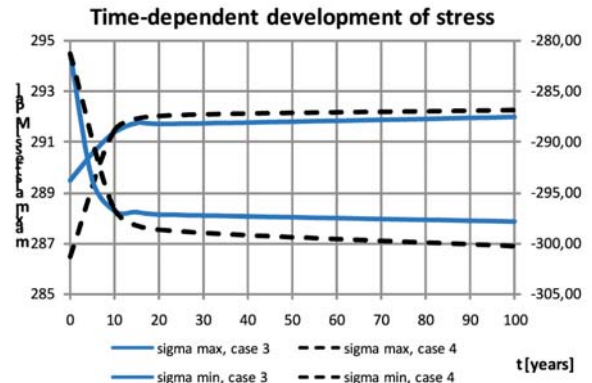

Fig. 7 Time-dependent development of peaks of stresses

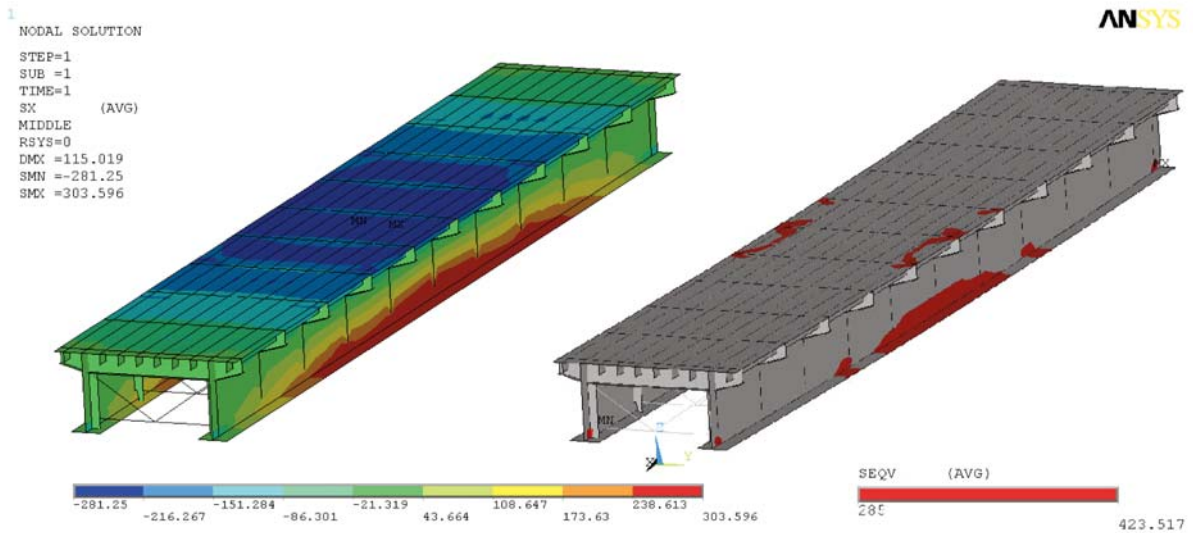

Fig. 8 Obtained stress state plot in the time = 0 years, load intensity = 250 kN/m²

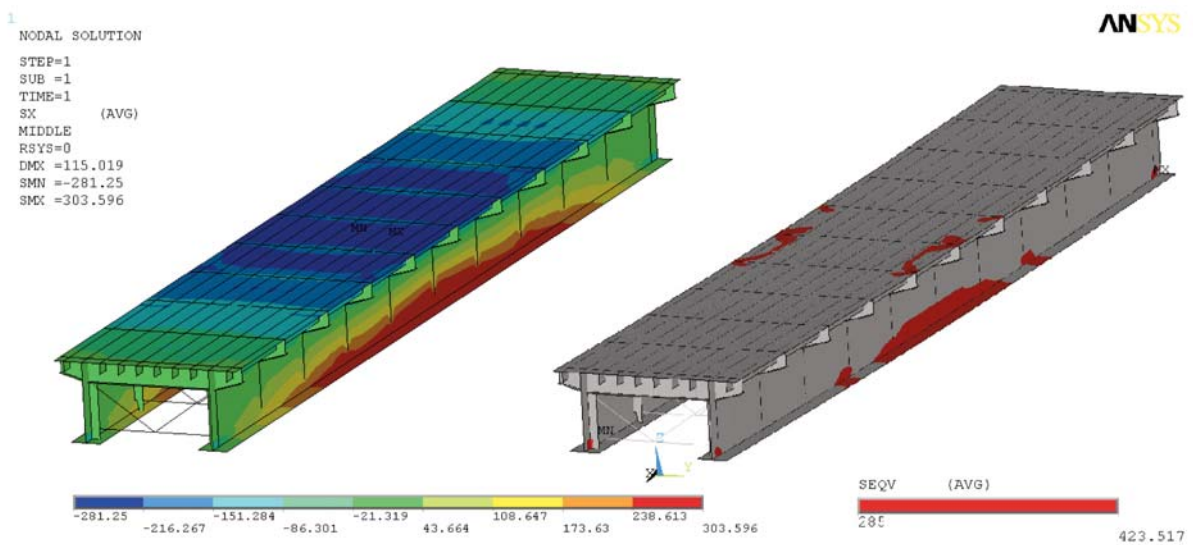

Fig. 9 Obtained stress state plot in the time = 100 years, load intensity = 250 kN/m².

of 250 kN.m^{-2}). From Figs. 6 and 7 it can be seen that there is a little difference between the values of both cases, if the corrosion affect only the bottom side of bridge deck or both sides (also corrosion under ballast bed).

5. Conclusion

The paper presents specifications of the real behaviour of the bridge orthotropic plated deck with the ballast bed. The probability distribution of the ultimate strength of the imperfect bridge deck structure under out-of-plane load and axial compression resulting from global bending was evaluated in dependence on several random variables and assessed by a nonlinear finite element analysis.

The bridge deck resistance is significantly influenced by the corrosion degradation and therefore the corrosion effects should be taken into account for a structural design. On other hand, the bridge deck resistance is ensured by structural redundancy accord-

ing to the Slovak standard at the present time. Although the corrosion effect means the structural resistance decrease by about 11 %, it is controversial to increase the deck plate thickness according to the recommendation in EN 1993-1-1, whereas the difference of the corrosion effect in cases 3 and 4 respectively is not significant.

Another parametric study has to be carried out for various deck plates and longitudinal stiffener slenderness using stochastic analysis to obtain more results for more sophisticated conclusion analysis. Except of that, the research of corrosion processes under the insulation of the bridge deck should be conducted to obtain the actual model of corrosion losses prediction.

Acknowledgement

The paper presents results of the project implementation: "Centre of Excellence in Transport Engineering" (ITMS: 26220120027) supported by the Research & Development Operational Programme funded by the ERDF.

References

- [1] AKGUL, F., FRANGOPOL, D. M.: Lifetime Performance Analysis of Existing Steel Girder Bridge Superstructures. *Journal of Structural Engineering*, v. 130, No. 12, pp. 1875–1888.
- [2] BUCHER, CH., HINTZE, D., ROSS, D.: *Advanced Analysis of Structural Reliability Using Commercial FE-codes*. EC-COMAS, Barcelona, 2000
- [3] QIN S., CUI W.: Effect of Corrosion Models on the Time-dependent Reliability of Steel Plated Elements. *Marine Structures*, Elsevier, 2003.
- [4] SYKORA, M., VICAN, J.: *Numerical and Experimental Analysis of Steel Orthotropic Plate Deck Stress State*. XVIII. Russian-Slovak-Polish seminar Theoretical foundation of civil engineering. Warszawa: Oficyna Wydawnicza Politechniki Warszawskiej, 2009.
- [5] SERTLER, H., VICAN, J.: *The Real Behaviour of Steel Railway Bridges*. Zilina: ES VSIDS, 1995 (in Czech).
- [6] EN 1993-1-5: *Design of Steel Structures - Part 1-5: Plated Structural Elements*. CEN: Brussels, 2003.
- [7] ANSYS Reference manual: Release 10.0 Documentation for ANSYS.

Daniela Durcanska *

ANALYSIS OF PARTICULATE MATTER COMPOSITION

According to current research, particulate matter (PM) has a negative impact on citizens in particular (respiratory and cardiovascular diseases). Based on EU studies, deaths of 347,900 Europeans are attributable to air pollution. Formation of particulate matter from road transport has been a concern for big cities in particular.

For long time monitoring PM we choosed the sections of roads located both within urban areas and rural areas were selected for long-term monitoring, differing in particular by the surface of the roadway – either with asphalt concrete paving (AC) or with stone mastic asphalt (SMA) paving, an asphalt compound with disintegrated stone grade and a higher percentage of asphalt binder.

We were executed the Air Samples with using medium-volume LECKEL MVS6 sampling pump.

Keywords: traffic, emissions, environment, monitoring, PM10

Introduction

Considering the predominant use of combustion engines, exhaust gases contain high amount of both gaseous and solid contaminants. They include high quantities of the finest fractions that can stay in the air for a long time; they can easily enter the respiratory tract and be harmful to human health.

The Faculty of Civil Engineering of the University of Zilina, Department of Highway Engineering has participated in the international project “SPENS Sustainable Pavements for European New Member States” [3] aimed at sustainable transport and focusing on evaluation of effects of different types of roadways on generation of particulates caused by transport. The Department continues this focus also in research activities of the Centre of Excellence for Systems and Services of Intelligent Transport.

The aim of this part of the work to be presented is to compare development of particulate matter and its composition along roads depending on surface type of the road.

1. Particulate Matter Monitoring

Sites representing both non-urban and urban roads with various traffic volumes and various surface types were selected to monitor concentrations of specific fractions of the particulate matter at locations with different traffic volume.

Air samples were taken using medium-volume LECKEL MVS6 sampling pumps. The devices are intended for outdoor use at high or low temperatures. The flow of the air to be taken is controlled and basic physical parameters are maintained by means of a ther-



Fig. 1 Automatic system for traffic intensiveness monitoring (SIERZEGA SR4)

* Daniela Durcanska

Faculty of Civil Engineering, University of Zilina, Slovakia, E-mail: daniela.durcanska@fstav.uniza.sk



Fig. 2 Filter weighing by means of analytical scales (left); measuring position by the D1 highway (right)

mally compensated slot. PM capturing filters are inserted between Teflon holders into a sampling head forming an integral part of the device. Filters from nitrocellulose fibres were used to capture PM (Fig. 2).

Measurements were taken in compliance with the European standards EN 12341 [8] and EN14907 [9] where this methodology is used as a reference method.

- Particle concentrations were determined gravimetrically from every exposed filter. Traffic volume was recorded continuously using an automatic traffic intensiveness detector SIERZEGA SR4. Detector - the microwave radar Works at the base of dopplers principle (Fig. 1).

Multiple measurements were taken at four sites between 2007 and 2009. Most measurements focused on PM10 monitoring. Representation of different particles was monitored at two sites in July and October 2008, taking samples to monitor chemical composition of PM.

The positions were selected as follows (Fig. 3):

1. D1 highway, Predmier - four-lane road, surface - stone mastic asphalt (SMA);
2. II/507 Bytca, bypass road - two-lane road, surface - stone mastic asphalt (SMA);
3. I/18 Zilina, city through road - four-lane road, surface - asphalt concrete (AC);



Fig. 3 Scheme showing localisation of measuring positions around the city of Zilina

4. I/18 Dolny Hricov - two-lane road, surface - asphalt concrete (AC).

Dependency between temperature and particulates concentration was shown at the monitored positions (Figs. 4 to 7), but no dependency between average values of particulates formed and total traffic volume was proven. This can be proven, for example, by the monitored section No. 4 in Dolny Hricov with the D1 highway opened early in 2008, so traffic volume at the I/18 road significantly decreased, but with no effect on PM10 particulate concentration (Fig 7).

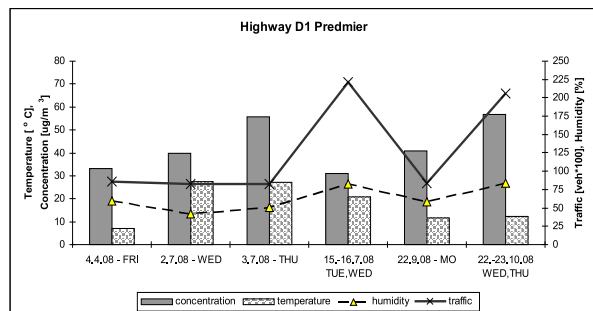

Fig. 4 Long-term observation at the measuring position 1, D1 highway, Predmier

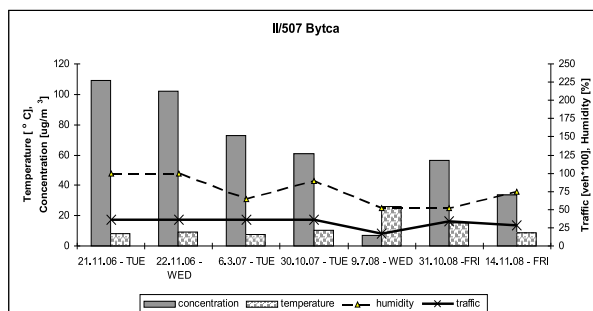

Fig. 5 Long-term observation at the measuring position 2, II/507 road, Bytca bypass

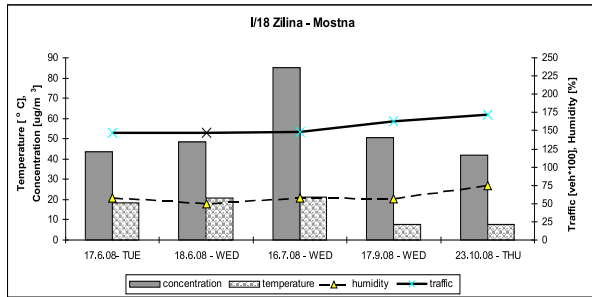

Fig. 6 Long-term observation at the measuring position 3, I/18 Zilina city through road

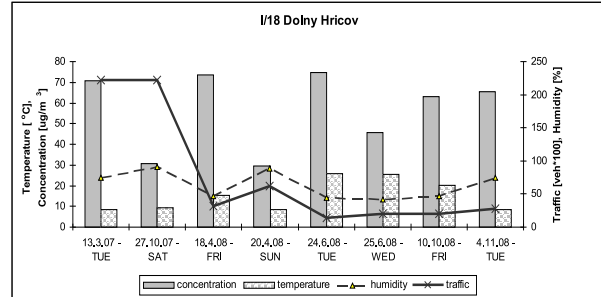

Fig. 7 Long-term observation at the measuring position 4, I/18 road Dolny Hricov



Fig. 8 Measurement at the roadway position 4 Dolny Hricov (on the left)



Roadway surface, asphalt concrete ACo roadway surface 11 - 15 years old (on the right)

Continuous control measurements were made using mobile monitoring equipment in cooperation with ENVItech, s.r.o. Trenčín (Figs. 8 to 9). However, traffic count was done only manually during the continuous measurement. This partial measurement, on the contrary, indicates an interim dependency between the currently increasing traffic volume and the amount of PM concentration.

2. Comparison of Surfaces on the Basis of their Qualitative Parameters

Measurements of roadway surface roughness and analysis of surface pavement compound were done on measuring positions 2 and 4. The measurements support results presented on monitoring



Fig. 9 Measuring at position 4 after laying down the new surface (2 weeks old); Mobile monitoring equipment by ENVItech Trenčín on the right

of particulate matter composition depending on surface pavement type.

Average results for roughness from two repeated measurements taken by Profilograph GE representing thickness of macrotexture surface are as follows:

- Mastic asphalt surface (SMA) was found to be MPD = 0.95... i.e. the surface is visually rougher, its grain size is larger;
- Asphalt concrete (AC) was found to be MPD = 0.42... i.e. the surface is visually smoother with fine grain size.

This corresponds also to composition of the asphalt compounds: SMA - 20% share of fine fraction up to 2 mm; AC - 50% share of fraction up to 2 mm.

Roughness measurements by the profilograph were taken also at position 4, observing differences between the original roadway surface and the newly laid pavement surface (made from asphalt concrete again).

Average results for roughness from two repeated measurements taken in August 2008 show that the new surface is better in terms of quality and rougher:

- the newly laid asphalt surface (AC/new) was found to be MPD = 0.80;
- the original asphalt surface (AC/old) was found to be MPD = 0.38.

When the new pavement surface was laid down, formation of particulate matter was reduced, probably due to a better bond between the fine aggregate and the binding material (Fig. 10).

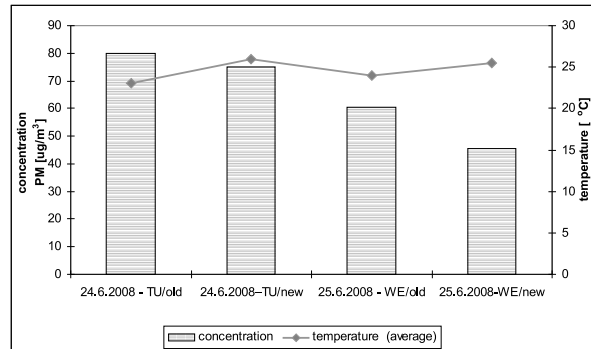

Fig. 10 Comparison of measurements of particulate matter concentrations on the original asphalt surface and the newly laid one at the Dolny Hricov position

3. Chemical Analysis of Samples

Chemical analyses of samples taken at position 1 were done to determine content of selected metals (ICP/MS, Agilent 7500ce). The aim was to identify differences in PM composition resulting from operation of vehicles on roads with different surfaces. To evaluate metal content in PM10 fraction we cooperated with Centrum dopravního výzkumu Brno (Brno Transport Research Centre).

It is assumed that inorganic particles are formed only by abrasion of cement-concrete pavements. These particles therefore represent 90% of the particles resulting from abrasion of asphalt-concrete pavements [4] and they consist mostly of coarse fraction PM.

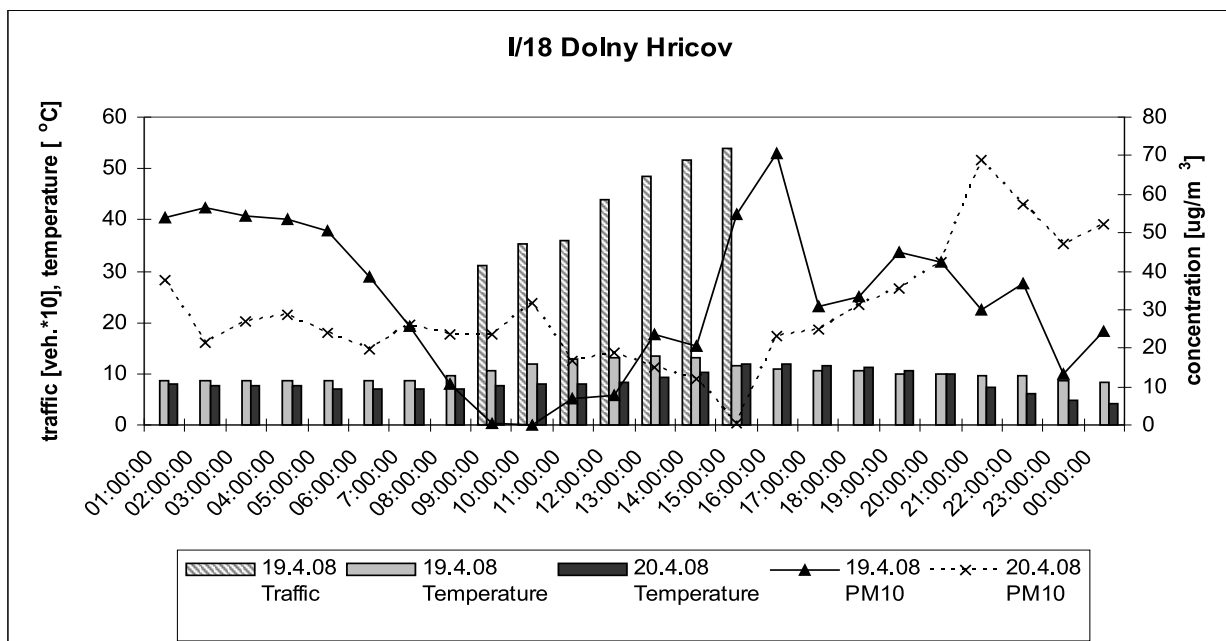

Fig. 11 Course of dependency between particulate matter PM10 formation and air temperature (position 4 - Dolny Hricov)

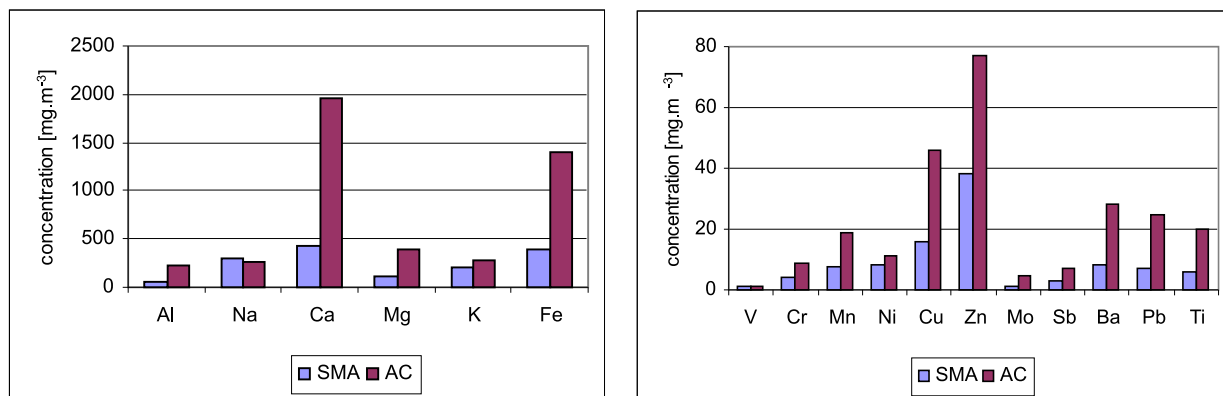

Fig. 12 Content of selected substances in PM10 fraction - position 1 - 1/18 Zilina through road [1]

Contents of selected metals, representing sources related to mechanical abrasion of particles, such as Zn, Sb, Cu, Ba and other, were identified in both fine and coarse PM fractions. Contents of selected metals in both PM fractions were higher at sites with asphalt-concrete pavement at both collection campaigns, except K and Pb in the second collection campaign in the autumn (Fig. 12).

4. Discussion about Results

According to foreign studies, abrasion of tyres, brake shoe lining and roadway contributes significantly to non-combusted traffic emissions. For example [6] or [7] suggest that the share of non-combusted PM10 emissions in total traffic pollution is 50% at present and 50% comes from combustion processes. Considering the renewal of vehicle fleets and use of new fuel types it is likely that the share of non-combustion emissions will become higher.

Analysis of principal components (PCA) for emission source quantification in transport was done by [5]. A component analysis transforms initial variables into orthogonal quantities summarising variances of the initial variables. However, it is up to interpretation whether these new components represent artificial characteristics or whether they reflect real factors.

Thurston [5] specifies the substances that achieve the highest component values. For tyre and brake shoe lining abrasion, these

are benzothiazole, zinc (Zn), copper (Cu), antimony (Sb), titanium (Ti), nickel (Ni); for roadway abrasion, these are nickel (Ni) and vanadium (V); and calcium (Ca), aluminium (Al) a barium (Ba) in case of resuspension.

Based on the chemical analysis done at measuring stations (Fig. 12) it can be assumed that the data obtained on higher Ca, Zn, and Cu values among the chemical substances monitored show that the particulates captured in flow pump filters can originate from tyre and brake shoe lining abrasion and resuspension. The share of road surface abrasion is negligible. Comparison of effects of roadway surface clearly shows that abrasion of components was higher on a roadways made from asphalt concrete than on roadways made with mastic asphalt surface.

These are just partial results of our research work. The monitoring should be complemented by other measurements to have sufficient number of samples for a relevant statistical evaluation. This research work is under way.

Acknowledgement:

This contribution is the result of the project implementation: Centre of excellence for systems and services of intelligent transport, ITMS 26220120028 supported by the Research & Development Operational Programme funded by the ERDF and in terms of the scientific research task VEGA 1/0673/08 Impact of Roadway Serviceability on Road Traffic Immissions.

Share of specific transport sources to PM10 based on evaluation by Principal Component Analysis (PCA) (Thurston, 1983) Table 1

Share	Unidentified source	Diesel combustion	Petrol combustion	Re-suspension	Abrasion of tyres and brakes	Abrasion of roadway
%	7.9	25.0	21.6	10.7	22.6	12.2



Agentúra
Ministerstva školstva, vedy, výskumu a športu SR
pre štrukturálne fondy EÚ

“Podporujeme výskumne aktivity na Slovensku/Projekt je spolufinancovaný zo zdrojov EÚ.”

References

- [1] DURCANSKA, D., HUZLIK, J., LICBINSKY, R.: *Monitoring the Effects of Pavement on Composition of Particulate Matter*, Sustainable development and bioclimate. In: Reviewed proc. from the scientific international conference. The High Tatras: Stara Lesna, 2009, Geophysical Institute of the SAS, ISBN 978-80-900450-1-9, pp.193–194.
- [2] FULLER, G.W., CARSLAW, D.C., LODGE, H.W.: An Empirical Approach for the Prediction of Daily Mean PM₁₀ concentrations. In: *Atmos. Environ.*, p. 36, 1431–1441, 2002.
- [3] HAIDER, M. et al.: *Guidelines for the Environmental Assessment of Various Pavement Types Including Recommendations to Roads Authorities in NMS*, In: WP5 Environmental Assessment, Sustainable Pavements for [1] European New Member States, Activity report, Vienna, p. 97, 2009.
- [4] SNILSBERG, B., MYRAN, T., UTHUS, N., ERICHSEN, E.: *Characterization of Road Dust in Trondheim, Norway*. In: Proc. of the 8th International Symposium on Cold Region Development, ISCORD. Tampere, Finland, 2007.
- [5] THURSTON, G.D.: *A Source Apportionment of Particulate Air Pollution in Metropolitan Boston*, Doctoral dissertation, Dept. of Environ. Health Sci., School of Public Health: Harvard University: Boston, Massachusetts, 1983.
- [6] BOULTER, Paul: *Non - exhaust Particle Emissions from Road Vehicles*, Paper presented at COST 364 PARTICULATES & ARTEMIS dissemination event, Antwerp, 2004.
- [7] LOHMEYER, A., BACHLIN, W., DURING, I.: *Modelling of Vehicle Induced non Exhaust PM₁₀ Emissions*. Paper presented at PM Emission Inventories Scientific Workshop, Lago Maggiore, Italy, 2004.
- [8] STN EN 12341: *Ochrana ovzdušia* [Air Protection]. Determination of PM₁₀ Fraction of Suspended Particulate Matter, 2001 (in Slovak).
- [9] STN EN14907: *Ochrana ovzdušia* [Air Protection]. *Vonkajšie ovzdušie* [Ambient Air]. Standard Gravimetric Measurement Method for the Determination of the PM_{2.5} Fraction of Suspended Particulate, 2005 (in Slovak).
- [10] STN ISO 10473: *Ochrana ovzdušia* [Air Protection]. *Vonkajšie ovzdušie* [Ambient Air]. Measurement of the Mass of Particulate Matter on a Filter Medium. Beta-ray absorption method, 2003 (in Slovak).

Martin Bartovic – Marek Drliciak *

INFLUENCE OF CAPACITY RESTRAINT FUNCTIONS ON TRAFFIC DISTRIBUTION AND THEIR PRACTICAL USE IN THE TRAFFIC MODELLING

The article deals with the issue of capacity restraint functions (curves) determining for roads and their use in the transport model. It describes the procedure for obtaining traffic flow characteristics and the derivation of the parameters needed to create basic restraint BPR function (Bureau of Public Roads). New parameters were then used in traffic assignment process. The impact of parameter changes for routes redistribution on traffic network was evaluated in detail.

The practical use of BPR function in the real traffic model is described in the second part. The article presents the method of volume-delay function definition for different model links types.

1. Introduction

Traffic assignment is the fourth and last major step of the traditional four-step process of transport modelling. This includes assignment of vehicle and person trips. The assignment of trips to the network is the final output of the modelling process.

Historically, highway and transit assignment procedures were used primarily for system analysis of large scale transportation improvements. A single volume-delay function for all facility types of roadways, the Bureau of Public Roads (BPR) curve, was used to estimate link travel times resulting from the assigned volumes. In recent years, a number of enhancements have been made to the process, due in part to increases in computing power. Volume-delay functions have been developed for different facility types (freeway versus arterial, for example). The detail of the coding of the networks has increased dramatically, along with the associated reduction in the size of the traffic analysis zones. Better assignment algorithms (such as equilibrium assignment) and parameters have produced improved results [1].

2. Volume delay function in general

Volume-delay functions (VDFs) describe the speed-flow relationships in a travel demand model network based on the available link capacity. As traffic increases on the network, the resulting travel time and delay increase. In an effort to better represent delay due to congestion, some study areas estimate alternative volume-delay functions or construct speed-flow relationships based on

observed data to achieve reasonable congested weighted speeds from the trip assignment mode [2].

In most traffic assignment methods, the effect of road capacity on travel times is specified by means of volume-delay functions $t(v)$ which expressed the travel time (or cost) on a road link as a function of the traffic volume (V). Usually these functions are expressed as the product of the free flow time multiplied by a normalized congestion function.

$$t_v = t_o * f\left(\frac{V}{q}\right), \text{ where} \quad (1)$$

t_o – free flow time,

V – volume,

q – capacity (it may be full capacity, capacity on the level or saturation flow).

The function should have several conditions. For the formulation of VDF the conditions can be divided into two groups – mathematical and behavioural [3].

Mathematical

From the mathematical point of view, having in mind the system optimal principle, the function should be [3]:

- continuous,
- strictly increasing,
- non - negative.

Behavioural

Following facts should be kept in mind [3]:

* Martin Bartovic¹, Marek Drliciak²

¹ Centre of Excellence in Transport Engineering, Civil Engineering Faculty, University of Zilina, Slovakia, E-mail: martin.bartovic@uniza.sk

² Department of Highway Engineering, Civil Engineering Faculty, University of Zilina, Slovakia

- in urban traffic most of the trips are made everyday – users have a lot of experience with traffic conditions in different times of the day on different routes,
- the user can make also “on-time” decisions – if he sees there is a congestion on the street in front of him or when he hears about congestion on the radio, he can turn and choose another route,
- time spent in the congestion weighs much more for the user than travel time at an acceptable speed – the user is strongly forced to choose another route,
- free flow speed – ex definition as a speed without any disturbances on the road, it decreases after implementing the traffic lights, but many users choose a route having in mind the real free flow.

3. Measurement of traffic flow characteristics

The interdependence of the traffic flow characteristics as the speed (S), volume (V) and density (D) is necessary for the derivation of the VDF function. It is not easy to obtain the mentioned characteristics by the traffic survey. It could be calculated from the continuity equation (equation 2). This equation includes speed and time gap of each vehicles.

$$V(x,t) = S(x,t) \cdot D(x,t), \text{ where} \tag{2}$$

- $V(x,t)$ – volume,
- $S(x,t)$ – speed,
- $D(x,t)$ – density.

The measured data of traffic characteristics on Obvodova Street in Zilina are listed as a practical example. The measurements were performed continuously for a period of 168 hours from Monday to Monday in March 2009. Obvodova street is a two-lane for the adjacent settlement and civil amenities Fig. 1.

The radar equipment SR 4 (Fig.1) was use for measurement of the necessary traffic characteristics (traffic flow statics). The device operates on the principle of the Doppler phenomenon. The change of the wavelength (frequency) of electromagnetic or acoustic waves is caused by movement of the source and observer. It could capture a vehicle speed between 8 and 255 km/hour with the accuracy of 3% for the speed, 20% for a vehicle length and 0.2 s for a time gap.

During the survey a total sum of 66,700 vehicles was recorded. The greatest 24 hour volume was measured in the afternoon hours on Friday, 3/13/2009.

An example of graphical evaluation of the transport characteristics relationship for the single traffic flow (one direction) on the Obvodova Street is shown in Figs. 2-4.

The relations between traffic flow volume and density (Fig. 2), between speed and density (Fig. 3) and between speed and volume (Fig. 4) illustrate the large dispersion of calculated values. The measured data were statistically evaluated and thereafter customized by the obtained standard deviation $\sigma = \pm 0.13$ to the form $x \pm \sigma$. The traffic flow quality on the road during the survey was also evaluated based on the function course [5].

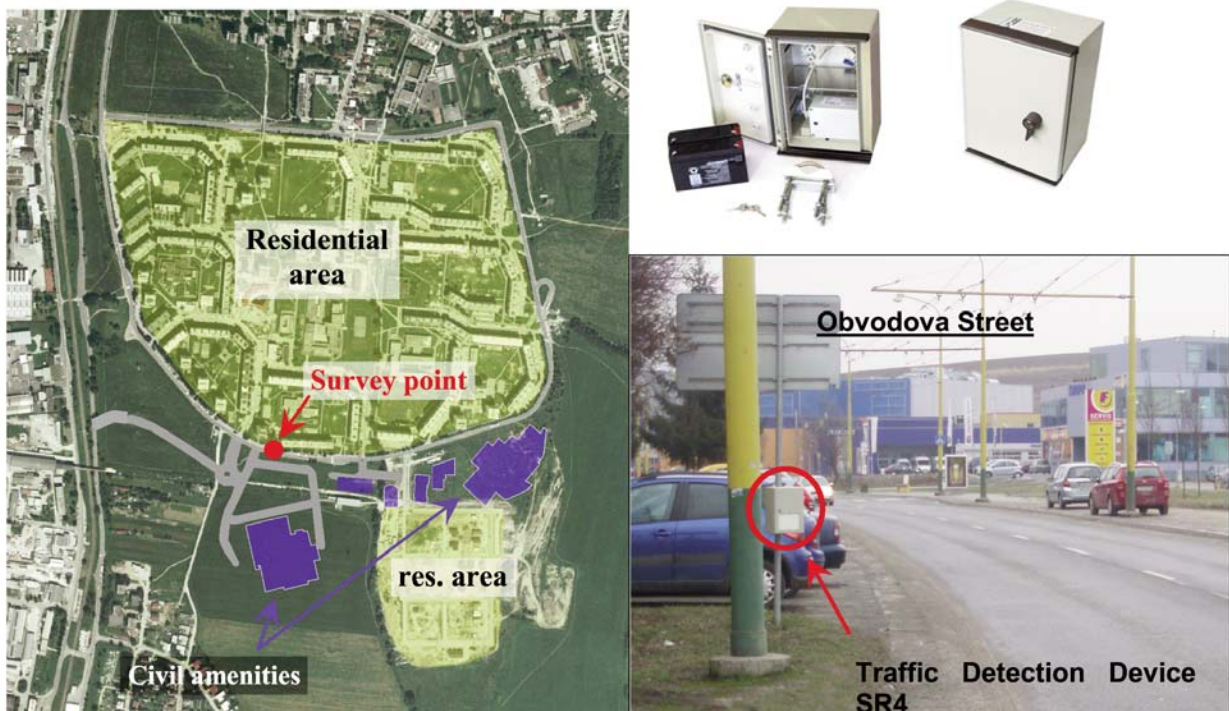

Fig. 1 Location of Traffic detection device SR4 on Obvodova Street

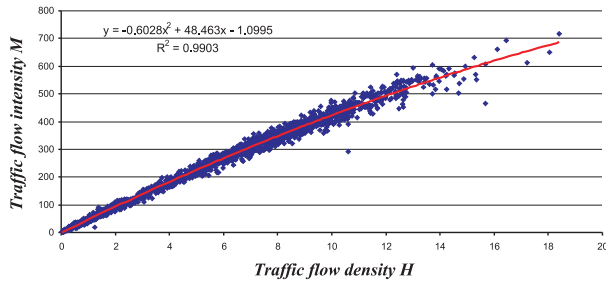

Fig. 2 Relation between traffic flow volume and density

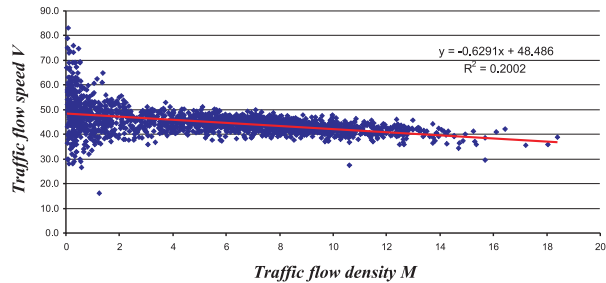

Fig.3 Relation between traffic flow density and speed

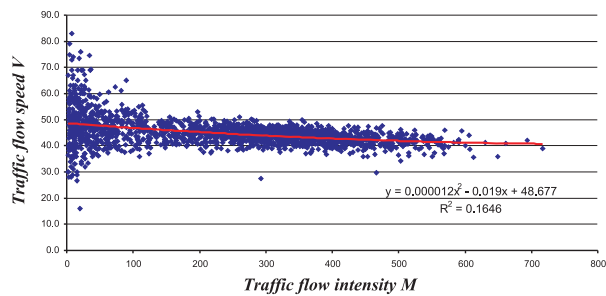

Fig. 4 Relation between traffic flow volume and speed

The function of the volume-density relationship has an increasing tendency. That means that the lane capacity was not exceeded

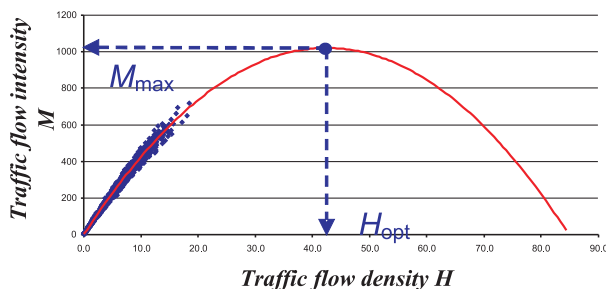

Fig. 5 Extrapolation of the relation between traffic flow volume and density

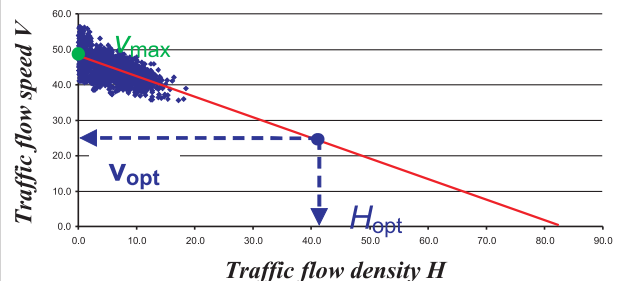

Fig. 6 Extrapolation of the relation between traffic flow speed and density

during the survey. The maximum volume was estimated by extrapolation of the calculated data (Fig. 5). In this case V_{max} is approximately 1000 vehicles per hour. The value of optimal density is x coordinate of V_{max} point and it presents 42 vehicles per km. The maximum (free flow) speed was set by extrapolation of the function of speed - density relationship. In this case S_{max} is approximately 48 km per hour (Fig. 6). The value S_{max} could be also obtained by using a regression equation of the trend curve.

4. The determination of BPR function

Many different types of volume-delay functions (or capacity restraint function CR-function, Fig. 7) were proposed and used in practice in the past. By far the most widely used volume delay functions are the BPR functions, which are defined as

$$t^{BPR}(v) = t_o * (1 + a * sat^b), \tag{3}$$

where

t^{BPR} = t_{Cur} - BPR flow time, (current flow time),

t_o - free flow time,

sat - saturation,

a, b - parameters.

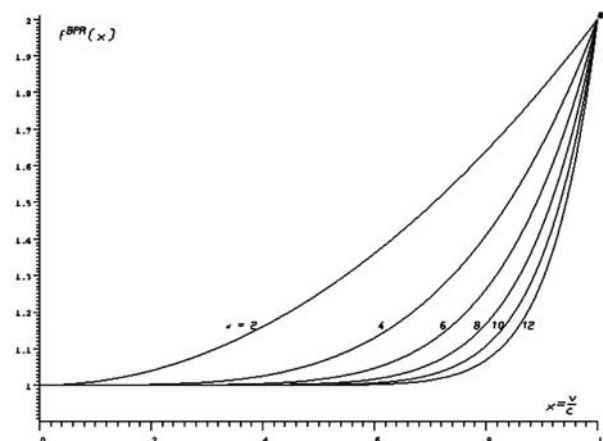

Fig. 7 Example of BPR functions for small v/c ratios

The volume-delay function, i.e. dependence of travel time on saturation, was processed according to the basic shape of the volume-delay function BPR (equation 3). This relationship is graphically shown in Fig. 8. The target trend line of calculated values is the looking volume-delay curve (capacity restraint curve).

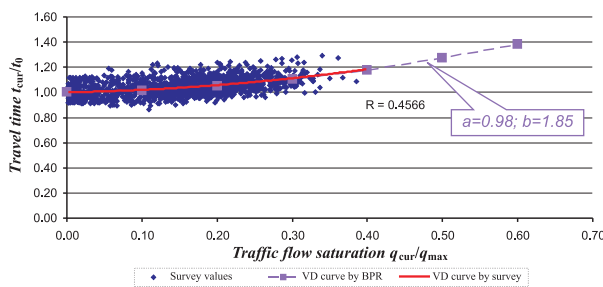

Fig. 8 Volume-delay curve after interval modifying to $x \pm \sigma$

Travel time was calculated based on equation (4):

$$\frac{t_{cur}}{t_0} = \frac{r}{s_{cur}} = \frac{s_0}{s_{cur}} \implies \frac{t_{cur}}{t_0} = \frac{s_0}{s_{cur}}, \text{ where} \quad (4)$$

- s_{cur} - current vehicle speed,
- s_0 - free flow vehicle speed,
- r - route length = constant,

The values of parameters a and b of the trend line were found iterative. The value of parameter c was equal to 1. The new found parameters are [5]:

$$a = 0.98 \quad b = 1.85$$

Traffic flow in the opposite direction was determined by the same process and the parameters of volume-delay curve were found [5]:

$$a = 0.89 \quad b = 2.11$$

The results in this example show that the VDF (their parameters) are different not only for different types of routes, but also for driving directions.

The obtained results will be used in the transport model, in this case specifically in the PTV Vision-Visum program.

5. Restraint functions in Visum

VISUM is a program for computer-aided transport planning which serves to analyze and plan a transportation system. The transportation system includes private and public transport supplies (PrT and PuT) and travel demand. VISUM supports planners to develop measures and determines the impact of these measures.

In loaded networks, the link travel time and the turning time is determined by volume-delay function "VDF". This VDF describes the correlation between the current traffic volume v , and the capacity q_{max} . The result of the VDF is the travel time t_{Cur} in the loaded network. VISUM provides several types of volume-delay functions [4]:

1. the BPR function from the American Bureau of Public Roads (Illustration 28),
2. a modified BPR function with a different parameter b for the saturated/unsaturated state,
3. a modified BPR function with an additional penalty parameter d regarded for each vehicle in the saturated state,
4. the INRETS function developed by the French Institute National de Recherche sur les Transports et Leur Sécurité.

The time t_{Cur} of a network object is calculated with volume-delay functions. Based on the assumption that the travel time (impedance) of network objects increases with increasing traffic volume, all assignment procedures are in turn based on the assumption that travel times of network objects are a monotone incremental function of traffic volume.

PTV-Visum program works with the default VDF setting as a function of BPR with the parameter values $a = 1$, $b = 2$ and $c = 1$ for all types of roads. But it allows changing this setting and identifying the parameters for a previously defined road types (model calibration) - Fig. 9.

The links are defined as Global type (0* - 9*) or Types (00 - 99) in Visum. Every type of the link has attributes that have to be defined. Default values can be defined for the following attributes: name, rank, capacity - PrT in passenger car units, number of lanes, v0-PrT, vMin-PrT, transport system, max. speed and road toll by transport modes.

For example the traffic model of Zilina, which was created on the department of highway engineering, has defined six main global types of links. We used only two types of the volume delay function with default setting. The optimal setting of all global link types is the question of many future measures (Fig. 10).

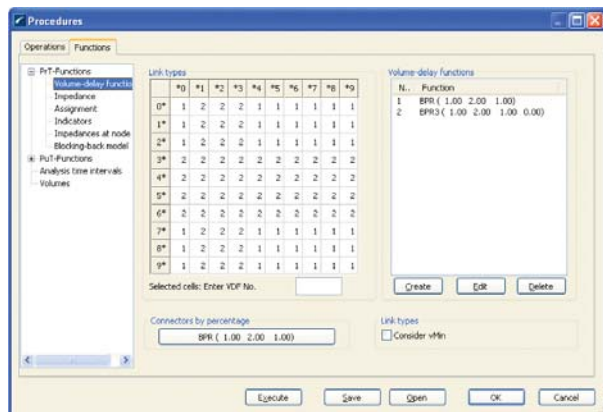

Fig. 9 Definition of volume delay function in PTV Vision -Visum

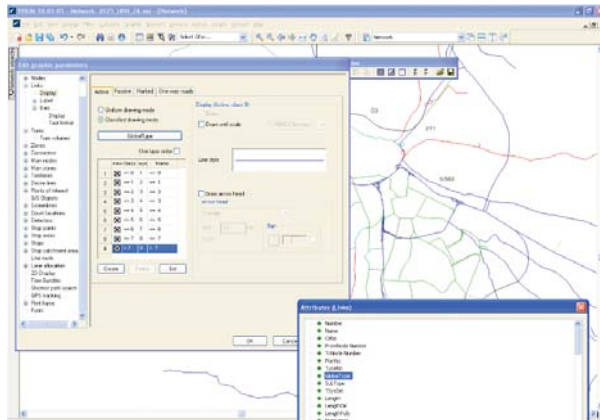

Fig. 10 Definition of global link type

6. Conclusion

The optimal setting of all attributes of the traffic model is a very difficult problem. The volume delay function is the main

factor for calculation of real flow time. Sometimes the final results of traffic volumes are much higher than the capacity (over assignment). The new setting of parameters puts more exact values of the final capacity.

The Visum software allows defined impedance functions for links but it doesn't allow defined impedance functions for directions on the link separately. For this reason the model maker has to use the average values of impedance function parameters. The exact values of parameter could be specified only by a calibration process.

The impedance functions are very useful and important elements in the traffic assignment process and inseparable part of the calibration and validation process.

Acknowledgement:

This contribution is the result of the project implementation: "Centre of Excellence in Transport Engineering" (ITMS: 26220120027) supported by the Research & Development Operational Programme funded by the ERDF.



References

- [1] Model Validation and Reasonableness Checking Manual - 7.0 Assignment Procedures; <http://tmip.fhwa.dot.gov/resources/clearinghouse/docs/mvrcm/ch7.htm>, US Department of Transportation,
- [2] Speed Adjustments Using Volume-Delay Functions; - 7.0 Assignment Procedures; http://tmip.fhwa.dot.gov/resources/clearinghouse/docs/tmip/technical_syntheses/2009/january.htm, US Department of Transportation,
- [3] JASTRZEBSKU, W. P.: *Volume Delay Functions*; 15th Intern. EMME/2 Users's Group Conference; Vancouver, B. C.
- [4] PT_VISION Visum User Manual. Karlsruhe, 2002.
- [5] BARTOVIC, M.: *Modely delby prepravnej prace* [Models for Division of Transport Work], Doctoral thesis, University of Zilina, 2009 (in Slovak).

Maria Trojanova – Katarina Zgutova – Lubomir Pepucha – Martin Pitonak *

INTER-LABORATORY COMPARISON OF ACCREDITED LABORATORIES IN TERMS OF BENCHMARKING IN SLOVAKIA

The overall implementation of active benchmarking - the transfer and implementation of good practice in a closed circle in inter-laboratory comparisons its one of his components. To ensure that mission it's been created inter-laboratory comparisons model for benchmarking - and as a support web system. The system is open to different types of quality indicators and its c showing basics compliance with accreditation requirements.

1. Introduction - Outline of the Term Benchmarking

Benchmarking is a concept that is as old as the Olympics in ancient Greece. Athletes recognised that performance could be continuously enhanced through comparison with others.

Benchmarking is not a standardized method and therefore, in practice, there are a number of definitions. The following two are probably the most widely accepted. The American Productivity and Quality Centre (APQC) [9] which currently represents the leading world benchmarking institution and initiates benchmarking projects long-term [14], defines benchmarking as the process of identifying, learning from, and adopting outstanding practices and processes from any organization, anywhere in the world in order to improve performance [1].

According to the official dictionary of the American Society for Quality (ASQ) [10] benchmarking is a technique whereby a company measures its performance against that of the world's best in class, determines how such companies achieved their level of performance and uses this information to improve its own performance[5].

The Slovak literature [22] states that benchmarking is a continuous and systematic process of comparison and measurement of any products, process or methods in any given organisation that have been deemed suitable for measurement in the attempt to define the goals and to improve the performance of the organization.

2. Civil Engineering Testing in the Slovak Republic

One of the instruments in regulating the market diversity of testing norms in civil engineering as well as the standardization of

civil engineering testing at a professional level, is a process of accreditation whereby testing laboratories must conform to the system and technical requirements of the norm STN EN ISO / IEC 17025 [24]. This norm creates a platform for comparing professional competence and stipulates the conditions for ensuring quality measurements and conditions for assuring quality of measurements.

The current construction environment is characterized by:

- high public demand for quality works;
- fast pace of construction; new entrants in the field of linear works construction;
- budget tensions;
- decline in skilled workers in relation to requirements,

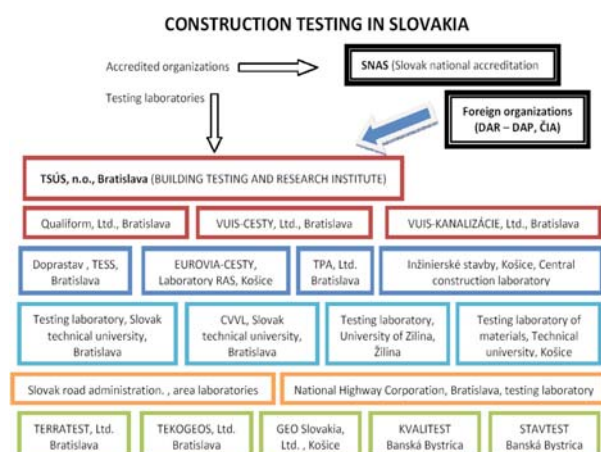

Fig. 1 Schematic representation of Civil Engineering testing in the Slovak Republic

* Maria Trojanova, Katarina Zgutova, Lubomir Pepucha, Martin Pitonak
 Department of Technology and Management, Faculty of Civil Engineering, University of Zilina,
 E-mail: maria.trojanova@fstav.uniza.sk

- the introduction of new technologies and modern methods of testing building materials and construction elements.

Therefore, in the context of active benchmarking, inter-laboratory comparisons are a significant component of the transmission and implementation of good practice in civil engineering. As a result, and in order to achieve high quality inter-laboratory comparisons, a model of civil engineering testing has been created - Fig. 1.

3. Benchmarking Classification

Based on the findings of research, the following benchmarking classification was determined [20]:

- competitive benchmarking - where the subject of interest is a particular product or performance of direct competitors on the market;
- functional benchmarking - where one or several functions of certain organizations are compared;
- generic benchmarking - where the centre of attention is the comparison and measurement of the specific organization's process. This applies to any appropriate organization with a similar process, although it may well not be a direct competitor.

Depending on where the benchmarking is performed, it is classified as:

- Internal - performed within one organization between units which have the same or similar processes and functions;
- External - where the partner for comparison and measurement is a different organization.

4. The Practical Importance of Benchmarking

Benchmarking in general:

- helps to better understand requirements of customers and other stakeholders
- allows managers to obtain information that would otherwise come to light accidentally, or would remain unknown - also helps to dispel unwarranted optimism
- is the way towards the discovery of objective indicators for measuring own performance and productivity in order to accurately identify own strengths and weaknesses,
- is one of the most effective ways of gathering suggestions for improvement.

Benchmarking is not strictly a closed process or a method with clearly defined rules and procedures. The number of stages or steps is very diverse and varies in different companies and organizations from 4 (representing the PDCA cycle - Fig. 2) up to 20 steps. The starting cycle for the application of benchmarking onto accredited laboratories is a four step cycle, with customer involvement as per Fig. 3.

For all professionals in the field of quality management, it is important to note that the draft of the new ISO 9004 incorporates the article 8.3.5 recommendation that benchmarking methods

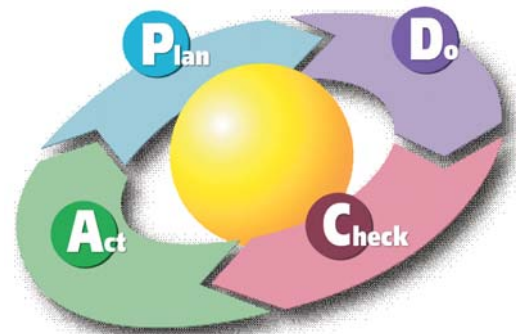

Fig. 2 Benchmarking four-step PDCA cycle [33]

should adhere to clearly defined rules and procedures [14]. It may therefore be expected to supplement the ISO 17 025 which is currently fully compatible with the standards of the 9000 class.

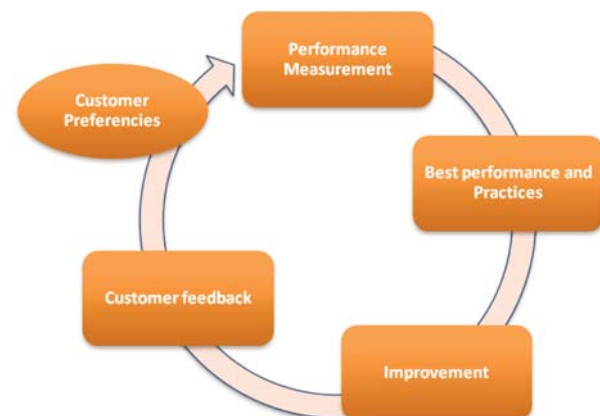

Fig. 3 Customer involvement in benchmarking process

Also, it is likely that benchmarking will become a component of accredited laboratories, thus becoming not only a comparison in the area of test results, which are subject of inter-laboratory comparisons, but also in the system section, which is also supported in the ISO/IEC 17025: 1999 point 5.9.

The laboratory shall have quality control systems to monitor the validity of the tests and calibrations undertaken. The data collected has to be recorded in such a way as to identify trends and, where feasible, to use statistical methods to assess results. This monitoring has to be planned and controlled, and may include, but not be restricted to, the following: participation in inter-laboratory comparisons or competence testing projects.

As a result of these developments, a benchmarking tool is proposed: - a web portal which is to be an open system for different types of quality indicators. The only valid outcome for any process of benchmarking is to identify areas for self improvement. It is the implementation of projects of improvement which gives benchmarking a meaning.

5. Benchmarking in testing laboratories

There are three basic prerequisites for customer oriented benchmarking in testing laboratories [6]:

1. **Leadership.** Customer oriented benchmarking, in the most cases requires a complete reorientation from thinking in the terms of maintenance resources, production and activities, to thinking in terms of providing a product and service that are important for the customer; whilst, at the same time, thinking in terms of efficiency and performance related to products and services. Such reorientation requires strong support from the management. Without leadership, moving towards customer-oriented benchmarking will not be successful. Another aspect of good leadership is to bind the organization to the benchmarking. Time, effort, labour resources and attention to the data required from each laboratory should not be underestimated. It is necessary to use the same performance measurements for all the benchmarking partners; however, it is very likely that the data will not be uniform at the start. Data should be collected in accordance with a specific plan. The practices at all levels of any given laboratory must be documented and shared with the benchmarking partners; especially if these have a different organisational structure. It is also necessary to make a commitment to implementing the ideas emerging from benchmarking and ensure that goals are actually achieved. It should also be borne in mind that performance measurements and new practices will mean re-deployment of resources within a laboratory
1. **Culture.** The culture of the work environment must support the idea of continuous quality monitoring and improvement. Customer oriented benchmarking requires a culture which is not always satisfied with the status quo and does consider it set in stone. Prior to starting benchmarking, it is helpful to view change and comparison with others as a way of improving the product and service for the customer. Management should monitor and analyse successes, reward improvements and genuine effort and be able to rapidly spot failures.
2. **Common indicators.** Participants in customer orientated benchmarking must agree with the measurements to be used. It is much easier to find a consensus about measurements within a laboratory than to accept external standards.

6. Benchmarking indicators and their units

Benchmarking indicator indicates to what extent the laboratory achieves the performance of competition

$$U_b = \frac{P_v}{P_{vk}} \cdot 100 \tag{1}$$

where:

- U_b - benchmarking indicator [%]
- P_v - characteristic parameter of performance of own organisation
- P_{vk} - identical parameter of performance of the competition

The increasing value of this indicator and its permanently getting closer to 100% is obviously a positive trend [2].

This part is one of the key outcomes and suggests a *catalogue of measurable indicators suitable for benchmarking of accredited laboratories - orientated to the customer* - purchaser together with units. These indicators are those that are directly or indirectly relevant to the customer, however, there are many other measurements that are already recognized or are still to be identified.

The measurements are divided according to elements - items required for accreditation and then by attributes, where are associated measurements and their units and the note. The catalogue should include *items* such as the following:

1. Sampling
2. Validation of methods
3. Data control
4. **Assurance of quality tests results** - this is the only indicator that is measured within the scope of inter-laboratory comparisons
5. Complaints
6. Personnel
7. Handling the testing items and other.

Indicators of selected items are identified by:

- professional assessment
- brainstorming
- studying professional literature
- cooperation with accredited laboratories staff

It is an open system where items are associated with attributes, methods of measuring and units, as for example:

Quality indicators example Table 1

Attribute	Measuring	Units	Note
Homogeneity of the sample	Standard deviation	Quadrante of evaluated parameter	Procedure which is carried out by the laboratory and its instruments
Discordant sample	Average number of non-homogeneous samples	Number	Procedure which is carried out by the laboratory and its instruments

Benchmarking costs:

- Costs of meetings - include the costs of overheads. This includes travel, accommodation, per diem allowance and other costs,
- Costs of time - benchmarking team participants invest their time to review the problems, to find suitable and willing partners, time for mutual visits, not to mention the time for analysis and implementation. All this means that participants are absent from their work, and must be replaced by auxiliary workers,
- Costs of benchmarking database - an organization that wishes to introduce benchmarking into the daily process must create and maintain a database of their benchmarking results, and the best results of participating organizations.

7. Web Portal as a Basic Benchmarking Tool

Web portal for benchmarking emerged as a result of the practical need to make the execution of inter-laboratory measurements more efficient. The system for benchmarking of accredited laboratories is designed and intended for comparative purposes. Its applicability is therefore far broader. It can also be used for comparison in other sectors of construction and by other construction works operators.

Starting Points for the Emergence of the Portal

The starting point for designing the system was that it should be flexible and useful for comparing all types of laboratories at all levels, to be used not only within the Slovak area, but also in Europe. If need be, it can serve a single organization, such as the National Motorway Company - at the level of motorway construction, as a tool for selecting an accredited laboratory.

Due to the reasons listed, it is possible to expect a large range of different types of indicators, parameters and categories that require different entries. Therefore, the starting point in creating the system was the design of forms by an administrator, with the relevant number of columns and rows to record units, as desired. The representatives of laboratories have to enter basic information about the laboratory and, subsequently, parameters they have measured and the basic characteristics of the testing environment. These characteristics can be edited by the administrator.

Benchmarking participants, after permission to register, have to fill in individual forms designed by the administrator.

Participation of laboratories in benchmarking process provides objective evidence about the reliability of the results [26] they produce, allows them to identify sources of potential errors and subsequently to improve the quality of their work. The motivation of individual entities is the need to compare the results of their own work with other laboratories (partners but also competitors).

Participation of laboratories in competence testing and comparative measurements is an important part of *showing compliance with the accreditation requirements*. It is one of the key criteria to fulfil the accreditation requirements of accredited laboratories [24]. For this reason, it is very important that laboratories, in their own interest, participate in such competence tests and comparative measurements.

Company Calibrum, Ltd., in conjunction with the Faculty of Civil Engineering at the University of Zilina, organizes the national competence tests and comparative measurements in the field of construction, in accordance with the valid Methodical Guidelines for Accreditation and the Slovak National Accreditation Service, and coordinates the national system of competence testing and comparative measurements aimed at:

- allow, within limits, the individual laboratories to prove compliance with the follow-up and measuring instruments via participation in the competence testing and comparative measurements,

- serve as an effective tool of the Slovak National Accreditation Service for ensuring the comparability of results of testing and calibration activities of laboratories.

On-line application of benchmarking

The basic assumptions the application should meet are:

- multi- platform, namely the independence of the system used by the testing laboratory or other organization,
- accessibility not only via LAN, but also over the Internet (accessible 24 hours a day).

Due to the reasons discussed, the most suitable solution for the customer driven benchmarking appears to be the use of the platform Client - Server, which allows complete separation of the application section from the user section, where the user enters the data and results into the user interface on his or her computer and these are evaluated, processed by a program located on the server.

The connection between the User - Client and Server must be encrypted by SSL protocol, in order to prevent leakage of information that the testing laboratory or other organization is not willing to disclose. In this way, the operating body guarantees the inviolability of the information provided by the testing laboratory for comparison. Implicitly, the table of results with information from testing laboratories will identify the laboratory only as a number, which will be changed regularly and different for each testing laboratory.

Application environment

Due to the diversity of operating systems, software facilities on user computers we applied the environment of web pages for communication of testing laboratories with the server. This ensures trouble free access into the application for all users - testing laboratories. Server hardware is located in an air-conditioned server room, under 24 hour surveillance by security service, camera system, and a system for ensuring constant connection of servers.

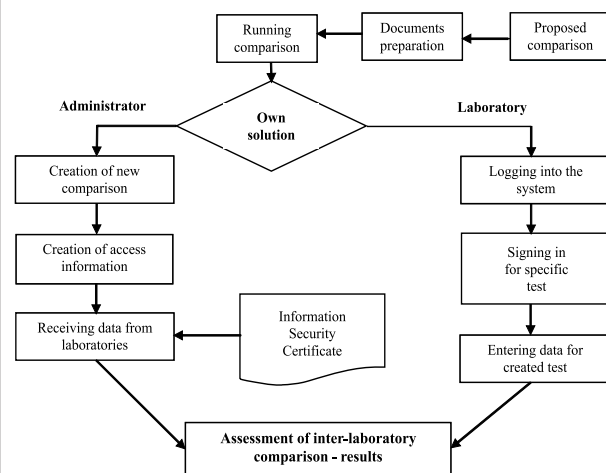

Fig.4 Scheme of on-line comparison process

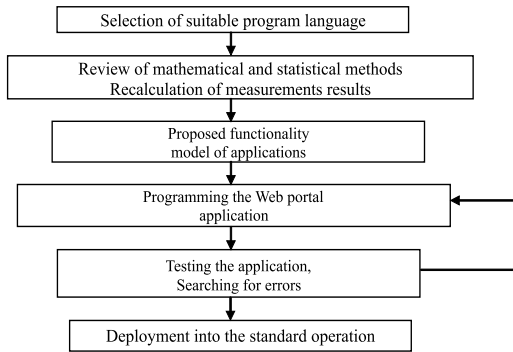
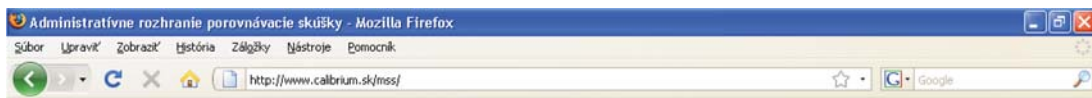

Fig. 5 Scheme of work on creation of web portal application

Web portal user interface

After studying mathematical methods for statistical comparisons of inter-laboratory tests, we started programming the application itself. The body of the application is divided into the following sections for clarity.

- *Logging* into the application, we resolved by an allocation of a unique code, which will be allocated to the particular laboratory by a generator program in order to avoid possible human error. Application users will authenticate themselves by the username and the assigned code. On the server we created a secure connection via HTTPS (encryption by generated, or Certification Authority verified, authoritative certificate). In terms of application users, the highest level of security will be ensured.



vítajte na administratívno rozhraní porovnávacích skúšok

Príhlasovacie meno:

Heslo: Zadať prosím Vaše meno a heslo

Fig. 6 Logging into the application

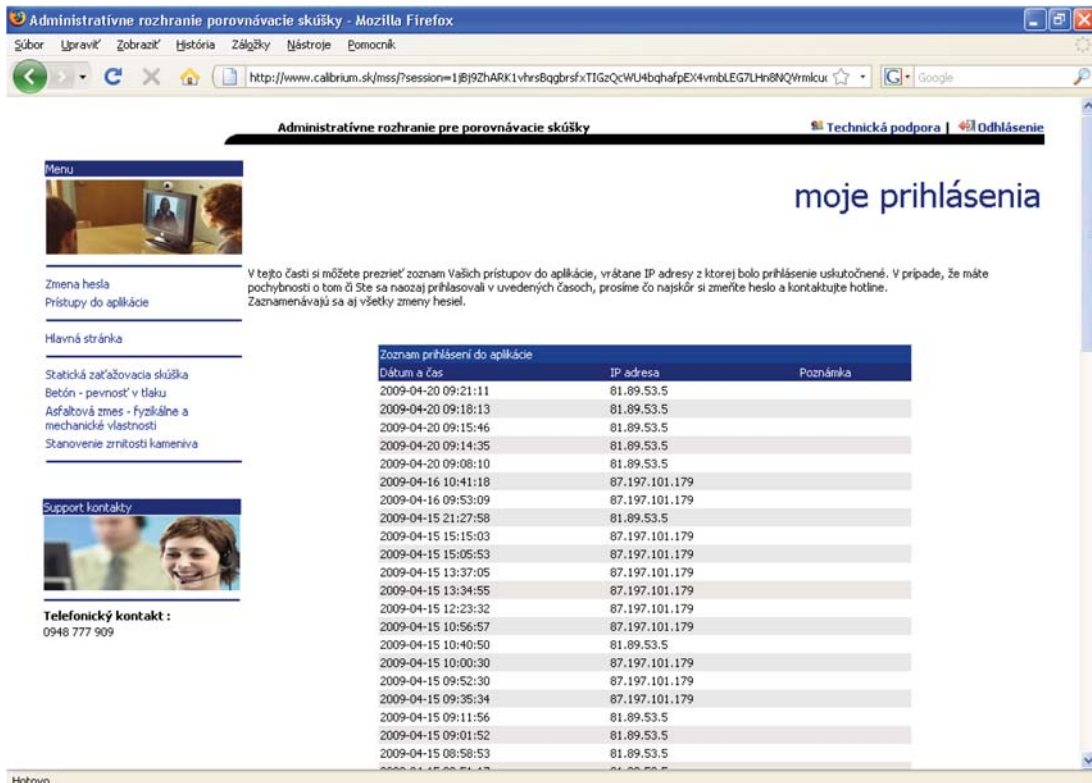

Fig. 7 Recording access to the application

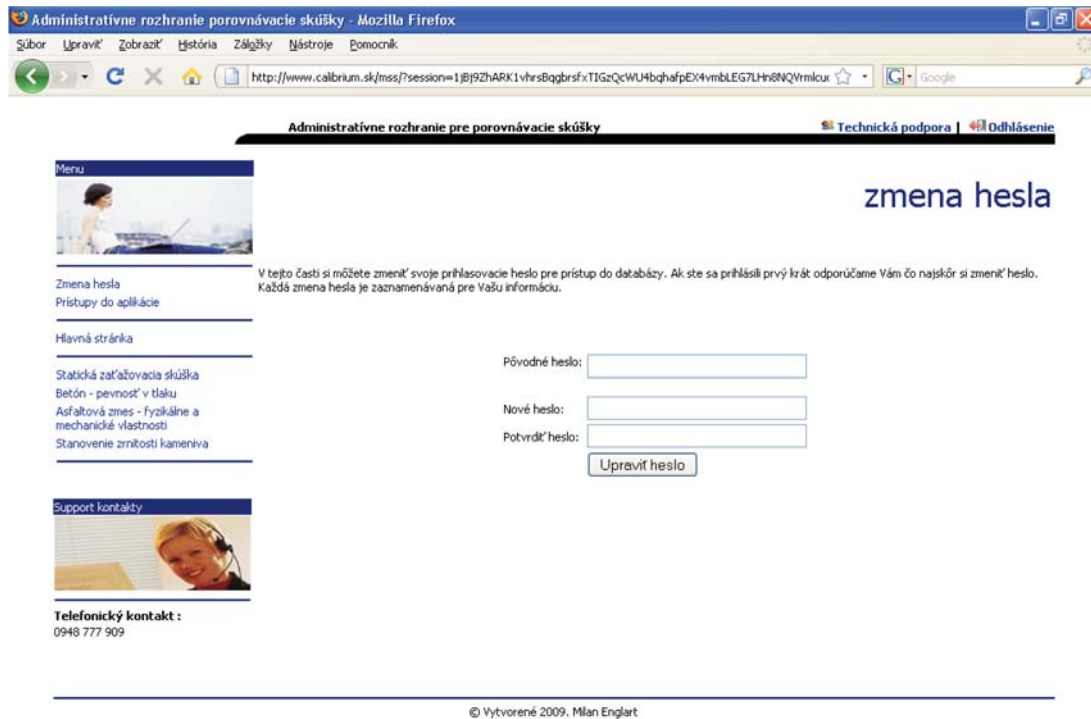

Fig. 8 Option to change the application access password

For authentication of users we incorporated to the application a system for recording the access into the application.

At the same time the database stores IP address from which the application was accessed, password changes and other important data facilitating the detection of potential misuse of access data. Each figure recorded in the database is Time Stamped, thus the time is precisely defined and can not be changed not even by the administrator.

Password change – following successful login, the user has the option to change the password. The minimum number of characters for the password, we selected six characters.

- *Data entry* – we chose a system where an application user selects, in the left hand menu, the test for which she or he wishes to enter the data, for example for the static load test. Following the click on the given item, the form will appear and the user can enter the values measured. In the future we anticipate more



Fig. 9 Method of data entry into the application

benefits in the automatic control of data entered, in order to prevent the entry of diametrically opposed data because of human error.

- *Displaying the results* - if the user enters his or her values for particular measurements and other participants in inter-laboratory comparison have done the same, the evaluation will be displayed. To protect the user data, each user views the results table reshuffled. So even if 2 users agree that they will provide the results table to each other, it will not be identical, the arrangement of laboratories will be different.
- *Trial testing* - we created a group for testing the web application. Each participant was assigned a unique code for the laboratory test. The user logged into the application under her/his name and password and entered the value measured, specifically for Concrete - compressive strength. Unfortunately, some participants were not familiar enough with the system and entered incorrect values, and therefore it was necessary to send them

the information about re-entering the results into applications. This delay meant that the outcome of inter-laboratory comparison was not evaluated in the expected time frame. However, we see the possibility of adjustments in the future.

- *System Adjustments* - during the simulation of the inter-laboratory comparison minor errors appeared and are currently being remedied; this mainly concerns:
 - control of input data entry
 - allowing the continuous monitoring of the results of comparison
 - possibility to export the results to PDF, CSV or other.

Acknowledgement:

This contribution is the result of the project implementation: „Centre of Excellence in Transport Engineering” (ITMS: 26220120027) supported by the Research & Development Operational Programme funded by the ERDF.



Agentúra
Ministerstva školstva, vedy, výskumu a športu SR
pre štrukturálne fondy EÚ

References

[1] CAMP, R. C.: *Business Process Benchmarking*. ASQS Quality Press. Milwaukee, 1995, p. 464, ISBN 0-87389-296-8.

[2] DOUGLAS, C., MONTGOMERY: *Introduction to Statistical Quality Control*. Third edition, ISBN 9780471303534, Publisher John Wiley & Sons Inc.

[3] Draft FDIS ISO 9004-N6 (17/04/2009). Geneva ISO 2009.

[4] ENGLART, M: *Medzilaboratorne porovnavania v ponimani benchmarkingu riadeného zakaznikom* [Inter-laboratory comparisons in terms of customer-driven benchmarking]. Diploma Work, KTMS, SvF, ZU, 2009.

[5] Glossary of terms Related to Quality Management. In: www.asq.org, 10.4.2007.

[6] HARRINGTON, H. J., HARRINGTON, J., S.: *High Performance Benchmarking, 20 Steps to Success*. McGraw-Hill : New York, NY, 1996.

[7] HOLLOWAY, J., FRANCIS, G., HINTON, M., HAYLE D.: *Best Practice Benchmarking*. TQM 4/1998

[8] <http://en.wikipedia.org/wiki/PDCA>, 18.11.2009.

[9] <http://www.apqc.org/portal/apqc/site>, 17.11.2009.

[10] <http://www.asq.org>, 17.11.2009

[11] <http://ww1.efqm.org/en>, 17.11.2009.

[12] MIKOLAJ, J., SCHLOSSER, F., VALUCH, M., ZGUTOVA K.: *Zavedenie systemu kvality v oblasti vystavby, udrzby a oprav ciest* [Introduction of quality management system in the field of road construction and maintenance]. Report No.6-3/83/SvF/03, University of Zilina.

[13] MSA 0113-98 Skusky sposobilosti. Cast I. *Zasady vyberu, organizovania a hodnotenia skusok sposobilosti SNA* [Competence Tests. Part I. Principles of selection, organization and evaluation of competence tests SNA]. SNAS, p. 34, Bratislava April 1998.

[14] NENADAL, J.: Jak zacit s Benchmarkingem? [How to start with benchmarking?]. Part 1. In: *Quality 2/2009*, ISSN 1335-9231, pp. 22-29.

[15] NENADAL, J.: Jak zacit s Benchmarkingem? [How to start with benchmarking?]. Cast 2. In: *Quality 3/2009*, ISSN 1335-9231, pp. 17-23.

[16] NENADAL, J.: *Mereni v systemech managementu jakosti* [Measuring in quality management systems]. 2nd ed. Management Press: Praha 2004.

[17] NENADAL, J., NOSKIEVICOVA, D., PETRIKOVA, R., PLURA, J., TOSENOVSKY, J., VYKZDYL, D.: *Jak zvyisit vykonnost organizaci* [How to increase organization’s performance]. Ostrava : Dum techniky, 2008, p. 239, ISBN 978-80-7261-164-5.

- [18] OAKLAND, J., S.: *Oakland on Quality Management*. Amsterdam: Elsevier Butterworth Heinemann. 2004, p. 476, ISBN 0-7506-5741-3.
- [19] PITONAK, M.: *Vyuzitie vybratych metod systemov manazerstva kvality pri udrzbe a opravach cestnych komunikacii* [The use of selected methods of quality management systems at maintenance and repairs of roads]. Thesis, KTMS, Faculty of Civil Engineering, University of Zilina, 2008.
- [20] PITONAK, M., ZGUTOVA, K.: *Nastroj pre benchmarking spracov cestnych komunikacii* [A Tool for benchmarking of road operators]. In: Proceedings from the 17th Intern. Conference: Quality-2008, ISBN 978-80-02-02032-5, Ostrava, 2008, pp. C28-C33.
- [21] SAMUEL, K. M. H.: *TQM, an Integrated Approach*. Implementing Total Quality through Japanese 5-S and ISO 9000, Published in 1995, Kogan Page : London, 0749415614, p. 292.
- [22] STARSI, B.: *Vyznam medzilaboratornych porovnavajucich skusok pri posudzovani sposobnosti skusobnych laboratorii* [The meaning of inter-laboratory comparative tests at assessing the competence of testing laboratories] In: Proc. from 9th Intern. Conference: Road Conference Q-2007, ISBN 978-80-969681-0-7, Zilina, 2007, pp. 177-182.
- [23] STN EN ISO 9004:2001: Quality Management Systems. Guide for efficiency,
- [24] STN EN ISO/IEC 17025:2005: General Requirements for the Competence of Testing and Calibration Laboratories. SUTN Bratislava, 10/2005, p.37.
- [25] SPACKA, M.: Co je a co neni benchmarking [What is and what isn't benchmarking]. In: *Modern Management*, 3/2005. Praha: Economia, 2005. ISSN 1213-7693.
- [26] STEFANIK, A., MICIETA, B.: Benchmarking - indexove porovnavanie [Benchmarking-index comparison]. In: *Modern approaches towards firms management*. Trnava, 2002, STU, pp. 245-249, ISBN 80-227-1706-1.
- [27] TEREK, M., HRNCIAROVA, L.: *Statisticke riadenie kvality* [Statistical quality management]. Bratislava : IURA EDITION, 2004.
- [28] VALUCH, M., TROJANOVA, M., CURAJ, M.: Application of Process Approach in Public Procurement of Highway Projects. In: *Civil and Environmental Engineering*, 1/2008, ISSN 0336-5835, pp. 2-4.
- [29] VLCEK, R.: *Management hodnotovych inovaci* [Management of value innovations]. Praha: Management Press, 2008, p. 239, ISBN 978-80-7261-164-5.
- [30] WAN, E., WAN, J., MOKHTAR, A., NOOREHA, H.: Benchmarking institutions of higher education. In: *Total Quality Management*, 7/2000, Vol. 11, Issue 4/5/6, p. S798, ISSN: 09544127.
- [31] WEBER, R.: The Benefits of Benchmarking. In: *Trailer/Body Builders*, 7/2005, Vol. 46, Issue 9, pp. 82-83, ISSN: 0041-0772.
- [32] ZGUTOVA, K., PITONAK, M.: *Benchmarking v cestnom hospodarstve* [Benchmarking in road economy]. In: Proc. from International Conference - 2006 Road Conference, Rajecke Teplice, 2006.
- [33] W.Edward Deming (1900-1993).

WAITING TIME OPTIMIZATION WITH IP-SOLVER

This paper deals with two different public transport problems, in which the same phenomenon of waiting time occurs. In the past, both the problems were solved in the same way, which included rearrangement of the original problems to simpler max-min problems. These simplified approaches were used due to that time state of optimization software. In connection with building new computational laboratories equipped with new optimization environment, we want to come back to the more precise original quadratic models of the problems and explore new possibilities in obtaining the optimal solution of the original problems. We have done an analysis of those quadratic programming problems, worked out a linearized model and completed the computational study to compare the max-min and quadratic approaches.

1. Introduction

A series of mathematical programming models of transportation problems were formulated and solved in the several last decades to obtain solution of the transportation problems. In those models, regular distribution of time intervals was taken as a quality criterion of searched solutions, even if the original objective was to minimize the total waiting time of passengers or cars in traffic flows. This original criterion was replaced by the criterion of regularity to preserve linearity of the processed mathematical models. This simplified approach was used because of that time state of computation technique, which did not allow complying with non-linear or large linear problems. Furthermore, the criterion of regularity was often simplified to min-max or max-min objective function and so, only the worst time interval of the solved problem was improved by the associated optimization process.

This way, the obtained results were far from the optimal ones in many cases, even if an exact method was used to solve the associated linear programming problem. In this paper, we present two transportation problems with the original and surrogate objective functions and compare the results obtained by solving a simplified model with the max-min criterion and a more precise and larger model, which respects the quadratic criterion. This comparison including the inevitable large problem solving is enabled by exploitation of optimization environment called XPRESS-IVE. Abilities of this tool are also studied in this paper in connection with the necessity to solve much larger linear problems to comply with the quadratic criteria.

2. Max-min approach to the signal plan for light-controlled crossing

Let us consider that a set I represents a set of traffic flows at a crossing. Each traffic flow $i \in I$ is characterized by intensity f_i , i.e. number of vehicles that enter the crossing per time unit, and the saturated intensity f_i^s of the flow, which is a maximum number of vehicles that can leave the crossing per time unit. Let τ_i be the standard for a minimum duration of green light for the flow i at the crossing.

Let $K = \{F_1, F_2, \dots, F_r\}$ be the set of r phases at the crossing. A phase F_k is a set of non-collision flows that can have simultaneously green light at the crossing. We assume that the phases follow in the order given by their indices and that the flow of green light period for all phases falls into the interval $(0, t_{max})$. Let m_{ij} be the minimal interval between two successive collision flows from different phases and let t_{max} be the time of crossing period duration.

The natural objective is to design a signal plan so that the total waiting time of all relevant participants is minimal. Let us realize what the waiting time is for a flow i with the intensities f_i and f_i^s , when duration of the red light is denoted as t_i^r and duration of the green light is denoted as t_i^g .

Figure 1 depicts the dependence of a number of waiting vehicles on the time during one period of a signal plan of a crossing. The shadow area in the figure corresponds with the total waiting time of all participants of the flow i entering the crossing during the period t_{max} .

* Jaroslav Janacek, Michal Kohani

Department of Transportation Networks, Faculty of Management and Informatics, University of Zilina, Slovakia,
E-mail: jaroslav.janacek@fri.uniza.sk,

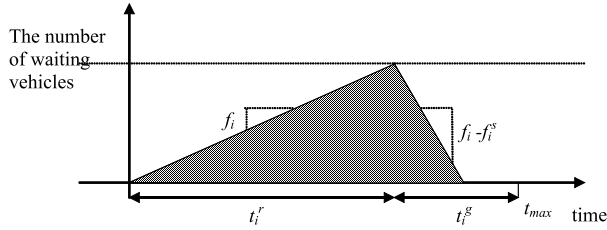

Fig. 1 The waiting time of the flow i during period t_{max}

The total waiting time of all participants of the flow i during the period t_{max} is:

$$0.5 * (t_i^r)^2 * f_i + 0.5 * (t_i^r)^2 * (f_i)^2 / (f_i^s - f_i) = 0.5 * (t_i^r)^2 * f_i^s / (f_i^s - f_i) \quad (1)$$

To build a model of the problem, we introduce the variable x_i as the starting time of the green signal of each traffic flow i during one period and the variable y_i as the ending time of the green signal of traffic flow i during one period. Due to simplification, we denote the value of expression (2) as c_i .

$$0.5 * f_i * f_i^s / (f_i^s - f_i). \quad (2)$$

To model the duration t_i^r of the red light, we introduce the auxiliary variable u_i , and then the model of the original problem can be stated as follows:

$$\text{Minimize } \sum_{i \in I} c_i * (u_i)^2 \quad (3)$$

$$\text{Subject to } t_{max} - y_i + x_i = u_i \text{ for } i \in I \quad (4)$$

$$y_i - x_i \geq \left(\frac{f_i t_{max}}{f_i^s} + 1 \right) \text{ for } i \in I \quad (5)$$

$$y_i - x_i \geq \tau_i \text{ for } i \in I \quad (6)$$

$$x_j - y_i \geq m_{ij} \text{ for } k = 1, \dots, r-1 \text{ } i \in F_k, j \in F_{k+1} \quad (7)$$

$$x_j - y_i \geq m_{ij} - t_{max} \text{ for } i \in F_r, j \in F_1 \quad (8)$$

$$x_i \in Z^+ \text{ for } i \in I \quad (9)$$

$$y_i \in Z^+ \text{ for } i \in I \quad (10)$$

$$u_i \geq 0 \text{ for } i \in I \quad (11)$$

The constraints (4) are link-up constraints connecting starting and ending times of the green light period with the associated length u_i of the red light period.

The constraints (5) assure that time of the green signal for the traffic flow i is at least as long as the crossing time for the passing of all incoming vehicles. The constraints (6) assure that time of the green signal for the traffic flow i is at least as long as the stan-

ard time (if the crossing time for the passing of all incoming vehicles is negligible).

Constraints (7) and (8) assure that the gap between the ending time and starting time of two collision traffic flows from two consecutive phases is greater or equal to the minimal interval between these two flows. Constraints (8) assure this situation for the traffic flows between the last and the first phase.

Unfortunately, the model (3)–(11) is non-linear because of the objective function (3). This constituted serious obstacle in the period, when the first attempt at the problem solving was done. That is why the non-linear problem was substituted by linear one. The substitution was in the following way [1]. The objective function corresponding with the total waiting time during the period t_{max} was abandoned and replaced by a demand that the minimal relative reserve of the relevant traffic flows should be as high as possible. The relative reserve of the flow i with time of the green signal t_i^g is defined by the ratio (12).

$$\frac{t_i^g}{\left(\frac{f_i t_{max}}{f_i^s} + 1 \right)} \quad (12)$$

To model this rearranged problem, we introduce a variable u as a lower bound on each relative reserve of all relevant flows. Now, making use of the above-mentioned variables x_i and y_i , the new problem can be described as follows.

$$\text{Minimize } u \quad (13)$$

$$\text{Subject to } y_i - x_i \geq u \left(\frac{f_i t_{max}}{f_i^s} + 1 \right) \text{ for } i \in I \quad (14)$$

$$y_i - x_i \geq \tau_i \text{ for } i \in I \quad (15)$$

$$x_j - y_i \geq m_{ij} \text{ for } k = 1, \dots, r-1 \text{ } i \in F_k, j \in F_{k+1} \quad (16)$$

$$x_j - y_i \geq m_{ij} - t_{max} \text{ for } i \in F_r, j \in F_1 \quad (17)$$

$$x_i \in Z^+ \text{ for } i \in I \quad (18)$$

$$y_i \in Z^+ \text{ for } i \in I \quad (19)$$

$$u_i \geq 0 \quad (20)$$

Assuming that $u \geq 1$, the constraints (14) assure that the time of the green signal for the traffic flow i is at least as large as the crossing time for the passing of all incoming vehicles. Relative reserve of the traffic flow i must be greater or equal to the lower bound u . The other constraints have the same meaning as constraints (6)–(8) respectively.

Comparing the two models, we have to admit that they are not equivalent, which implies that the result of the second problem solution need not optimize the original objective function. In the computational study we point out these differences and demonstrate their consequences.

3. Max-min approach to the arrival time coordination in public transport

Let us consider that a set I represents a set of n vehicle arrivals at an observed stop in a given period. Let t_i denote the time of the arrival i . This arrival time can be shifted from a time a_i , which denotes the earliest arrival time of the associated vehicle, to the time $a_i + c_i$, which denotes the last arrival of the vehicle. The period c_i is a maximal shift from the earliest arrival time of the vehicle.

Let t_0 be a fixed time of the first arrival and t_n be a fixed time of the last vehicle arrival. It is assumed that passengers come to the observed stop with an average intensity f . The objective is to move the times t_i for $i = 1, \dots, n-1$ so that the total waiting time of passengers is minimal.

Figure 2 depicts the dependence of waiting passengers on the time during the period $\langle t_0, t_n \rangle$. The shadow area in the figure corresponds with the total waiting time of all passengers visiting the stop during the considered period.

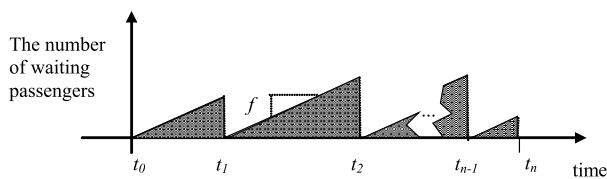

Fig. 2 The waiting time of passengers during period $\langle t_0, t_n \rangle$

It follows that the total waiting time of all considered passengers during the period $\langle t_0, t_n \rangle$ is:

$$\sum_{i=1}^n 0.5 * f * (t_i - t_{i-1})^2 \tag{21}$$

To simplify the following model, we introduce an auxiliary variable u_i as the maximal waiting time between the arrivals t_{i-1} and t_i for $i = 1, \dots, n$. We also introduce a variable x_i , for $i = 1, \dots, n-1$, which corresponds with a shift of the arrival time t_i versus time a_i . Then the model of this original problem can be stated as follows:

$$\text{Minimize } 0.5 * f * \sum_{i=1}^n (u_i)^2 \tag{22}$$

$$\text{Subject to } x_1 + a_1 - t_0 + u_1 \tag{23}$$

$$x_i + a_i - x_{i-1} - a_{i-1} = u_i \text{ for } i = 2, \dots, n-1 \tag{24}$$

$$t_n - x_{n-1} - a_{n-1} = u_n \tag{25}$$

$$x_i \leq c_i \text{ for } i = 1, \dots, n-1 \tag{26}$$

$$x_i \geq 0 \text{ for } i = 1, \dots, n-1 \tag{27}$$

$$u_i \geq 0 \text{ for } i = 1, \dots, n \tag{28}$$

Similarly as in the previous case of waiting time at the crossing also in this case [1] there was no smart tool at disposal to solve the quadratic problem (23)–(28). That was why the approach of maximization of the shortest period between consecutive arrivals was used. The variables x_i , for $i = 1, \dots, n-1$ were introduced as above and the variable y was used as the lower bound of periods between pairs of consecutive arrivals. Then, the following linear model was obtained:

$$\text{Minimize } y \tag{29}$$

$$\text{Subject to } x_1 + a_1 - t_0 \geq y \tag{30}$$

$$x_i + a_i - x_{i-1} - a_{i-1} \geq y \text{ for } i = 2, \dots, n-1 \tag{31}$$

$$t_n - x_{n-1} - a_{n-1} \geq y \tag{32}$$

$$x_i \leq c_i \text{ for } i = 1, \dots, n-1 \tag{33}$$

$$x_i \geq 0 \text{ for } i = 1, \dots, n-1 \tag{34}$$

$$y \geq 0 \tag{35}$$

Constraints (30), (31) and (32) assure that any time gap between arrival times of two consecutive arrivals must be greater or equal to the lower bound y . Constraints (33) assure that the time shift of the arrival time i is not greater than the maximal value of the shift for the arrival time.

4. Linearization of quadratic criteria

As mentioned before, the more precise original models with the waiting times expressions included into their objective functions had to be abandoned due to non-linearity even when the way of linearization had been known [2], [3]. The reason was that the linearized model after rearrangement becomes too large to be solved by the past tools.

In this paper we focus on answering the question whether the new techniques implemented in today's optimization tools are able to overcome the former obstacles. Further we will show the way of linearization, which can be used to replace objective functions (3) and (22) by linear expressions almost without loss of accuracy.

We have to realize several next properties of the processed non-linear models. First, both considered objective functions are separable. It means that each non-linearity included in summation depends only on one variable, whose value is bounded from lower and upper sides by the values 0 and u_i^{max} respectively. Second, the

objective functions are convex and their minimal value is searched for. Third, the time values in the transportation problems are given in some integer units, e.g. seconds or minutes. It means that one unit is a maximal accuracy, which is necessary to take into account. It follows that the quadratic function $(u_i)^2$ can be replaced by a piecewise linear function without loss of accuracy as shown in Figure 3.

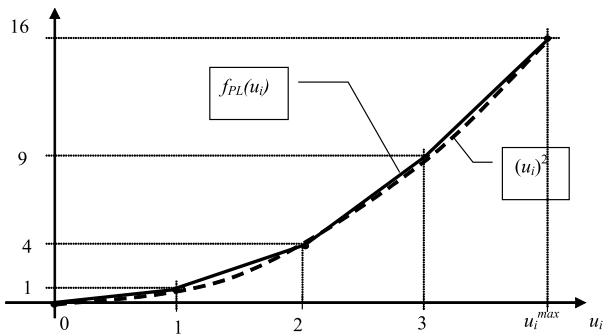

Fig. 3 The quadratic function and its approximation by a piecewise linear function $f_{PL}(u_i)$

To replace the non-linear item $(u_i)^2$ by a piecewise linear function in the range $\langle 0, u_i^{max} \rangle$, where u_i^{max} is integer, we introduce a set of auxiliary variables z_{ij} , where $0 \leq z_{ij} \leq 1$ for $j = 1, \dots, u_i^{max}$. Then, the relation between variables u_i and z_{ij} can be expressed by equation (36).

$$u_i = \sum_{j=1}^{u_i^{max}} z_{ij} \tag{36}$$

The non-linear item $(u_i)^2$ can be replaced by the right-hand-side of equation (37).

$$(u_i)^2 = \sum_{j=1}^{u_i^{max}} (2 * j - 1) z_{ij} \tag{37}$$

In a common case when this way of linearization is used it is necessary to assume that $z_{ij+1} = 0$ follows from $z_{ij} < 1$. Nevertheless, the assumption of convexity of the minimized objective function approves this implication.

Now, models (2)-(11) and (22)-(28) can be linearized by introducing a series of variables $z_{ij} \geq 0, j = 1, \dots, u_i^{max}$ for each non-linearity $(u_i)^2$. The quadratic items in the objective function must be replaced by a linear expression according to equation (37) and link-up constraint (36) must be added to the model for each u_i . Furthermore, each model must be enlarged by constraints (38).

$$z_{ij} \leq 1 \text{ for } i \in I, j = 1, \dots, u_i^{max} \tag{38}$$

This way, the models become linear and linear-programming solvers programmers can solve the associated problems. Nevertheless, we have to note that the number of auxiliary variables z_{ij} can be a considerably large number in some cases. The number is equal to the value of expression (39).

$$\sum_{i=1}^n u_i^{max} \tag{39}$$

5. Case study by XPRESS-IVE

To perform the computation of the original problems with the waiting time and also the derived max-min problems, we used the general optimization software environment XPRESS-IVE for our study [4], [5]. This software system includes the branch-and-cut method and also enables solution of large linear programming problems. The software is equipped with the programming language *Mosel*, which can be used for both the input of a model and writing of input and output procedures. The experiments were performed on a personal computer equipped with Intel Core 2 Duo E6850 with parameters 3 GHz and 3.5 GB RAM.

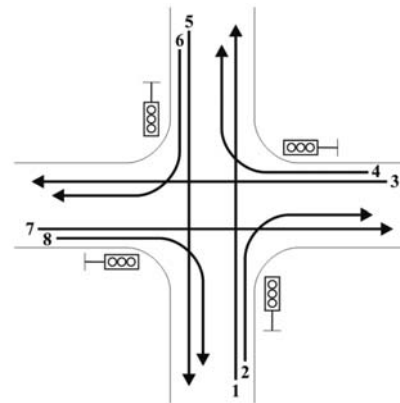

Fig. 4 Signal plan example

To verify the method we formulated an instance for each problem. The instance of a signal-plan determination for a light-controlled crossing problem consists of 8 traffic flows which are divided into two phases. The first phase consists of flows 1, 2, 5 and 6, and the second phase consists of flows 3, 4, 7 and 8. The situation with traffic flows is described in Fig. 4. The values of

Signal plan example - f_i, f_i^s, τ_i Table 1

i	f_i	f_i^s	τ_i [s]	F_1	F_2
1	0.1	0.3	10	1	
2	0.2	0.5	10	1	
3	0.15	0.4	10		1
4	0.2	0.6	10		1
5	0.1	0.3	10	1	
6	0.15	0.35	10	1	
7	0.25	0.6	10		1
8	0.15	0.4	10		1

flow intensities f_i , saturated flow intensities f_i^s , standard minimum duration τ_i of the green light for the flow i and assignment of flows to phases are reported in Table 1. Table 2 contains the values of the minimal time period m_{ij} between two successive collision flows from different phases. The value of time of the crossing period t_{max} was set to 150 seconds.

Signal plan example - m_{ij} Table 2

m_{ij}	1	2	3	4	5	6	7	8
1	-	-	8	8	-	-	8	-
2	-	-	-	-	-	-	10	-
3	8	-	-	-	8	8	-	-
4	10	-	-	-	-	-	-	-
5	-	-	8	-	-	-	8	8
6	-	-	10	-	-	-	-	-
7	8	8	-	-	8	-	-	-
8	-	-	-	-	10	-	-	-

Results obtained by software environment XPRESS-IVE are presented in Table 3. The column "Max-min" contains resulting lengths of the green signal for flow i obtained by max-min approach (13)-(20) and the column "Quadratic" contains the lengths of the green signal for flow i obtained by the linearization of quadratic criteria (2)-(11),(37),(38). "Waiting time" denotes the value of the total waiting time in vehicle-seconds, "Row" denotes the number of structural constraints of the model and "Columns" denotes the number of used variables. The computational time in both cases

Solutions for signal plan example obtained by max-min approach and linearized quadratic criteria Table 3

i	Max-min	Quadratic
	$y_i - x_i$	$y_i - x_i$
1	60	51
2	65	61
3	61	63
4	55	81
5	65	51
6	70	66
7	68	74
8	62	81
Rows	48	56
Columns	17	1216
Waiting Time	698 [vs]	573 [vs]

The instance of the arrival time coordination problem consists of 8 vehicle arrivals which can be shifted. The description of the instance and the associated solution are given in Fig. 5 and Table 4. The column a_i denotes the earliest possible arrival time of an associated vehicle, c_i denotes the maximal shift of arrival of

the vehicle. We used the value of 10 for the intensity f of the passengers coming to the stop.

The column "Max-min" contains resulting lengths of intervals between two successive arrivals obtained by the max-min approach (29)-(35). The column denoted as "Quadratic" contains the lengths obtained by the second method. "Waiting time" denotes the value of the total waiting time in person-seconds, "Rows" denotes the number of structural constraints of the model and "Columns" denotes the number of used variables. The computational time in both cases was also less than 1 second.

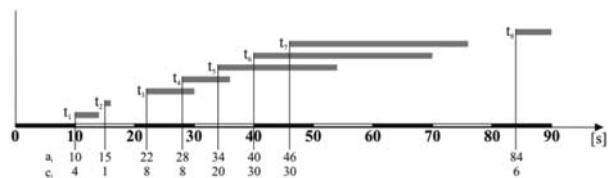

Fig. 5 Instance of the arrival time coordination problem

Solutions obtained using max-min approach and linearized quadratic criteria Table 4

i	a_i	c_i	Max-min	Quadratic
			$t_i - t_{i-1}$	$t_i - t_{i-1}$
0	0	0	-	-
1	10	4	10	10
2	15	1	6	6
3	22	8	6	10
4	28	8	6	10
5	34	20	6	12
6	40	30	6	12
7	46	30	6	12
8	84	6	38	12
9	90	0	6	6
Rows			17	25
Columns			9	359
Waiting Time			16760 [ps]	9480 [ps]

6. Conclusions

We renewed a solving approach to the public transport problems which originally included the waiting time in their objectives; nevertheless they had been solved by much simpler max-min method. Our contribution to the problem solving consists in complying with the original non-linear objective function which expresses the time lost by waiting passengers. To solve the problems with the original objective function, we applied a piecewise linear approximation of the quadratic items and made use of special properties of optimization environment XPRESS-IVE to solve the resulting large linear problems. We implemented both former and latter method to be able to compare the resulting

optimal solutions, the sizes of processed models and the computational times necessary for obtaining optimal solutions. We found that even if piecewise linear models are much larger than the previously used max-min models, the computational times increased negligibly. With regard to the quality of optimal solutions, the comparison shows that the solutions obtained by the renewed approach are much better than those obtained by the former max-min approach.

Acknowledgement:

This contribution is the result of the project implementation: Centre of excellence for systems and services of intelligent transport, ITMS 26220120028 supported by the Research & Development Operational Programme funded by the ERDF.



Agentúra
Ministerstva školstva, vedy, výskumu a športu SR
pre štrukturálne fondy EÚ

"Podporujeme výskumne aktivity na Slovensku/Projekt je spolufinancovaný zo zdrojov EÚ."

References

- [1] CERNY, J., KLUVANEK, P.: *Bases of Mathematical Theory of Transport*. VEDA : Bratislava, 1991 (in Slovak).
- [2] KORBUT, A. A., FINKELSTEIN, J.J.: *Discrete Programming*. ALFA : Bratislava, 1972, 359 p. (in Slovak).
- [3] WILLIAMS, M. P.: *Model Solving in Mathematical Programming*. John Wiley&Sons : Chichester, p. 359.
- [4] XPRESS-MP Manual "Getting Started". Dash Associates, Blisworth, UK, 2005, p. 105.
- [5] XPRESS-Mosel "User guide". Dash Associates, Blisworth, 2005, UK, p. 99.

DYNAMIC ARCHITECTURE FOR ANALYTICAL ITS SERVICES

The emergence of various technologies allowing the real-time collection, processing and transfer of data between stationary traffic devices, moving vehicles and data centers provides many new possibilities for Intelligent Transportation Systems (ITS). However, the need for mobile access to analytical data leads to problems with mobile computers connectivity. Mobile computers often suffer from limited connectivity or lack of network access. Existing data replication solutions are not well suited for mobile scenarios as well as algorithms used for data replication, in spite of the fact that it is the most desirable environment. In the following paper we introduce the algorithm for analytical data replication forming dynamic architecture including mobile computers connected by wireless network based on IEEE 802.11.

Keywords: Intelligent transportation systems, distributed database systems, data replication, mobile networks, vehicular networks

1. Introduction

The emergence of various technologies allowing the real-time collection, processing and transfer of data between stationary traffic devices, moving vehicles and data centers provides many new possibilities for Intelligent Transportation Systems (ITS). Vehicular networks (VANETs), as a subset of Mobile Ad-Hoc Networks (MANETs) are gaining importance because they allow local data exchange and limited internet access for vehicles moving together in a traffic flow. The vehicles which are outside the range of a stationary communication gateway can be still connected through nearby vehicles.

These networks have however very specific characteristics mainly due to the fact that the mobile elements (vehicles) are moving at high speeds, which has considerable impact on the performance of functions like connection initiation, addressing, routing, etc. On the other hand, mobile nodes could provide similar communication services as stationary nodes. The basic problem is to decide when a mobile node could be included in a communication model as a stationary node and when as regular mobile node – a client. Considering a distributed data delivery system or distributed databases system, we need to create a replication model in which mobile nodes could be included in a replication schema.

2. Problem definition

Distributed database systems and distributed database management systems have been developed in response to trend of distributed computation. In distributed models of computations several sites are connected via a communications network. However, the need for mobile access to large databases leads to problems with mobile computer connectivity. Mobile computers often suffer from

limited connectivity or complete lack of network access. Existing replicated databases are not well suited for mobile scenarios as well as algorithms used for data replication, in spite of the fact that it is the most desirable environment.

A basic problem comes with the assumption that the single network can not satisfy communication needs. This is typical for mobile communication networks used for personal communication as well as wide area communication networks. For our architecture we can consider a virtual wide area network characterized by common communication network parameters such as bandwidth, latency and others. Nevertheless, communication parameters must be continuously re-evaluated since the geospatial network is much more sensitive to communication parameters changes than commonly used local area networks.

Another principal problem is typical for mobile networks. The communication network consists of static and mobile nodes. Hence we need to take into consideration two kinds of characteristics for nodes and communication network (vertices and edges in graph representation). In principle, static and mobile nodes need each different management by the architecture itself.

Since a virtual network allows us to serve fundamental needs for huge information based services such as analytical information distribution, we will use the static model for basic data distribution across a network. The replication itself provides mechanism for data distribution to that part of network where the information portion is consumed. Hence, data replication benefits follow our needs for analytical data distribution.

In general, wireless communication networks keep track of a mobile client's location through a profile. This profile contains not only client's current position (or location) but also another

* Michal Zabovsky, Matus Chochlik, Karol Matiasko, Eva Valentikova

Department of Informatics, Faculty of Management Science and Informatics, University of Zilina, Slovakia,
E-mail: michal.zabovsky@fri.uniza.sk

information used for billing and authentication [1]. We recommend using profiles for application and services implemented in ITS. Since the connectivity, bandwidth, data storage and processing capacity of the individual elements in ITS's virtual architecture varies in time, the system must also handle the load balancing and prioritization of the distributed information [2].

For the fragment allocation problem the assumption comes with WAN described as a network. The network consists of sites $S = \{S_1, S_2, \dots, S_m\}$, on which a set of transactions $T = \{T_1, T_2, \dots, T_q\}$ is running and a set of fragments $F = \{F_1, F_2, \dots, F_n\}$ into which global data can be distributed [3]. This is the generalized problem and it could be adopted for more specific purposes focusing the optimal data distribution.

The principal problem of distribution follows two definitions of optimality: minimal cost and maximal performance. The cost function consists of the cost of storing each F_j on site S_k . Existing models and implementations are mostly based on a read/write pattern for the first definition of optimality or response time/throughput at each site for the second one. Both optimizations can be performed either statically or dynamically.

Static optimization solves the problem of partitioning all global relations during the fragmentation phase of distributed database design [4]. Adaptive optimization tries to make suboptimal solution by using some kind of heuristic algorithm taking in consideration runtime behavioral statistics of a distributed database [5] [6]. Alternative methods are discussed e.g. in [7].

3. Model for client-based ITS services

Considering advanced services provided by ITS, we need to take into account significant data portions transported by a communication network. Since for low data consuming services common GSM networks can be used, this kind of network is inappropriate for large data transmissions. Of course, advanced communication protocols could be used e.g. HSDPA, but the question of low cost independent solution is still relevant.

A basic model for adaptive data replication including mobile nodes connected via IEEE 802.11 standards was introduced in [8] [9]. By the static fragment allocation the fragments are located at the sites from which they are most frequently accessed. Since the distributed database system is rather dynamic, the main problem with previous, static allocation of fragments comes with changing workload. This occurs when the access frequencies to various portions of database from a particular site vary with time. Even very simple methods for dynamic data allocations are able to improve the system throughput by 30 percent. Experimental evaluation of dynamic data allocation strategies can be found in [10]. To determine when a re-allocation is needed, algorithms proposed in [10] maintain weighted counters of the number of access from each site to each block. For effective estimation the aging factor is used to update counters. The main problem can be divided into the two problems: how to detect changes in workload and how to dynam-

ically re-allocate fragments of database result in improved throughput.

Considering mobile nodes, the communication network characteristics must be evaluated carefully since they form a transmission cost matrix. Basic characteristics for static nodes, such a throughput and latency (or round-trip time), can be estimated reliably by tools such a *tstat* or *pathchar*. For wireless clients is estimation more difficult. Technology for wireless communication based on the IEEE 802.11 standards provides connection with variable transmission characteristics. Rather than throughput and latency a *signal-to-noise ratio* (SNR) is a characteristic that has to be involved in a replication model. SNR affects both characteristics throughput and latency in a significant way as shown in [11]. SNR directly impacts the performance of a wireless connection. A higher SNR value (in dB) means that the signal strength is stronger in relation to the noise levels, which allows higher data rates and fewer retransmissions.

The linear mathematical model for throughput prediction based on previous observations can be defined as [11]:

$$T = T_{max} \quad SNR > SNR_C \quad (1)$$

$$T = A \times (SNR - T_0) \quad SNR \leq SNR_C \quad (2)$$

Where T_{max} is a saturation throughput, A defines slope, T_0 is a breaking point where T_{max} is changing to curve described by A , SNR_0 is a cutoff SNR specified by a hardware vendor and SNR_C defines a critical threshold. A respective exponential model is also described in [11], for the proposed solution linear algorithm is sufficient enough to describe communication network characteristics. Now we can define a set SNR_C of m elements, where each value snr_{ci} represents the critical threshold for site i as $SNR_C = \{snr_{c1}, snr_{c2}, \dots, snr_{cm}\}$. When the site i is a static node, the critical threshold is zero. Finally, we need to implement a function which returns the current SNR value for mobile nodes. Such a function is necessary to implement on each site from the replication schema since it depends on a particular configuration.

4. Adaptive algorithm

Based on previous observations, we defined the adaptive replication algorithm [8] which manages mobile node access into the replication schema. For ITS architecture the main modification is based on an assumption that mobile nodes are using analytical data only for reading. Since we can spread the replication schema by this algorithm, it is increasing availability of large data set to be replicated on mobile nodes. By experimental evaluation we simulated transfer of fragments inside the replication schema by using the algorithm without and with mobility management.

The modified algorithm for analytical data distribution in ITS architecture has in comparison with the algorithm proposed in [8] only one phase. The expansion test is used for spreading data over mobile nodes. The second test, test of contraction, is not used

since we are managing to write operations only on static nodes. The replication schema in this architecture is not necessarily associated with the database but the data distribution itself.

Test of expansion:

- Step 1: The control process examines read counters for each fragment containing analytical data.
- Step 2: The site with the highest counter value is marked as a candidate for fragment re-allocation.
- Step 3: If the candidate is the site on which the fragment is currently located, go to step 6.
- Step 4: For the mobile nodes get SNR and SNR_c values. For static nodes return $SNR = 100$ and $SNR_c = 0$.
- Step 5: If $SNR > SNR_c$ then copy the fragment from the original site to the candidate site. Otherwise choose the site with the highest counter value from the set of unmarked sites and mark it as a candidate for fragment re-allocation - then go to step 3.
- Step 6: Wait for a specified number of transactions to be completed and then go to step 1.

The experimental results show that for regular connection when a mobile is not suffering from a limited access the number of transactions per second (TPS) stays on the same level. TPS is one of the most common benchmark criteria, thus we present the replication performance in this value. For mobile nodes with variable

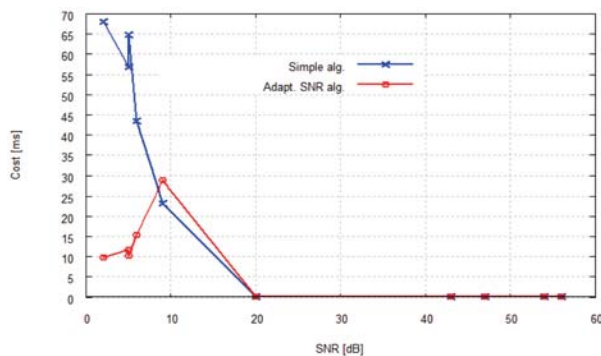

Fig. 1 Adaptive replication algorithm - replication cost

SNR the situation is much more interesting. The adaptive algorithm shows a significantly better TPS number and this gain from implementation can be used for a better mobility management. By SNR checking we can easily improve the overall performance and select mobile nodes for analytical (and thus large) data transmission.

The overall replication cost is reduced mostly for an unstable communication network as shown in Figure 1. Local maximum is presented about the critical SNR (SNR_c). It means that at this point even our algorithm is not able to improve the performance significantly due to the variability of communication network characteristics. For bad network parameters, on the other hand, the introduced algorithm is significantly better than a non-managed replication. The observed results show about 60 percent better overall response time. This is given by the fact that the proposed algorithm avoids the replica transmission to the node with communication problems. Hence the unwilling transmission is not causing problem of Nash equilibrium in the communication network [12].

5. Conclusion and future work

Performance in distributed database systems is heavily dependent on allocation of data among the sites of a replication schema. The static allocation provides only a limited response to workload changes. The situation is even worse when mobile nodes are included in the replication schema. We presented the algorithm for dynamic re-allocation of data with mobile computers included in the replication schema. The proposed algorithm offers a significantly increased performance for nomadic nodes with a limited connection. Our experiments make a practical case for future development of algorithms for changing environment such as intelligent transportation systems, location aware application and information systems for mobile users.

Acknowledgement:

This contribution is the result of the project implementation: Centre of excellence for systems and services of intelligent transport, ITMS 26220120028 supported by the Research & Development Operational Programme funded by the ERDF.



"Podporujeme vyzkumne aktivity na Slovensku/Projekt je spolufinancovany zo zdrojov EU."

References:

- [1] TIAN, K. Q., COX, D. C.: *Mobility Management in Wireless Networks : Data Replication Strategies and Applications*. Kluwer Academic Publishers, 2004.
- [2] MARTINCOVA, P., GRONDZAK, K.: Effective distributed query processing on the grid. In: *2nd International Workshop on Grid Computing for Complex Problems - GCCP 2006*, Bratislava, 2006, pp. 129-135.
- [3] HUANG, Y-F., CHEN, J-H.: Fragment Allocation in Distributed Database Design. *Journal of Information Science and Engineering*, No. 17, pp. 491-509, 2001.
- [4] JANACEK J.: *Mathematical programming [Matematicke programovani]*. Zilina : EDIS-ZU, 1999 (in Czech).
- [5] WOLFSON, O., JAJODIA, S., HUANG, Y.: An Adaptive Data Replication Algorithm. *ACM Transactions on Database Systems (TODS)*, Vol. 22, No. 2, pp. 255-314, 1997.
- [6] GRONDZAK, K. et al.: Distributed Solving of combinatorial problems. In *2nd International Workshop on Grid Computing for Complex Problems - GCCP 2006*, Bratislava, 2006, pp. 82-87.
- [7] ARTHUR, L., CORCORAN, HALE, J.: A Genetic Algorithm for Fragment Allocation in a Distributed Database System. In: *Proc. of the 1994 ACM symposium on Applied computing*, Phoenix, Arizona, United States, 1994, pp. 247-250.
- [8] MATIASKO, K., ZABOVSKY, M.: Adaptive Replication Algorithm for Mobile Computers. *Acta Electronica et Informatica*, Vol. 8, No. 2, pp. 18-21, 2008.
- [9] MATIASKO, K., ZABOVSKY, M.: A Data Replication for Mobile Environment. *J. of Electrical Engineering*, Vol. 59, No. 5, pp. 277-280, 2008.
- [10] BRUNSTROM, A., LEUTENEGGER, S. T., SIMHA, R.: *Experimental Evaluation of Dynamic Data Allocation Strategies in a Distributed Database with Changing Workload*. Institute for Computer Applications in Science and Engineering (ICASE), Technical Report TR-95-2, 1995.
- [11] CHEN N., CHEN, J. K., RAPPAPORT, TH. S.: Measured Traffic Statistics and Throughput of IEEE 802.11b Public WLAN Hotspots with Three Different Applications, *IEEE Transactions on Wireless Communications*, Vol. 5, No. 11, pp. 3296-3305, 2006.
- [12] ALMENDRAL, J. A., LUIZ, L., VINCENT, CH., SANJUAN, M. A. F.: Congestion Schemes and Nash Equilibrium in Complex Networks. *Physica A*, No. 355, pp. 602-618, 2005.

Miroslav Gabor *

PROPOSAL FOR THE SIZE OF THE FLEET TO PROVIDE WINTER ROAD MAINTENANCE

The article describes an optimisation model which was used to create the operation plan of winter road maintenance [6]. The model takes into consideration a number of factors of road description, such as road network topology, road categories and level of services. They result in suggesting the necessary number of vehicles the centres of winter road maintenance should have to be able to keep, the servicing time limit given by the operation plan in case of a calamity. The model also proposes what the most optimal vehicle routing would be timewise.

Key words: winter road maintenance, road gritting, vehicle routing problem, fleet sizing

1. Introduction

Performing winter road maintenance (WRM) is an important activity, necessary to keep the traffic on our roads in winter period safe and smooth. The appropriate authorities at all levels supposed to make sure roads are passable are the nation-wide authorities that administer the roads of the categories II and III, and the municipal authorities that are in charge of the roads and walkways in municipalities. Yearly, they all spend not a little money on the job. The finance they have to spend is not unlimited, of course, and the companies carrying out WRM often face the problem of having winter road maintenance machinery that is not functioning properly. This sometimes means the companies are not able to react to calamities sufficiently enough, which might result in dangerous traffic situations.

When WRM is well planned and organized, it is possible to achieve remarkable cost and energy savings, and at the same time to keep or even improve the operation level and quality of WRM.

2. Problem formulation

Let us have a road network consisting of individual road segments. The road network is divided into several regions. In the network there are fixed maintenance centres. Each of them has a given number of available winter maintenance vehicles (gritting vehicles, ploughs), as well as a given number of sufficiently dimensioned gritting material depots.

The WRM operation plan may be formally defined as follows: after a calamity emergency has been announced, the road network

needs to become passable within a given time limit. The road categories determine the maintenance priority. Vehicle routings need to be planned and synchronized, so that the given time limit can be kept. The individual routings are represented by a sequenced list of road segments. The starting and finishing points of the list are identical – the maintenance centre. The routings do not need to be planned to be mutually excluding, which means some of the road segments can be part of several routings. Thus the routings of individual vehicles consist of two types of road segments: those the vehicle does WRM on, and those the vehicle just uses for transit.

The goal of the solution is to propose the minimal number of WRM vehicles necessary to keep the operation plan time limit. The proposal does not deal with changing the locations of the winter maintenance centres and gritting material depots, or with changing the road segments allocation to the individual regions.

3. Proposed solution

We are going to describe the road network of one region as a connected oriented graph $G = (V, E)$, where $G = \{v_1, v_2, \dots, v_n\}$ is a vertex set and $E = \{(v_i, v_j) : v_i, v_j \in V, i \neq j\}$ is an edge set. With every edge (v_i, v_j) is associated a non-zero length $c_{i,j}$. Let $sc_{i,j}$ be the length of the shortest path connecting the vertex v_i with the vertex v_j in the graph G . Let $D \subset V$ be a set of the centres, each of them with a given number of vehicles.

The analysis of the problem has determined the type of the task to be solved: it is a modification of *CPP (Chinese postman problem)*. The modification is a result of the gritting vehicles capacity limitation, which leads to *CCPP (Capacitated Chinese postman problem)*,

* Miroslav Gabor

Department of Software Technologies, Faculty of Management Science and Informatics, University of Zilina, Slovakia,
E-mail: miroslav.gabor@fri.uniza.sk

as well as of the fact that not all of the edges require to be attended, which leads to *RPP (Rural postman problem)* [2].

The modifications named above make the task NP-difficult. That is why it was suggested to use a heuristic approach to solve the task. The approach is based on the primary Clark-Wright heuristic method [1] modified to attend the edges in the oriented graph. The method is further modified in dependence on the number of additional and limiting conditions [3].

The routings of individual gritting vehicles are calculated independently for each of the regions. We might describe the solution method in a simplified way as follows:

1. Selecting a random not gritted edge (v_i, v_j) with the highest priority; we will call it the primary edge.
2. Allocating the primary edge (v_i, v_j) to the nearest centre $v_d \in D$ with a gritting vehicle available.
3. Transferring the gritting vehicle from the centre $v_d \in D$ to the primary edge (v_i, v_j) using the shortest path.
4. Gritting the primary edge and transferring to the centre, using the shortest path. The primary routing $[v_d, \dots, v_i, v_j, \dots, v_d]$ has originated.
5. Selecting a not gritted edge (v_k, v_l) with the highest priority, the one closest to the primary edge.
6. Gritting the edge (v_k, v_l) and inserting it into the routing $[v_d, \dots, v_i, v_j, \dots, v_k, v_l, \dots, v_d]$.
7. If the routing takes less time than the time limit is, returning to the point 5. Otherwise as follows:
8. Closing the routing.
9. If there is a not gritted edge remaining, returning to the point 1. Otherwise as follows:
10. Saving the solution and returning to the point 1. Repeating the steps n-times.
11. Selecting the best solution which is the one than requires the lowest number of vehicles within the region, and the sum of the routing times of all vehicles is minimal.
12. The end of calculation within one region.

4. Processing the documentation and creating the input data

An important, and often also a much time consuming part of solving the task was to prepare the input data of good quality for

the calculations [3]. We used the road network of Zilina self-governing region divided into five regions as the source of the input data for the solution. When transforming the road network into the graph, we identified the road segments from the map documentation as the graph edges, and they were allocated with the starting and ending nodes. The total number of the road segments is 727, each of them is a two-way, which means the number of the edges in the graphs equals 1454. Table 4.1 shows the number of edges for the individual regions.

Number of edges in the individual regions Table 4.1

Region	Number of edges	Number of centres	Number of vehicles
Horne Povazie	326	5	21
Liptov	344	4	21
Turiec	310	2	15
Orava	270	3	25
Kysuce	204	4	14

Except the length there are more data defined for each of the edges:

- Routing - it is supposed to differentiate the roads of various width arrangements and ways of maintenance. It distinguishes two and more lane two-way roads with only one lane to be gritted in each direction, one-way roads with one lane to be gritted, four and more lane two-way roads where two vehicles move simultaneously in each of the directions during the maintenance, two and more lane one-way roads where two vehicles move simultaneously in one direction.
- Priority - a numerical entry which distinguishes the importance of the individual road segments transportation-wise; it depends on the category which the road the segment is a part of falls into.
- Demandingness - it takes into consideration the consumption of gritting material according to the type and complexity of a road segment. From the viewpoint of their demandingness segments are divided into critical (very dangerous), to be gritted with the dosage of 300g/m² of mixed gritting material, dangerous with the dosage of 150g/m², others with the dosage of 80g/m², and not maintained segments.

Entries characterizing the edges

Table 4.2

Road number	Start. node	End. node	Length	Routing	Priority	Dem. ness	Gritting speed	Transit speed	Name of the edge
II / 520	4-10	4-31	7000	1	2	3	40	50	KRASNO NAD K - KLUBINA
II / 520	4-31	4-32	3800	1	2	3	40	50	KLUBINA - RADOSTKA, connection
II / 520	4-32	4-33	5130	1	2	3	40	50	RADOSTKA, connection - NOV BYSTRICA
II / 520	4-77	5-118	6500	1	3	5	25	25	water reservoir BYSTRICA - ORAV LESNA, west
III / 520003	4-32	4-53	2738	1	1	0	40	50	RADOSTKA, connection - ST BYSTRICA
III / 520001	4-32	4-87	3600	1	1	0	40	50	RADOSTKA, connection - RADOSTKA 1
III / 520001	4-87	1-130	396	1	2	1	30	30	RADOSTKA 1 - RADOSTKA

- Gritting speed of the vehicle – it takes into consideration how much the demandingness of a segment enables the vehicle to move. For critical segments, the speed was to 25 kms/hr, for dangerous segments it is 30kms/hr, and for other segments it is 40 kms/hr.
- Transit speed of the vehicle – it takes into consideration how much the demandingness of a segment enables the vehicle to move. The speed values for critical and dangerous segments are identical with the gritting speeds, the transit speed for flat segments is set to 50kms/hr.
- Number of the road – it helps identify a given segment.
- Name – identification entry (text description of an edge) which makes it possible to identify the exact position of a segment on a road map.

Vertex of the graph represent the vehicle centres, and they are allocated with the existing numbers of vehicles. Table 4.3 is an example for the region of Kysuce.

Numbers of vehicles in the region of Kysuce Table 4.3

Centre	Number of gritting vehicles
Kysucke Nove Mesto	5
Makov	5
Stara Bystrica	2
Podvysoká	2

5. Assessing the current situation and proposing the required number of vehicles

We did calculations for the input entries above, and processed several of their outputs into tables. They provide an overview of numbers of gritting vehicles in the regions (Table 5.1) and in the

Proposed number of vehicles for the individual regions Table 5.1

Region	Current situation	Proposal	Surplus	Shortage
Horne Povazie	21	21	-	-
Liptov	21	26	-	5
Turiec	15	15	-	-
Orava	25	23	2	-
Kysuce	14	16	-	2

Proposed number of vehicles for the centres of the region of Kysuce Table 5.2

Region	Current situation	Proposal	Surplus	Shortage
Kysucke N. Mesto	5	8	-	3
Makov	5	6	-	1
Stara Bystrica	2	2	-	-
Podvysoka	2	0	2	-
SPOLU	14	16	2	4

Gritting vehicle routing

Table 5.3

Centre: <i>Stara Bystrica</i> , routing 1. Time of routing: 118.69 minutes, length of routing: 68.01 kms					
Seq. number	Road number	Starting vertex	Ending vertex	Action	Name of edge
1.	III / 520003	4-53	4-32	gritting	ST BYSTRICA - RADOSTKA , connection
2.	II / 520	4-32	4-33	gritting	RADOSTKA, connection - NOV BYSTRICA
3.	II / 520	4-33	4-34	gritting	NOV BYSTRICA - VYCHYLOVKA, connection
4.	II / 520	4-34	4-35	gritting	VYCHYLOVKA, connection - NOV BYSTRICA, east
5.	II / 520	4-35	4-77	gritting	NOV BYSTRICA, east - water reservoir BYSTRICA
6.	II / 520	4-77	5-118	gritting	nadrz BYSTRICA - ORAV LESNÁ, west
7.	II / 520	5-118	4-77	gritting	ORAV LESNA, west - water reservoir BYSTRICA
8.	II / 520	4-77	4-35	gritting	water reservoir BYSTRICA - NOV BYSTRICA, east
9.	II / 520	4-35	4-34	gritting	NOV BYSTRICA, east - VYCHYLOVKA, connection
10.	II / 520	4-34	4-33	gritting	VYCHYLOVKA, connection - NOV BYSTRICA
11.	II / 520	4-33	4-32	gritting	NOV BYSTRICA - RADOSTKA, connection
12.	III / 520003	4-32	4-53	gritting	RADOSTKA, connection - ST BYSTRICA
13.				loading	
14.	III / 520003	4-53	4-32	transit	ST BYSTRICA - RADOSTKA , connection
15.	II / 520	4-32	4-31	gritting	RADOSTKA, connection - KLUBINA
16.	II / 520	4-31	4-10	gritting	KLUBINA - KRASNO NAD K
17.	II / 520	4-10	4-31	gritting	KRASNO NAD K - KLUBINA
18.	II / 520	4-31	4-32	gritting	KLUBINA - RADOSTKA, connection
19.	III / 520003	4-32	4-53	transit	RADOSTKA, connection - ST BYSTRICA

individual centres (Table 5.2) that are necessary to keep the given 120-minute time period for WRM.

Apart from proposing the number of vehicles, we designed a routing for each vehicle, defined by the sequence of the edges and with the information whether the given edge is supposed to be gritted or just transited without gritting. There is an example in Table 5.3 with a routing proposed for one of the vehicles of the centre Stara Bystrica in the region of Kysuce.

6. Conclusion

The proposed solution suggests such numbers of vehicles that are able to carry out WRM in the required quality. We suggested routings for WRM vehicles for the time limits set for carrying out WRM.

To a great extent, the results are influenced by the values of the input data – gritting material consumption, WRM vehicles speed

when gritting the road segments and when transiting the road segments that do not require to be gritted. Last but not least the results are also influenced by the division of the road segments into critical (very dangerous), dangerous and others. Specifying them will increase the reliability of the calculations.

Also the number of simplifications of the suggested solution has an impact on the accuracy of the results. Moreover, it is possible to improve the proposed heuristic, too, and more research is being done into the possibility to combine proposed routings within one centre, re-calculate them and look for potential improvements.

Acknowledgement:

This contribution is the result of the project implementation: Centre of excellence for systems and services of intelligent transport, ITMS 26220120028 supported by the Research & Development Operational Programme funded by the ERDF.



Agentúra
Ministerstva školstva, vedy, výskumu a športu SR
pre štrukturálne fondy EÚ

"Podporujeme vskumne aktivity na Slovensku/Projekt je spolufinancovany zo zdrojov EU."

References

- [1] JANACEK, J.: *Optimization in Transport Networks (in Czech)*, EDIS-ZU, Zilinska univerzita : Zilina, 2003, p. 248.
- [2] PALUCH, S., PESKO, S.: *Quantitative Methods in Logistics, Monograph*, EDIS-ZU, Zilinska univerzita : Zilina, 2007, 185 p., ISBN 80-8070-636-0.
- [3] VALUCH, M., GABOR, M., TROJANOVA, M., PAZUR, P.: *Winter Road Maintenance Operations for 2nd and 3rd Class Roads in Self-governing Region Agency (in Slovak)*, 11th International Conference Q-2009, 2009, Zilina : Krupa print, pp. 220–225, ISBN 978-80-970139-0-5.
- [4] PERRIER N, LANGEVIN A, CAMPBELL J. F.: A Survey of Models and Algorithms for Winter Road Maintenance. Part III: Vehicle Routing and Depot Location for Spreading, In: *Computers & Operations Research*, 2004.
- [5] PERRIER N, LANGEVIN A, CAMPBELL J. F.: A Survey of Models and Algorithms for Winter Road Maintenance. Part IV: Vehicle Routing and Fleet Sizing for Plowing and Snow Disposal, In: *Computers & Operations Research*, 2004.
- [6] *Winter Road Maintenance Operational Plan of Zilina Self-governing Region (in Slovak)*, winter season 2009/2010, Zilina self-governing region Road Administration, 2009.

DISTRIBUTED DATABASE SYSTEMS IN VEHICULAR AD-HOC NETWORK

The article introduces basics of classic Distributed Database System (DDBS) and explains its unsuitability for dynamically changing networks such as Vehicular Ad-hoc Network (VANET). Thus a concept of a new architecture is proposed. This new architecture is designed for use in mobile networks as it solves problems of classic architecture, however as explained at the end of the article, it has some limitations of its own.

Introduction

Vehicular Ad-hoc Network (VANET) is a form of Mobile Ad-hoc Network (MANET) which interconnects vehicles among themselves and vehicles with nearby roadside equipment. The main goal of VANET is to provide safety and comfort for passengers. Typically, vehicles are moving rapidly in large geographic areas. Equipped with wireless network devices they would have direct network access only to several other nodes in close distance. Furthermore connection to some of them would be lost in a short time but others would become available.

In such an environment plenty of new data are produced every moment however they are to be obsolete by even newer data soon. In certain applications these data could become useful if they were accessible and aggregated in a proper moment. This leads to the idea of Distributed Database System (DDBS) in VANET.

A database of parking places integrated into vehicles can serve as an example of such a system. Each vehicle acts like one site in a distributed database system. After the vehicle is completed and leaves the car factory, its built-in database is empty. After the system becomes activated, the vehicle starts to query the distributed database for information about parking places in surroundings periodically. When the vehicle receives some data, it saves them into its own built-in database. The sites providing these data could be either other vehicles or parking places.

Based on a similar principle, the vehicle's navigation system could query for data about traffic situation. This way it would be able to provide up-to-date information about traffic jams or accidents to the driver.

In this article a new architecture of DDBS is introduced because, as shown below, classic architecture of DDBS is not suited for dynamic environment of VANETS.

1. Classic architecture of DDBS

To demonstrate the problems of implementing the classic DDBS architecture in a dynamic networks environment, some of the DDBS architecture basics are presented below. They are not supposed to provide an exhausting description of the architecture, but to focus on the parts causing problems with the queries in dynamic networks.

Fig. 1 shows the DDBS architecture from the viewpoint of data organization. It is a simple multi-layer model with four layers. Each one of the layers represents a certain view of the data themselves.

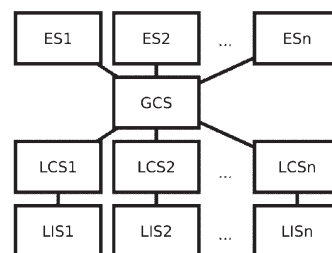

Fig. 1 DDBS reference architecture [7]

1. LIS (Local Internal Scheme) is a physical representation of the data stored in one site. It is an analogy of the internal scheme from centralized databases.
2. LCS (Local Conceptual Scheme) describes the logical organization of data in one site. It is used to handle the data fragmentation and replication.
3. GCS (Global Conceptual Scheme) represents the logical organization of data in the whole distributed database system. This

* Jan Janech, Tomas Baca

Department of Software Technology, Faculty of Management Science and Informatics, University of Zilina, Slovakia
E-mail: jan.janech@kst.uniza.sk

layer is an abstraction of the fact that the database system is distributed.

4. *ES (External Scheme)* represents the user view into the distributed database. Each external scheme defines which parts of the database the user is interested in.

The fact that the user uses only the global conceptual scheme, and they do so by means of the views defined in the external scheme, assures that the user can manipulate with the data regardless of their position in the distributed database system. Therefore it is necessary to have a mapping from every local conceptual scheme to the global conceptual scheme. This mapping, named *GD/D (Global Directory/Dictionary)*, is defined as a part of the distributed database system. Its main role is to provide access to mapping between local conceptual schemes and the global conceptual scheme. Thus it has to be accessible from each of the sites sending queries into the system.

There are several possibilities of storing *GD/D*, however all of them require that the system knows all of its parts all the time. Whether the *GD/D* is stored in one place or distributed throughout the system it has to be accessible as a whole.

This is not possible in a dynamic network. Either in an Ad-Hoc network, or even in a dynamically changing managed network, there is no way to ensure communication between all the sites in the system. Under these circumstances the *GD/D* cannot be used to locate data in a distributed system.

2. Existing solutions

Till now most of the real applications solve this problem by avoiding dynamic networks as a transport channel. They tend to choose reliable network types such as GPRS [3]. However, for a certain type of applications dynamic networks seem to become a suitable alternative. At the present time there are several attempts to create an architecture that would operate in MANET environment [1] [5]. All of them are based on the same principle. There are three types of nodes in the system:

1. *RN - Request Node* - A node that is able to query a database.
2. *DBN - Database Node* - A node that stores data and that is able to process user's queries.
3. *DD - Data Directory Node* - A node that holds *GD/D*. Its responsibility is to create a query plan and to control the execution of the plan.

A request node sends a query to a data directory node which creates a query plan and subsequently delegates an execution of its parts to proper database nodes.

Yet from the used terminology it is obvious that the design emphasizes the network communication. The biggest problem for deployment of distributed databases in the dynamic network environment is the necessity of the knowledge of all the sites in the system. This problem persists in this solution as well because the *GD/D* is still used.

3. Proposed solution

The only way to make sure it is possible to use the distributed database system in the dynamic networks environment is to remove the *GD/D* from the system and replace it with a different principle. As it has been already said, the *GD/D* describes the mapping between the local and global conceptual schemes. Without the mapping, the system does not know where the data are located and how to query them.

Using the *GD/D* in the dynamic networks environment is impossible because it requires knowledge of the whole system (global directory). In a dynamic network every site knows its immediate surroundings only. So querying a distributed database is fairly limited in such environment. The only sites which can be addressed with queries, except the one requesting information, are those in the immediate surroundings in the network. Thus the system naturally creates virtual clusters of sites that can communicate with each other. The clusters overlap, so every site of the cluster can communicate with a different set of sites.

This implies a possibility to move the directory from the global level to the cluster level. This principle may be called *Cluster Directory/Dictionary (CD/D)*. In this way the directory contains only the mapping of the global conceptual schemes of the sites accessible to the local conceptual schemes exclusively. However, there might be problems in this system due to clusters overlapping. Therefore, the local conceptual scheme of each site has to be mapped onto the global conceptual scheme in several *CD/D*.

The cluster has no central site as it is strictly peer-to-peer system; however *CD/D* has to be stored somehow. The only possible way is to store parts of *CD/D* locally only. One site has mapping from the global conceptual scheme onto its own local conceptual scheme. The *CD/D* then consists of all of the local mappings in the cluster.

Executing local queries in such a system is very simple because all of the accessible data and all of the mappings are available, thus not needing to communicate with other sites in the cluster. But since queries are normally done globally all over the whole accessible part of the database [8], the communication between the sites in the cluster is necessary.

Generally there are two possibilities of communication in a database cluster:

- communication with registration into the cluster,
- direct communication of the sites.

The first possibility requires registration of the site within the cluster. By registering each site into the cluster the system promotes the virtual clusters into associated groups of sites. The sites are aware of each other; therefore, they can create and store a complete copy of the *CD/D* locally. Because of the clusters overlapping, each site can have more than one *CD/D* stored. This may simplify the process of queries because every site knows where the data are located.

On the other hand, it is impossible to register every new site into the cluster when it comes to such a rapidly changing environment as VANET certainly is. Either if sites were searching for the nearby clusters or clusters were sending notifications about its presence to the surroundings, these notifications would have to occur so often that the network would be overloaded.

On the contrary, the direct communication does not require any form of registration. Instead, the sites communicate directly with each other. Therefore, the communication solely occurs when it is needed, and the network can be overloaded only by sending too many queries during a short period of time.

However, no site knows the whole CD/D, so the query execution cannot be entrusted to a particular site. Instead of that a query has to be sent to the entire cluster and each site needs to detect whether it can process it or not. The response to the queries can be sent directly to the query site. Since communicating with the whole cluster is required, the query has to be sent as broadcast or multicast messages.

4. Querying database in dynamic network

The new form of the site-to-site communication requires a new architecture of the distributed database system. In spite of that, there are some similarities with the traditional architecture.

There are two defining architectural principles of the traditional distributed database systems. “The first is that the system consists of a (possibly empty) set of query sites and a non-empty set of data sites.”[6] “The second is that each site (query or data) is assumed to consist of a single independent computer.”[6]

These principles are not specific to any particular type of the distributed database environment. So they can be applied equally

to the distributed database system in the dynamic networks environment as well. This leads to the conclusion that there are two basic types of sites:

- *Data site* - contains fragments of the distributed data. From the viewpoint of data organization it preserves the local internal scheme and the local conceptual scheme. As it was stated before, it also contains a part of the CD/D.
- *Query site* - acts as the user’s interface to access the distributed database system. From the data organization point of view it preserves the external scheme.

Queries are sent via the network as broadcast or multicast messages. This way a query site does not know who is to process the query, or if anyone is to process it at all. This restricts the query process in two ways:

- *Asynchronous communication* is required. There is no way how to determine the number of data sites that will respond to the query. Therefore, the querying site has to process responses after they come, instead of waiting for the known number of responses, like it would have to do in the traditional architecture.
- The query syntax needs to be *well structured*, so it can be easily divided into smaller subqueries. The data site which has received the query can only contain a part of the data required for the response (e.g. when the data are horizontally or vertically fragmented). So it has to send one part of the query back to the cluster.

The UML sequence diagram in Fig. 2 shows an example of the communication between querying sites and three data sites. A query in a form of an expression formatted in a certain way is sent by means of a broadcast message into the whole cluster. The data site 1 has some fragments of the queried data, thus it returns them directly to the query site. The data site 2 does not have any data, so it stops the query processing immediately. The data site 3 also has some data; therefore it returns them to the query site. It

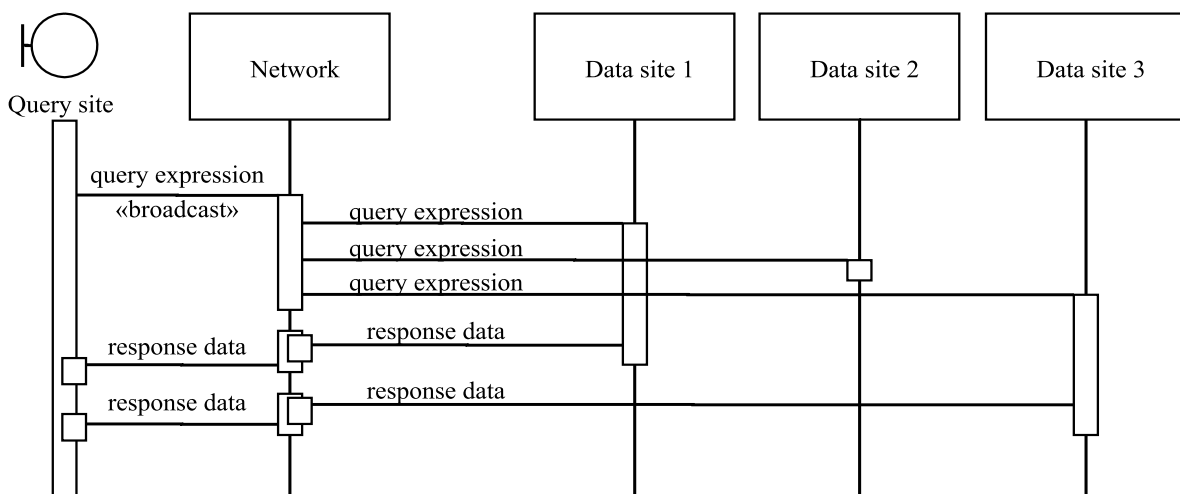

Fig. 2 Processing a query in the cluster

is up to the query site to decide when to stop receiving answers. It is important to be aware of the fact that the connection between any of the sites and the rest of the cluster can be interrupted at any time of processing the query.

Another question is formatting the query. A classic SQL query is not structured very well, and dividing such a query into smaller parts is not a simple task. However, the relational algebra allows doing so. The only problem is the bad format of the query, which resembles natural language rather than a relational algebra expression. Another possibility is using a relational algebra expression directly, in a form of lambda calculus [2] [4]. The lambda function syntax allows to extract any part of the expression, and to evaluate it individually. In this way the user can easily create queries, send them over the network and divide them if necessary.

5. Limitations of new architecture in VANET

The architecture introduced in this article does not intend to be a universal database system. It is a specialized solution for the implementation of distributed database systems in dynamic network environment. Its usage is limited in several ways which is obvious especially when used in VANET. They are caused by rapid movement of vehicles at a large geographic area.

Firstly, it is impossible to access the whole GD/D. Even the CD/D exists only virtually and every node can access only its local part. Thus it's very difficult to optimize queries.

It is impossible to provide referential integrity because the distributed database can be partially or even fully inaccessible. In fact, in different times it has access to different subsets of the database.

For the query site there is no way of how to find out whether it has already received all the data it has requested or if it has to wait longer.

This architecture allows just read-only access to the distributed database. Destructive operations can be executed locally only.

In wireless environment, all the nodes that are within the signal range and use the same channel, share the bandwidth of the transport media. Too many queries and broadcast messages can easily overload the network.

Due to movement of vehicles it is even possible that a data site would become inaccessible to the query site when the query is being processed. Thus it is important for response to be well structured and divided into small fragments. If every fragment can be understood separately, then the query site can make use of received data even if a part of the response has been lost.

Another problem of this architecture is that the implementation of AAA (Authentication, Authorization, Accounting) services is more difficult because the sites are not aware of each other. This can be partially solved by signing the requests electronically, and encrypting the data using the PKI (Public Key Infrastructure).

However signing and encrypting goes against previously mentioned idea of small fragments, because every fragment would have to be signed or encrypted separately which means a lot of extra data.

These limitations are results of the environment rather than the defects of the architecture. Thus the architecture can only be used when these problems are not limiting.

6. Example of an application

VANET does not provide any kind of guarantee of how many data would request site receive as responses. In fact it may receive no data at all. Thus it is not suited for applications where reliable connection is required.

However, if query sites were interested especially in recent data that are specific to their present geographic location and data sites were producing new data on their way. In case that receiving all of the responses is not crucial but receiving at least some of them would pose some kind of advantage, then VANET would represent environment in which this is possible.

A database of parking places integrated into vehicles could serve as an example of such a system. Each vehicle would act like one site in a distributed database system. After the vehicle was completed and left the car factory, its built-in database was empty. After the system became activated, the vehicle started to query the distributed database for a list of parking places periodically. It would receive information from other vehicles about positions of parking places in its proximity.

Positions of parking places could be of course inserted to the vehicle's database using some kind of side channel, for example from data media. However, intelligent parking places are equipped with sensors detecting which slots are available and which are not. This information can be queried and stored by vehicles that are passing closely. Afterward as this vehicle moves to the different location they can be queried by others and provide them with information about situation on that parking place.

7. Conclusion

VANET is a kind of dynamic network with rapidly changing situation and without guarantee of service availability. As such, it is not suited for critical applications which rely on delivery of all the data. However, there are several applications that do not require availability of all the data but rather the most recent data that are present in the relative proximity to the querying site.

Examples of such an application are distributed database of parking places in the town or information about present traffic situation in the region the vehicle is headed toward.

The present architectures of DDBS are not suitable for such an environment. The proposed architecture removes their limita-

tions; however it brings few of its own as a result of principles of dynamic networks.

In a short time a prototype of the system will be created so that its behavior can be tested experimentally. It would be possible then to compare this new architecture with the existing ones.

Acknowledgement:

This contribution is the result of the project implementation: Centre of excellence for systems and services of intelligent transport, ITMS 26220120028 supported by the Research & Development Operational Programme funded by the ERDF.



Agentúra
Ministerstva školstva, vedy, výskumu a športu SR
pre štrukturálne fondy EÚ

"Podporujeme výskumne aktivity na Slovensku/Projekt je spolufinancovaný zo zdrojov EU."

References

- [1] ARTAIL, H., SAFA, H., EL ZINNAR, R., HAMZE, H.: A Distributed Database Framework from Mobile Databases in MANETs, In: *Proc. of 3rd IEEE International Conference on Wireless and Mobile Computing, Networking and Communications*, Oct. 2007, pp. 54-61.
- [2] HILLEBRAND, G.G., KANELAKIS, P.C., MAIRSON, H.G.: Database Query Languages Embedded in the Typed Lambda Calculus, In: *Proc. of 8th IEEE Symposium on Logic in Computer Science*, Montreal, Canada, June 1993, pp 332-343.
- [3] KRSAK, E., HRKUT, P.: *Operatívne riadenie a navigácia zásahových vozidiel hasičskeho zboru pomocou informacneho systemu s distribuovanou architektúrou* [Operative Management and Navigation of Fire Brigade's Vehicles Using Information System with Distributed Architecture], In: GIS : Ostrava, 2008, ISBN 978-80-254-1340-1 (in Slovak).
- [4] MERUNKA, V.: *Objektové modelovani* [Object-oriented Modelling], In: Praha : Alfa Nakladatelství, 2008 (in Czech).
- [5] RAHBAR, A., MOHSENZADEH, M., RAHMANI, A.M.: HDD3M: A New Data Communication Protocol for Heterogeneous Distributed Mobile Databases in Mobile Ad Hoc Networks, In: *Proc. of Intern. Conference on Education Technology and Computer*, April 2009, pp. 93-98.
- [6] OZSU, M. T.: *Distributed database systems*, Available from: <http://softbase.uwaterloo.ca/~ddbms/publications/ozsu/EIC/eic.pdf>.
- [7] OSZU, M. T., VALDURIEZ, P.: *Principles of Distributed Database Systems*. In: Pearson Education, 2nd edition, 1999.
- [8] SOKOLOVSKY, P., POKORNY, J., PETERKA, J.: *Distribuvane databazove systémy* [Distributed Database Systems] In: Academia : Praha, 6th edition, 1992 (in Czech).

Juraj Micek – Jan Kapitulik *

TRANSMIT POWER CONTROL ANALYSIS IN V2X COMMUNICATION SYSTEM

Transmit power control is applied for reduction of transmission power to the level needed for reliable communication. The article describes problematic of transmit power control in ad-hoc V2X communication system applied in intelligent transport system environment.

Key words: transmit power control, inter-vehicle, roadside-to-vehicle, V2X communication system, intelligent transport system

1. Introduction

Present day communication technologies as well as microelectronics allow production of reliable and low energy consumption devices suitable for intelligent transport system (ITS) applications, [1]. Communication platform became integral part of ITS infrastructure.

In 1999, U.S. Federal Communication Commission (FCC) allocated 75 MHz spectrum at 5.9 GHz for Dedicated Short Range Communications (DSRC) devices to be used for car-to-car as well as car-to-road infrastructure communications. The primary goal of above mentioned decision was to improve traffic flow and safety aspects of public road transport.

On 5th August 2008, the EU Committee decided to allocate a frequency band from 5875 to 5905 MHz for ITS applications, which is going to be used on non-exclusive basis. Intelligent trans-

port V2X communication frequency band as well as maximum limit of mean spectral power density (EIRP) is illustrated in Fig. 1, [2]. Inter-vehicle (IVC) and roadside-to-vehicle (R2V) communication is permitted in all of frequency bands.

Channel allocation is defined as specified in table 1, [3]. One physical channel is allocated as a G5CC and four fixed channels are identified as G5SCs.

G5CC and G5SC1 to G5SC4 are dedicated for the following usage:

- The G5CC shall be used for road safety and traffic efficiency applications and may be used for ITS service announcements of services operated on G5SC1 to G5SC4.
- G5SC1 and G5SC2 shall be used for ITS road safety and traffic efficiency applications.
- G5SC3 and G5SC4 shall be used for other ITS user applications.

Fig. 2 presents power density limits of ITS transmitting units at a frequency band of 5.9 GHz. Transmit power limit as well as power density limit for a defined channel is presented in table 1. Maximal transmit power limit equal to 33dBm was defined on the basis of the study of electromagnetic compatibility between ITS and other radio systems for fixed, mobile and satellite services, [4].

The total RF output power and the power spectral density when configured to operate at the highest stated power level of the transmit power control (TPC) range shall not exceed the levels of 33dBm and 23dBm/MHz, respectively. The total RF output power and the power spectral density when configured to operate at the lowest stated power level of the TPC range shall not exceed the levels of 3dBm and -7dBm/MHz, respectively, [4], [7].

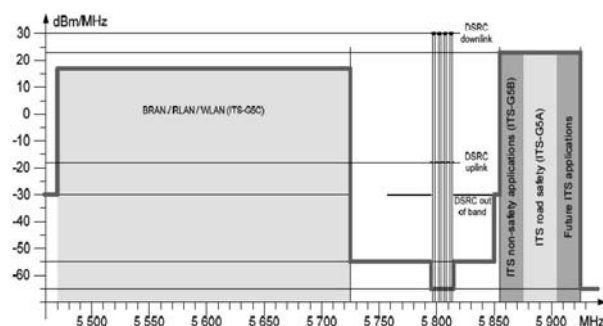

Fig. 1 Maximum limit of mean spectral power density (EIRP)

* Juraj Micek, Jan Kapitulik

Faculty of Management and Informatics, University of Zilina, Slovakia, E-mail: juraj.micek@fri.uniza.sk

European channel allocation

Table 1

Channel type	Centre frequency	Channel number	Channel spacing	Default data rate	TX power limit	TX power density limit
G5CC	5 900 MHz	180	10 MHz	6 Mbit/s	33 dBm EIRP	23 dBm/MHz
G5SC2	5 890 MHz	178	10 MHz	12 Mbit/s	23 dBm EIRP	13 dBm/MHz
G5SC1	5 880 MHz	176	10 MHz	6 Mbit/s	33 dBm EIRP	23 dBm/MHz
G5SC3	5 870 MHz	174	10 MHz	6 Mbit/s	23 dBm EIRP	13 dBm/MHz
G5SC4	5 860 MHz	172	10 MHz	6 Mbit/s	0 dBm EIRP	-10 dBm/MHz

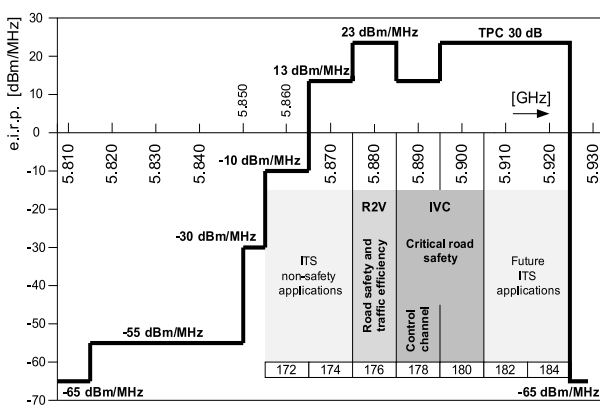

Fig. 2 Power density limits of ITS transmitting units at frequency band 5.9 GHz

V2X communication system allows dynamic control of transmit power of a device in a range of 30 dB. Settings of the transmit power shall be in steps of 0.5 dB controlled by the congestion control manager. Half-duplex and broadcast data transmission mode is supported.

Data rates for 10 MHz channel spacing are defined in table 2, [3].

2. RF Output power analysis

As it was mentioned above, V2X communication system supports dynamic control of transmit power of a device to support scalable and reliable communication between communication units of V2X network. Transmit power control block plays one of main roles in sense of guarantee high quality communication between vehicles as well as roadside units and vehicles.

The analysis of RF output power delivered to the transmit antenna could be principally based on adaptation of Friis trans-

mission equation utilizing a proper radio propagation model that represents path loss between two on-board units (OBU) or roadside unit (RSU) and on-board unit (OBU) of a vehicle. Path loss models accepted by standardization bodies will be used in the analysis.

Friis transmission equation

Mathematical model of Friis transmission equation is as follows, [5]:

$$\frac{P_R}{P_T} = G_T \cdot G_R \cdot \left(\frac{\lambda}{4\pi \cdot d} \right)^2, \quad (1)$$

where:

G_T and G_R are the antenna gain of the transmitting and receiving antennas, respectively, λ is the wavelength, d is the distance. The inverse of the factor in parentheses is the so-called free-space path loss. This simple form applies only under the following ideal conditions:

- The antennas are in unobstructed free space, with no multi-path.
- P_R is understood to be the available power at the receive antenna terminals.
- P_T is understood to be the power delivered to the transmit antenna.
- The bandwidth is narrow enough that a single value for the wavelength can be assumed.

Equation (1) is possible to rewrite to logarithmic form as follows:

$$P_T = P_R - G_T - G_R + L, \quad (2)$$

where:

- P_T is the transmit power in dBm,
- P_R is the received power in dBm,
- G_T is the transmit antenna gain in dBi,
- G_R is the receive antenna gain in dBi,

Data rates and channel spacing

Table 2

Modulation coding scheme (MCS)	0	1	2	3	4	5	6	7
Data rate in Mbit/s 10 MHz channel	3	4.5	6	9	12	18	24	27
Modulation scheme	BPSK	BPSK	QPSK	QPSK	16-QAM	16-QAM	64-QAM	64-QAM
Coding rate R	1/2	3/4	1/2	3/4	1/2	3/4	2/3	3/4

L is the free-space path loss in dB:

$$L = L_0 = 20 \cdot \log_{10} \left(4\pi \cdot \frac{d_0}{\lambda} \right), \quad (3)$$

where:

λ is the carrier wavelength in [m],

d_0 is the breakpoint distance in [m] up to which it is possible to calculate free space path loss using equation (3).

Relation (2) represents obvious form of equation for RF output power level calculation.

ETSI propagation model (European Telecommunications Standards Institute)

ETSI accepted a large scale fading propagation model used for mobile communication applications, [6]. To account for the increased path loss coefficient, the total path loss is split up into two contributions:

$$L = L_0 + L_1, \quad (4)$$

where:

$$L_0 = 20 \cdot \log_{10} \left(4\pi \cdot \frac{d_0}{\lambda} \right), \quad d_0 = 15 \text{ m}, \quad d \leq d_0, \text{ is free space transmission path loss,} \quad (5)$$

$$L_1 = 10 \cdot \log_{10} \left(\frac{d}{d_0} \right)^n, \quad d_0 < d, \text{ is the path loss} \quad (6)$$

assuming a path loss coefficient $n = 2.7$ beyond the breakpoint distance d_0 in [m],

λ is the carrier wavelength in [m],

d is communication distance in [m].

ECC propagation model (Electronic Communications Committee)

Improved path loss factor of a large scale fading propagation model is presented in [7]. Signal degradation beyond the first breakpoint distance is taken into account and path loss corrections are defined. ECC propagation losses L are considered as the conventional expression up to d_0 (3) and the corrected expression beyond:

$$L = L_0 = 20 \cdot \log_{10} \left(4\pi \cdot \frac{d_0}{\lambda} \right), \quad d \leq d_0 \quad (7)$$

$$L = L_1 = 20 \cdot \log_{10} \left(4\pi \cdot \frac{d_0}{\lambda} \right) + 10n_0 \cdot 10 \log_{10} \left(\frac{d}{d_0} \right), \quad d_0 < d \leq d_1 \quad (8)$$

$$L = L_2 = 20 \cdot \log_{10} \left(4\pi \cdot \frac{d_0}{\lambda} \right) + 10n_0 \cdot 10 \log_{10} \left(\frac{d}{d_0} \right) + 10n_1 \cdot 10 \log_{10} \left(\frac{d}{d_1} \right), \quad d_1 < d \quad (9)$$

where:

λ is the carrier wavelength in [m],

d is communication distance in [m],

d_0 is the breakpoint distance in [m]

(up to which it is possible to calculate free space path loss),

d_1 is the breakpoint distance in [m],

n_0, n_1 are path loss factors.

ECC performed studies to estimate the impact from FWA (Fixed Wireless Access) systems on the RTTE on-board units (OBU), including false wake up detection and its effect on OBU battery life. Breakpoint distances and path loss factors were defined on the basis of the studies, table 3.

Parameters of propagation

Table 3

	Urban	Suburban	Rural
Breakpoint distance d_0 [m]	64	128	256
Path loss factor n_0 beyond the first breakpoint	3.8	3.3	2.8
Breakpoint distance d_1 [m]	128	256	1024
Path loss factor n_1 beyond the second breakpoint	4.3	3.8	3.3

3. Simulation

Referring to equation (2) and radio propagation models, it is clear that RF output power level of transmitter, P_T , is depended on:

P_R receiver sensitivity in dBm,

G_T transmit antenna gain in dBi,

G_R receive antenna gain in dBi,

L path loss propagation model in dB,

λ carrier wavelength in [m],

d communication distance in [m],

d_0, d_1 breakpoint distances in [m],

n_0, n_1 path loss factors.

Receiver sensitivity: P_R [dBm]

The minimum receive sensitivity (OBU or RSU) specifies the required receive input power (i.e., at the antenna connection) including an implementation margin of 5 dB for a receiver noise figure of 10 dB and a BER of 10^{-5} , table 4 [8]. P_R is defined in compliance with a communication channel bandwidth for corresponding data rate.

Referring to simulation, value of P_R is selected on the basis of information in table 1:

$$P_R = -72 \text{ dBm} \quad (BW = 10 \text{ MHz, data rate} = 6 \text{ Mbits/s}).$$

Transmit and receive antenna gains: G_T, G_R [dBi]

ITS applications expect 10 dBi antenna gain for road-side unit (RSU), 8 dBi or 5 dBi antenna gain for on-board unit (OBU) of a vehicle, [4].

Appealing to simulation, values of G_T and G_R are selected in compliance with Inter-vehicle (IVC - channels numbers: 178, 180)

or roadside-to-vehicle (R2V – channel number: 176) communication: $G_T = 5\text{dBi}$, $G_R = 5\text{dBi}$ (IVC communication).

Path loss propagation model: L [dB]

Minimum receiver sensitivity for a BW of 10 MHz Table 4

Data rate [Mbits/s]	Minimum sensitivity [dBm]
3	-85
4.5	-84
6	-72
9	-80
12	-77
18	-70
24	-69
27	-67

Referring to simulation purposes, a radio wireless propagation model must be proposed in compliance with practical applications. Relating to above mentioned models, value of carrier wavelength λ is corresponding with the channel type (channel number) used for ITS services, [3]: $\lambda = 0.0508\text{m}$ (channel type: G5CC; channel number: 180; centre frequency 5.9 GHz). Breakpoint distances d_0 , d_1 as well as path loss factors n_0 , n_1 are defined by practical measurements or standards: equations (3), (5), (6) and table 3.

Communication distance (range): d [m]

It is distance between two communication units, i.e. transmitter and receiver (RSU and OBU, OBU and OBU). Appealing to simulation, values of d are defined up to the communication range limit: 1000 m, table 5.

Table 5 presents results of calculations based on theoretical models representing relation of TX power level of the transmit unit and the distance between on-board units of two vehicles. Calculations were done for several radio propagation models. A free-space model (M1) expects no obstacles between transmitter and receiver, i.e. propagated waveform is not degraded (path loss coefficient $n = 2$). ETSI model (M2) expects line-of-sight communication with severely destructed first Fresnel zone (path loss coefficient is in the range: $n = 2.5 \dots 3$; $n = 2.7$ was selected; the pass loss coefficient for non-line-of-sight conditions would be in the range: $n = 3 \dots 5$). ECC models (M3, M4, M5) were derived from mobile communi-

cation ones. They respect three different ITS environments: urban, suburban, rural. Path loss coefficients were adapted for ITS applications.

Referring to differences between estimated values for a defined distance of the models (table 5), validity of the models had to be verified by practical measurements in ITS environments. Unfortunately, this step was impossible to realize due to lack of technical equipment. That is why the results of simulation could be interpreted only on theoretical basis.

TPC dynamic range for channel number: 180 is 30dB. Minimal TX power level is defined on the level of 3dBm, maximal is equal to 33dBm. Appealing to table 5, theoretical TX power values lower than minimal limit were replaced by 3dBm and higher ones than maximal limit by 33dBm. Adaptation of the values is in compliance with defined TX power limits as well as practical realization of TPC block. Increasing TX power to minimal limit will improve reliability of communication between vehicles. Unfortunately, decreasing TX power to maximal limit will shorten communication distance, i.e. communication range limit 1000 m does not need to be met. Looking for the solution to solve this topic, communication range limits at maximal TX power = 33dBm were calculated, table 6.

Communication range limits at maximal transmit power 33 dBm Table 6

Models	Communication range limit [m]	
	$G_R = 5\text{ dBi}$	$G_R = 8\text{ dBi}$
<i>Free-space model</i> M1	1278	1805
<i>ETSI model</i> M2	405	523
<i>ECC model: Urban</i> M3	279	328
<i>ECC model: Suburban</i> M4	471	565
<i>ECC model: Rural</i> M5	933	1033

The values in table 6 show that improvement of communication range limits for inter-vehicle communication (IVC) via selected channel type and defined minimum receiver sensitivity could be realized by increasing the receiver antenna gain of the vehicle. Models M2, M3 and M4 did not meet expected 1000 m limit neither after increasing the receiver antenna gain. In this case it

Dependency of TX power level of the transmit unit on the distance between OBUs of two vehicles (channel number: 180; TX power = $P_T + G_T$) Table 5

Models	Distance [m]	10	50	100	250	500	1000
<i>Free-space model</i> M1	TX power [dBm] EIRP	3	5	11	19	25	31
<i>ETSI model</i> M2	TX power [dBm] EIRP	3	8.5	17	27.5	33	33
<i>ECC model Urban</i> M3	TX power [dBm] EIRP	3	5	14.5	31	33	33
<i>ECC model Suburban</i> M4	TX power [dBm] EIRP	3	5	11	23	33	33
<i>ECC model Rural</i> M5	TX power [dBm] EIRP	3	5	11	19	27.5	33

would be necessary to arrange OBU with better minimum receiver sensitivity. Unfortunately, data rate had to be decreased to guarantee reliable communication. Referring to values in tables 5 and 6, it is possible to conclude that ECC models estimate TX power in compliance with specific features of ITS environments.

Appealing to values of TX power in tables 5 and 6, it is possible to state:

- *Model M1*: in spite of the fact that communication range limit of 1000m is met and full TPC range of 30 dB is utilized the model would be valid only for very short distance free-space IVC, R2V communication;
- *Model M2*: communication range is shorter than 523 m; better TX power estimation could be expected for urban and suburban environments rather than rural one;
- *Model M3*: communication range is shorter than 328 m; model could be used for TX power estimation in case of urban environment;
- *Model M4*: communication range is shorter than 565 m; model could be used for TX power estimation in case of suburban environment;
- *Model M5*: communication range met the limit of 1000 m; model could be used for TX power estimation in case of rural environment;

4. Conclusion

V2X communication system plays a core role of inter-vehicle as well as road-side-to-vehicle communication allowing development of services focused on the improvement of road safety and traffic efficiency (driving assistance: co-operative awareness, road hazard warning; speed management; co-operative navigation; location based services, etc.). The article presents fundamentals of transmit power control analysis including simulation results for inter-vehicle communication. Road-side-to-vehicle communication could be analyzed in a similar way. Future research steps would be focused on: validation of presented theoretical models, incorporating traffic density aspects into models and analysis of transmit power control from the basic set of applications point of view.

Acknowledgement:

This contribution is the result of the project implementation: **Centre of excellence for systems and services of intelligent transport**, ITMS 26220120028 supported by the Research & Development Operational Programme funded by the ERDF.



Agentúra
Ministerstva školstva, vedy, výskumu a športu SR
pre štrukturálne fondy EÚ

"Podporujeme výskumne aktivity na Slovensku/Projekt je spolufinancovaný zo zdrojov EU."

References

- [1] MICEK, J., KAPITULIK, J.: *Car-to-car Communication System*. In: Proc. of the International Multiconference on Computer Science and Information Technology, Vol. 4, 2009, ISBN 978-83-60810-22-4, ISSN 1896-7094, pp. 627-631.
- [2] ETSI TR 102-492-2 V1.1.1, July 2006: *Electromagnetic Compatibility and Radio Spectrum Matters (ERM)*.
- [3] ETSI ES 202 663 V1.1.0, November 2009: ITS; *Physical and Medium Access Control Layer*.
- [4] ETSI EN 302 571 V1.1.1, September 2008: ITS; *Radiocommunications Equipment Operating in the 5 855 MHz to 5 925 MHz frequency band*.
- [5] www.wikipedia.com, Friis Transmission Equation.
- [6] SKLAR, B.: *Digital Communications, Fundamentals and Applications*. 2001, Prentice Hall, ISBN 0-13-084788-7.
- [7] ECC Report 101: *Compatibility Studies in the Band 5855- 5925 MHz between ITS and other Systems*.
- [8] ETSI TR 102-492-1 V1.1.1, June 2005: *Electromagnetic Compatibility and Radio Spectrum Matters - Part 2, ITS*.

Jaroslav Janacek – Jan Sirc *

THE COLUMN GENERATION TECHNIQUE FOR PUBLIC TRANSPORT LINE PLANNING BY IP-SOLVER

The paper deals with an application of the column generation method to the public transport line planning making use of a common optimization environment. The authors focus on the opportunities offered by the optimization software for the column optimization and for machine approach to the process of line planning. The paper resumes the former approach to the transport line planning based on line selection from a large set of all sensible lines and, on the contrary to the former approach, introduces the column generation method for a new route design. A case study from practice is used to compare both approaches and to point out their advantages and disadvantages.

1. Introduction

The public transport line planning is a crucial deal for each designer involved. In general, the planning process comprises several stages which start with a line route design and finish with a driver scheduling [2], [4], [7]. We shall concentrate on the first stage only where a system of line routes is designed. Even at this stage, various objectives to the design can be applied to make the transportation system more attractive for potential passengers. Depending on the chosen objective, various sorts of information about origin-destination passenger flows are required and the fact must be taken into account that any specific information need not be available at the beginning of the planning process.

We mention here an approach which needs only information about demand for transportation on the links of an underlying transportation network. The objective of line system designing is to improve service of the link with the worst demand satisfaction. The link demand satisfaction is evaluated as the ratio of the number of passengers who want to travel along the link in one hour and the total number of seats which are at disposal on the link within one-hour period. The resulting system of line routes must comply with a constrained number of vehicles which can be assigned to individual lines.

In this paper we come out from the approach called "PRIVOL" [3], [5], [8] which starts with a large redundant set of pre-designed lines covering all links of the considered transportation network. A linear program is formulated in this original approach where disposable vehicles are assigned to individual lines and the worst relative link demand satisfaction is maximized. This linear problem is solved to optimality and some lines are subsequently discharged from the starting set based on a number of assigned vehicles. This process of line elimination can be repeated several times until

a convenient system of line routes is obtained. The major disadvantage of this approach consists in the necessity to design the huge starting line set in advance. Furthermore, it must be taken into account that extent of the line set does not assure that it contains the most convenient lines for the system. This approach does not design a line really, but it only selects some lines from the starting set. To enable a link route generation under the above-mentioned objective, we suggest here an approach based on the column generation method [1], [6]. We will show how to use the standard optimization environment for the method implementation so that a common designer who is not supported by a team of programmers and other informatics professionals can use this approach.

2. Model of the original line elimination approach

The simplest case of the line elimination approach assumes that there is a number c of vehicles which form a homogenous fleet. Each vehicle has the same capacity K (number of seats). The graph of transportation network consists of a set of nodes U and a set of links H . An hour's demand for transportation on link h is described by intensity q_h . The symbol t_h denotes the time which is necessary for traversing the link h by a vehicle of the considered homogenous fleet. Let the symbol L denote the starting set of line routes where each route is given by some collection of links from H . In the following models we shall use notation L_h and H , where L_h denotes the set of line routes serving the link h and H_l denotes the set of all links forming the line route l . The symbol N_l denotes so-called frequency of vehicles assigned to the line route l which is the number showing how many times a vehicle is able to run the route within one hour. It is obvious that the equation $N_l = 1/T_l$ holds where T_l denotes the time necessary for traversing the route l . In our case we assume that (1) holds.

* Jaroslav Janacek¹, Jan Sirc²

¹ Department of Transportation Networks, Faculty of Management and Informatics, University of Zilina, Slovakia, E-mail: jaroslav.janacek@fri.uniza.sk,

² Institute of Transport, Faculty of Mechanical Engineering, VSB – Technical University of Ostrava, Czech Republic

$$T_l = \sum_{h \in H_l} t_h \quad (1)$$

The original line elimination approach [4] formulates the linear model using integer variable x_l modeling the decision on a number of vehicles which should be assigned to the individual line route l .

Let variable y represent a lower bound of the relative link demand satisfaction and let coefficient K_h denote the ratio K/q_h , then a model of the vehicle assignment problem can be formulated as follows:

$$\text{Maximize } y \quad (2)$$

$$\text{Subject to } \sum_{l \in L} x_l \leq c \quad (3)$$

$$y - \sum_{l \in L_h} K_h N_l x_l \leq 0 \text{ for } h \in H \quad (4)$$

$$x_l \in Z^+ \text{ for } l \in L \quad (5)$$

$$y \geq 0 \quad (6)$$

Constraint (3) of the model (2)-(6) ensures that the number of assigned vehicles does not exceed the limit c . The constraints (4) link up the lower bound y to the individual link ratios (7),

$$\frac{K \sum_{l \in L_h} N_l x_l}{q_h} \quad (7)$$

where the numerator expresses the number of seats which are offered to passengers on the link h within one hour period and the denominator corresponds with the number of passengers who want to travel along the link h in one hour. The LP-relaxation of the model (2)-(6) is solved as a part of the original approach [4] and the link route with minimal value of x_l is discharged from the set L .

3 The column generation method

In general, the column generation method is used in connection with such problems where the most of columns of the associated linear model has the same structure. Furthermore, the solved problem must be formulated so that each addition of a column to the model enlarges the set of feasible solutions. Then a better solution can be found in the enlarged set than in the previous one. In addition, such method must be derived which enables to evaluate possible improvement of the given objective function or to find that no improvement can be reached by addition of any column. The problem (2)-(6) has these necessary properties. The column

connected with the variable x_l corresponds with the unique line route and any addition of a new line route to the set L enlarges the set of feasible solutions.

Now we derive a possible method of column evaluation using the theory of duality [6]. Let L denote an original set of line routes. Let us denote the LP-relaxation of the model (2)-(6) as the primal problem. Introducing dual variable v_h for each constraint h of the constraint system (4) and dual variable w for the constraint (3), a dual problem of the primal one can be formulated as follows:

$$\text{Minimize } cw \quad (8)$$

$$\text{Subject to } \sum_{h \in H} v_h \geq 1 \quad (9)$$

$$w - \sum_{h \in H_l} K_h N_l v_h \geq 0 \text{ for } l \in L \quad (10)$$

$$v_h \geq 0 \text{ for } h \in H \quad (11)$$

$$w \geq 0. \quad (12)$$

For the optimal solutions (x^*, y^*) and (v^*, w^*) of the primal and dual problems respectively, the equation (13) holds:

$$cw^* = y^*. \quad (13)$$

Now, let us consider a new line route r given by the links of H_r . Let us define coefficients of the associated column A_r in the following way:

$$a_{hr} = K_h N_r \text{ if } h \in H \text{ and } a_{hr} = 0 \text{ otherwise} \quad (14)$$

The primal enlarged problem (2)-(6) can be reformulated for the enlarged set $L \cup \{r\}$ of line routes as follows:

$$\text{Maximize } y \quad (15)$$

$$\text{Subject to } \sum_{l \in L} x_l + x_r \leq c \quad (16)$$

$$y - \sum_{l \in L_h} K_h N_l x_l - a_{hr} x_r \leq 0 \text{ for } h \in H \quad (17)$$

$$x_l \geq 0 \text{ for } l \in L \cup \{r\} \quad (18)$$

$$y \geq 0 \quad (19)$$

For any feasible solution of (15)-(19) and for the optimal solution (v^*, w^*) of (8)-(12), we can derive the following inequality:

$$\begin{aligned} y &\leq y + w^* \left(c - \sum_{l \in L} x_l - x_r \right) + \sum_{h \in H} v_h^* \left(\sum_{l \in L_h} K_h N_l x_l + a_{hr} x_r - y \right) = \\ &= y + cw^* - \sum_{l \in L} w^* x_l - w^* x_r - \sum_{h \in H} v_h^* y + \sum_{l \in L, h \in H_l} v_h^* K_h N_l x_l + \sum_{h \in H} v_h^* a_{hr} x_r = \\ &= cw^* + y \left(1 - \sum_{h \in H} v_h^* \right) + \sum_{l \in L} x_l \left(-w^* + \sum_{h \in H_l} K_h N_l v_h^* \right) + x_r \left(-w^* + \sum_{h \in H} a_{hr} v_h^* \right) \end{aligned} \quad (20)$$

Since the expressions in brackets of the second and third items of the resulting right-hand-side of (20) are negative (see dual constraints (9) and (10)), the following inequality holds:

$$y \leq cw^* + x_r \left(-w^* + \sum_{h \in H} a_{hr} v_h^* \right) \quad (21)$$

Taking into consideration the equation (13), we obtain:

$$y - y^* \leq x_r \left(-w^* + \sum_{h \in H} K_h N_r v_h^* \right) \quad (22)$$

Thus we can find that the inequality (23) is necessary for the case when the addition of a column A_r is able to improve the objective function y .

$$w^* \leq \sum_{h \in H} K_h N_r v_h^* \quad (23)$$

The inequality (23) can be rearranged to the form:

$$w^* T_r \leq \sum_{h \in H} K_h v_h^*, \quad (24)$$

which is

$$w^* \sum_{h \in H} t_h \leq \sum_{h \in H} K_h v_h^*. \quad (25)$$

The inequality (25) can be rewritten as

$$0 \leq \sum_{h \in H} (K_h v_h^* - t_h w^*). \quad (26)$$

After these preliminaries, we can assert that a new line route r can improve the objective function (15) only if the right-hand-side of (26) is positive. To find if such a line route exists we formulate the problem of finding the line route which maximizes the right-hand-side of (26). For this purpose we introduce a set of binary variables $z_h \in \{0,1\}$ for $h \in H$ where the variable z_h takes the value of 1 if and only if the link h belongs to the generated line route. If a network sub-graph fulfilling the conservative constraints (28) for each node of the network is accepted as a feasible line route then the line route generation problem can be stated as follows:

$$\text{Maximize } \sum_{h \in H} (K_h v_h^* - t_h w^*) z_h \quad (27)$$

$$\text{Subject to } \sum_{h \in H^{in}(u)} z_h = \sum_{h \in H^{out}(u)} z_h \quad \text{for } u \in U \quad (28)$$

$$z_h \in \{0,1\} \quad \text{for } h \in H \quad (29)$$

The link sets $H^{in}(u)$ and $H^{out}(u)$ denote a set of all the links coming into the node u and a set of all the links going out of the node u respectively.

If an optimal solution z^* of the problem (27)–(28) has a positive value of the objective function (27), then the solution forms an improving line route. In the opposite case, no improving line route exists at all.

4. Exploitation of XPRESS-IVE tool

The theoretical derivation of the improving line route generation problem is only one step on the way to the usable tool of a line route system design. As for the developed approach is addressed to a common line system designer, we rearranged the models so that the common commercial optimisation environment [9], [10] can be used. Furthermore, we realize that a route designed by solving the model (27)–(29) need not be a feasible route in the concrete real transportation network. Because of this fact we followed the idea that a designer should have a possibility to evaluate the designed route-column and depending on its practical feasibility or unfeasibility, he should be able to accept or refuse the route for the next processing. That is why we implemented the column generation method in two programs written in the programming language Mosel and we decompose the method into a series of individual steps. Each step is represented by one run of the first program consisting of two optimisation processes where the first process solves LP-relaxation of the vehicle assignment problem (2)–(6) and the second one solves the column generation problem (27)–(29) for the shadow prices (optimal values of dual variables) corresponding with the first problem.

If the solving process of the second problem gives an improving column, then the generated column enlarges the starting LP-relaxation problem and the enlarged problem is saved to a unified file. This way, the process of the column generation method can be interrupted after each step and, if necessary, the generated column can be modified in the file. The scheme of the first program is depicted in Fig. 1.

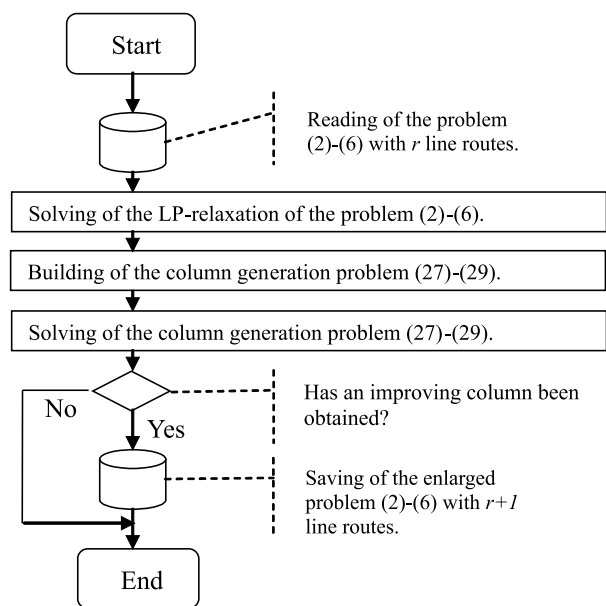

Fig. 1 Scheme of the first program

The second program solves the integer programming problem (2)–(6). This program can be applied on each version of the

unified file in which data describing the vehicle assignment problem are saved. It means that after each step (column generation) it is possible to evaluate quality of the current system of line routes.

5. Case study

To verify the developed method, we made use of the real transportation network of Frydek-Mistek in the Czech Republic. The transportation network consists of 17 nodes and 46 links. The intensities q_h and travel times t_h for each link of the transportation network were also taken from the real traffic situation of the town. The vehicle fleet consists of 23 vehicles.

For our experiments we have a system of 9 real line routes at disposal. This real system of routes is reported as RealS09 hereafter in reported study. One of the line routes serves all the links of the transportation network. The biggest line route was taken as a basis for forming a generated system of 12 line routes denoted as GenS12. The generated system was formed by a series of column generation program runs which formed 22 line routes. As some of the generated routes were too small or they did not fulfil some local condition of feasibility, the generated system was revised, some routes were connected and some were discharged. Thus the system GenS12 of twelve feasible routes was obtained.

The numerical experiments were done with both starting line route systems to verify the column generation program and reveal trends of associated parameters. Eleven steps of column generation were performed with each starting system which means that systems with a number of lines varying from 10 to 20 were obtained for RealS09 and systems with a number of lines varying from 13 to 23 were obtained for GenS12. Solving the problem (2)-(6) corresponding with the enlarged system followed each column generation. The following parameters were observed:

- y_{LP} - optimal value of the lowest relative link demand satisfaction of LP-relaxation of the problem (2)-(6),
- y_I - optimal value of the lowest relative link demand satisfaction of integer solution of the problem (2)-(6),
- NoUL - number of used links in optimal integer solution of the problem (2)-(6).

The results for RealS09 and GenS12 are reported in Table 1 and Table 2 respectively. The number of line routes denoted as

Optimal values of parameters obtained by the series of experiments starting with RealS09 Table 1

NoL	9	10	11	12	13	14
y_{LP}	1.773	1.820	1.873	1.883	1.895	1.977
y_I	1.673	1.673	1.740	1.740	1.771	1.777
NoUL	9	10	10	10	11	12
NoL	15	16	17	18	19	20
y_{LP}	1.988	2.011	2.029	2.045	2.088	2.096
y_I	1.811	1.863	1.863	1.863	1.917	1.917
NoUL	12	13	13	13	12	12

NoL is used in the tables to distinguish the evaluated systems of line routes.

Optimal values of parameters obtained by the series of experiments starting with GenS12 Table 2

NoL	12	13	14	15	16	17
y_{LP}	1.700	1.835	1.910	1.994	2.025	2.115
y_I	1.587	1.728	1.752	1.862	1.862	1.907
NoUL	8	9	10	11	11	11
NoL	18	19	20	21	22	23
y_{LP}	2.159	2.169	2.178	2.185	2.186	2.188
y_I	1.907	1.914	1.914	1.914	1.914	1.933
NoUL	11	13	13	13	13	15

All experiments were performed on a notebook with parameters Core 2 Duo 2GHz 2GB RAM. The individual computing times are not reported here, but we can assert that no time of program run exceeded one second.

6. Conclusions

We have developed the column generation approach for a special case of a line route design problem where the worst relative link demand satisfaction is optimized. The resulting method was suggested so that it can be easily implemented in the common commercial optimization environment XPRESS-IVE and man-machine approach can be included to the process of individual route generation. We verified the method by performing the suggested column generation process with two starting sets of line routes (GenS12 and RealS09). From the results reported in tables 1 and 2 we found that each column generation brings some improvement of the objective function of an optimal solution obtained for LP-relaxation. Nevertheless, an improvement of LP-relaxation solution need not be accompanied by any improvement in an optimal integer solution. Thus a next improving line can be obtained after several column generations. The experiments also showed that even if the process starts from the better starting line route system (compare y_I for NoL = 9 in Table 1 with y_I for NoL = 12 in Table 2), the same number of column generations could give a worse result (compare y_I for NoL = 20 in Table 1 with y_I for NoL = 23 in Table 2). In general, we can state that the column generation process performed on XPRESS-IVE environment together with a man-machine approach represents a valuable tool for a line route designer.

Further research in this field can be focused on the following directions. First, similar approaches could be developed for other criteria which are used for the construction of an objective function. Next, more complex models for line route generation can be studied to produce more convenient routes and avoid their local infeasibilities.

Acknowledgement:

This contribution is the result of the project implementation:
Centre of excellence for systems and services of intelligent trans-

port, ITMS 26220120028 supported by the Research & Development Operational Programme funded by the ERDF.



Agentúra
Ministerstva školstva, vedy, výskumu a športu SR
pre štrukturálne fondy EÚ

"Podporujeme výskumne aktivity na Slovensku/Projekt je spolufinancovaný zo zdrojov EÚ."

References

- [1] BORNDORFER, R., GROTSCHER, M., PFETSCH, M.E.: A Column-generation Approach to Line Planning in Public Transport. *Transportation Science*, 41(1), pp. 123-132, 2007.
- [2] CEDER, A., WILSON, N.H.: Bus Network Design. *Transp. Research Part B*, 20(4), pp. 331-344, 1986.
- [3] CERNÝ, J., KLUVANEK P.: *Bases of Mathematical Theory of Transport*, VEDA : Bratislava, 1991, (in Slovak).
- [4] JANOSIKOVA, L., BLATON, M., TEICHMANN, D.: *Design of Urban Public Transport Lines as a Multiple Criteria Optimisation Problem*. In: Proc. of the conference "Urban Transport 2010", Cyprus, May 4-7, 2010, to appear.
- [5] PESKO, S.: Support of Operations Research Methods for Line System Design. *Proc. of the 6th Int. Conf. On Urban Transportation Infrastructure*. University of Zilina : Zilina, 2008 (in Slovak).
- [6] REEVES, C. R. ed.: *Modern Heuristic Techniques for Combinatorial Problems*. Oxford Blackwell Scientific Publications, 1993, p. 320.
- [7] SUROVEC, P.: *Operations and Economics of Road Transport*. Vysoka skola banska : Ostrava, 2000, (in Czech).
- [8] TEICHMANN, D.: On Several Mathematical Model Modifications of Vehicle Assignment to Lines of Town Public Transport. *New Railway Technique*, 17(1), pp. 20-23, 2009 (in Czech).
- [9] XPRESS-MP Manual "Getting Started". Dash Associates : Blisworth, UK, 2005, p. 105.
- [10] XPRESS-Mosel "User guide". Dash Associates : Blisworth, 2005, UK, p. 99.

Emil Krsak – Hynek Bachraty – Vlastimil Polach *

GTN – INFORMATION SYSTEM SUPPORTING THE DISPATCHER AND REMOTE TRACKS CONTROL

When constructing new corridor tracks, but also when reconstructing the existing ones of all categories, new significant improvements and innovations occur in the construction area. Consequently, the same phenomenon occurs in the newly installed securing, interlocking and signalling equipment, and generally enabling also remote track control. The traffic information and controlling system (hereinafter the GTN) being developed by the Software Technologies Department of the University of Zilina in cooperation with the AZD Praha Company, represents a graphical and technological extension of the electronic signalling equipment. It contains a compact data, technology and software model of railway operation, enabling to receive information from the securing, interlocking and signalling equipment, as well as from other information and controlling railway systems, about trains' movement. It also enables to save, display and document the traffic progression, trains movement and technological operations on them. Last but not least, it provides opportunity to display the anticipated prognosis of the traffic situation, and transmit information about trains movement towards external IS, e. g. the passenger information systems at the stations etc.

Currently, the GTN system has been implemented and used in several versions on the Czech and Slovak Railways tracks. Hereby we would like to introduce its latest solution based on distributed architecture using a database system.

1. Introduction

In the Central Europe countries, construction works associated with modernizing or building railway tracks belong to the largest construction projects of current times. This corresponds to the amount of the investments needed. Therefore, it would be a disappointment and loss, if using the tracks were devaluated by low quality of transport technologies following the construction part. As a rule then, in both, the Czech and Slovak Republic the modernized tracks have been equipped with a modern security remote-con-

trolled signalling equipment (hereinafter DOZ – remote centralized traffic control). It enables to control railway traffic from various workplaces many tens of kilometres distant from each other, and to centralize transportation processes control.

By 'control' we mean the possibility of organizing traffic by means of determining the train runs order, their overtaking, using station and track rails etc. At the centralized dispatcher places (CDP), the controlling process is connected directly to the electronic interlocking control, or stations security signalling equipment



Fig. 1 CDP Prerov, Large dispatcher's room No. 1 – General view of the dispatcher and operator centralised control place

* Emil Krsak¹, Hynek Bachraty¹, Vlastimil Polach²

¹ Department of Software Technologies, Faculty of Management Science and Informatics, University of Zilina, Slovakia, E-mail: emil.krsak@fri.uniza.sk

² AZD Praha, Czech Republic

control respectively. This includes, e. g., creating the train routes through particular stations, entering the information on anticipated departures or specifying some events, such as a train origination, expiration and renumbering, shifting at the station etc.

The way the operating staff work combines the train and station dispatchers' activities. The software controlling the signalling equipment is usually able to supervise and change the state of the infrastructure individual elements, to supervise the rails occupation by train vehicles, and to identify in the occupation changes the individual trains movement.

In Slovakia, tracks modernizing has still been in the initial phase but in the Czech Republic it already started in the half of the 90's. The fact that dispatcher places originating at modernized tracks were equipped with computer technologies, interconnected by a reliable network and operated by computer-skilled staff, was very inspirational for further development. In that period the AZD Praha company addressed the Software Technologies Department of the University of Zilina, suggesting to develop and implement an information system using and developing possibilities of a modern securing, interlocking and signalling equipment. On the basis of the requests we developed the GTN – an information system to support the DOZ's dispatcher's decision-making processes. The GTN stands for graphic-technological extension of the signalling equipment. The system has been directly connected to the electronic ESA interlockings by the AZD Praha, supplied to a new corridor and later also to other tracks.

Since the first GTN version was implemented, eight years have already passed, and currently the system works on hundreds of kilometres of tracks controlled by the AZD Praha signalling equipment. In our article we are going to concentrate on the GTN latest version implemented e. g. at the international corridor track (OBB/, ZSR) Breclav – Prerov – Petrovice (/PKP), e. i. VI. TEN corridor in the Czech Republic. Technical, technological and operational aspects of the transportation centralized control on the Prerov – Břeclav track (CDP Prerov) are introduced in [5].

2. Technological links and GTN usage

The main role of the GTN system is to gain, identify and interpret data on trains runs from the connected DOZ as well as from other sources. It can document, archive and display the information for the operation staff in a transparent way, including displaying the traffic prognosis. The system also sends out some of the acquired information into other systems. The grounds of the GTN activities is the data model of one-train run, and the traffic situation model created from trains runs and network description. The current transport plan has been acquired from the data of the SENA and ZONA systems, being developed also at the Software Technologies Department of the University of Zilina, and used by the Czech Railways (CD) and Slovak Railways (ZSR) to construct the train time-table plans.

The GTN is a system supporting the decision-making process related to controlling transportation processes. Displaying the traffic

prognosis has been its significant part. Another one is disburdening the operation staff from routine and duplicate works (conducting documentation, sending identical information into several systems, confirming the announcements reception and so on), by which the dispatcher gains time for the decision-making itself. What is also important is to ensure automatized, fast and precise information transfer.

From the viewpoint of activities, it is possible to divide the work done by the GTN into four basic fields which we are about to describe briefly below.

2.1. Information entering the GTN from the electronic signalling equipment

The main entry of the data about current traffic for the GTN is provided via communication with some type of electronic interlocking installed by the AZD Praha Company. From the controlling interlocking we are able to gain information on the trains numbers movement in a so called stacks, corresponding to the individual station and track rails. First, the train number appears in them, then it changes some of the specific state signs, and, finally, it frees the stacks. Except that, in some situations we also acquire an information on the kind of action the interlocking operation staff have performed. We use the information to put together the data about the train run. A standard procedure in each station is creating a train route, train arrival, anticipated and actual train departure and freeing the rail. At large, we observe more than 30 different actions on the train, such as the beginning and finishing the train run, sidetracking the train, changing the train route, shifting the train, riding on emergency signal, train-confirming signal, several types of train renumbering, departure and return of the train from the branch line to the track, the train returning from the track, a train-run expiration on the track etc. Correct and precise comparison of time data of the actual and planned rides requires (regarding the disunited methodology of various units of the railways) to work in some of the time and data corrections of the acquired information.

Although the GTN system also enables manual entering of the train run information, this is just a backup in case of interlocking or communication with interlocking fail. The ability to gain all of the train run data in the controlled area automatically, without the necessity of the operation staff's assistance, represents a significant element in the effectiveness as well as punctuality and reliability of their work. Moreover, the data acquired from the signalling equipment, which, to make sure it works correctly, has to observe the train movement duly, are unimpugnable and demonstrably precise. Thus the seminal traffic documentation of new quality originates.

2.2 Information entering the GTN from the all-state railway network and external IS

Communication with the DOZ enables automatic acquisition of the train run information until the moment the train occurs in

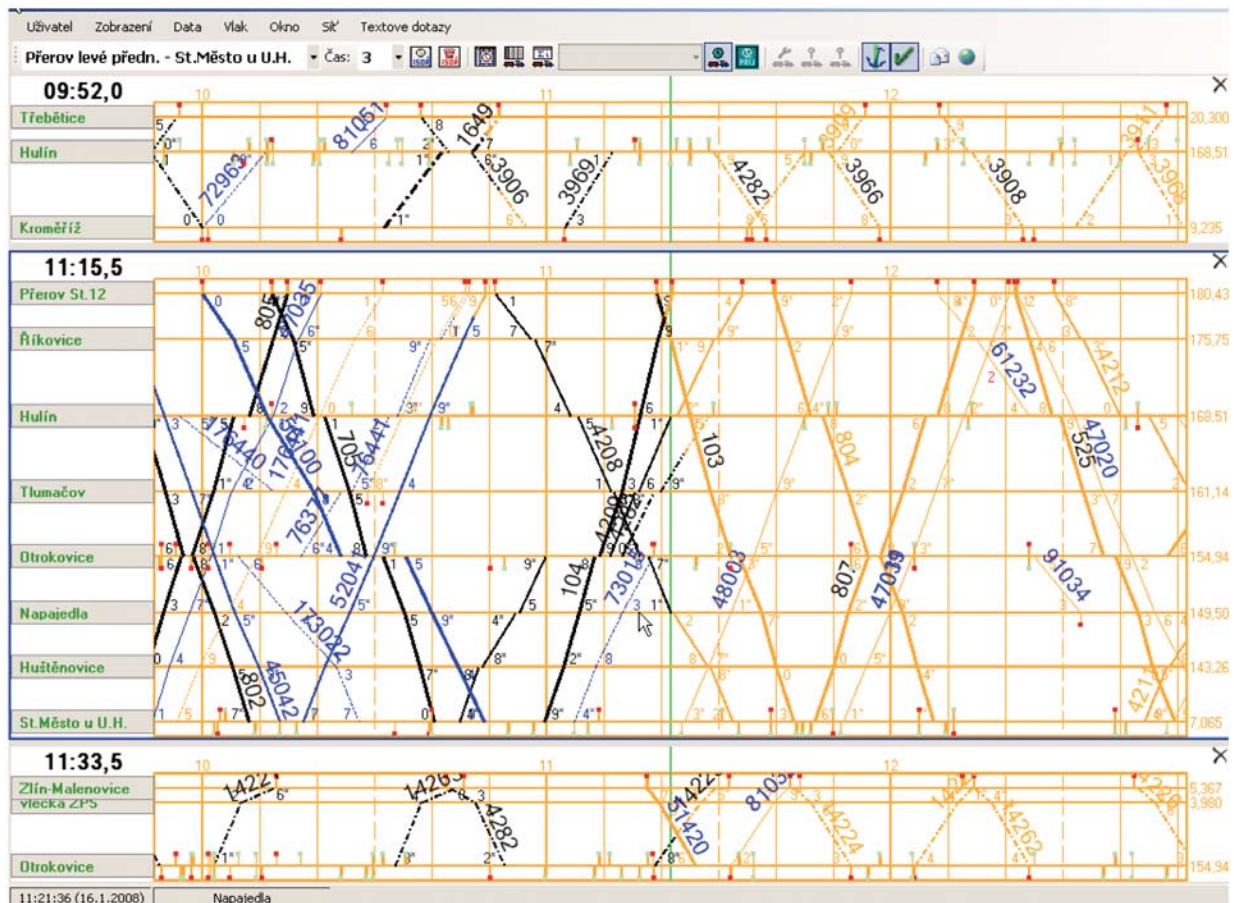

Fig. 2 Displaying the main and side tracks in the controlled area of Breclav - Prerov

the controlled area. Therefore, another extension of the GTN possibilities in the Czech and Slovak Railways environments was to interconnect the system with the all-state railway network information systems for freight and passenger transport (ISOR, CDS, PIS, EDD). This enables us to gain information on the train and its run from the moment it has been planned to the arrival at the controlled area. The most important information are as follow:

- information whether a particular train operates today which we react to by installing it into perspective traffic. This applies mainly to freight transport; with passenger transportation we prefer to refer to the train operation calendar.
- some of the train parameters, such as, e. g. its weight, length, driving vehicle, engine crew, TIN (train identity number) etc.
- current train delay and the station of the latest known train event.
- planned operations on the train in the controlled area (terminating the run, sidetracking the train, renumbering the train and so on).
- anticipated and actual departure time from the station neighbouring with the controlled area.

2.3 Evaluating, retaining and presenting the transportation situation

The acquired data are saved into the traffic data model which is presented to the operation staff in several ways. The basic ones are as follow:

- a two-parts train control diagram displaying following information: fulfilled traffic and perspective traffic, containing its prognosis. Except the train routes locations themselves, to display their attributes we have also used other graphical and interactive means. The individual line segments are defined by operation staff, they can be displayed in different modes, forms and numbers.
- train data record, picturing time information on its run, used rails and some important technological events. The train diagram and train data record contain actual time data compared with the planned ones, it is possible to display the differences.
- summary information on the train, picturing the train technical parameters.
- events protocol for the controlled area capturing all important events in the traffic and the GTN servicing.
- number of internal protocols capturing in detail the GTN system operation, its communication, operation staff activities etc.

Kdy	Vlak	Událost	Dopravna	Druh	Čas/Info/Důvod
17.4.2007 12:40:12	614(1)	Odjezd na Tk 2	Hájek	ZZ	korekce -25 sekund
17.4.2007 12:40:12	614(1)	Odjezd Sk 2	Hájek	ZZ	korekce -25 sekund
17.4.2007 12:40:12	614(1)	Odjezd na Tk 2	Hájek	ZZ	korekce -25 sekund
17.4.2007 12:40:21	614(1)	Uvolnění Sk 2	Hájek	ZZ	-
17.4.2007 12:40:21	-	Vlak/PMD 999901 dojel do Chodov zhlaví celý.	KV - staniční	č.327	-
17.4.2007 12:40:44	17110(1)	Odjezd Sk 2	Karlovy Vary	ZZ	korekce -30 sekund
17.4.2007 12:40:50	17110(1)	Uvolnění Sk 2	Karlovy Vary	ZZ	-
17.4.2007 12:41:09	7057(1)	Minutí vj.náv. na TK 1	Stráž nad Ohří	ZZ	-
17.4.2007 12:41:21	169932(1)	Minutí vj.náv. na TK 2	Perštejn	ZZ	-
17.4.2007 12:41:21	169932(1)	Minutí vj.náv. na TK 2	Perštejn	ZZ	duplicita
17.4.2007 12:41:35	66712(1)	VC Sk 2 Tk 2	Kláštelec nad Ohří	ZZ	-
17.4.2007 12:41:42	7057(1)	Vjezd Sk 2a	Stráž nad Ohří	ZZ	-

Fig. 3 Events protocol in the controlled area of Karlovy Vary

These means enable to display the current situation and, at the same time, to create, administer and show archive information describing the traffic within the elapsed hours and days. The data are transferred into archives gradually, in a certain interval after the train run has finished, or after it has departed from the controlled area. The traffic perspective part, except the possibility of following the routes of actually operating trains in their current time positions, also contains an algorithm for searching conflict transportation situations and their proposed solutions.

The key to the GTN importance is that this system of storing traffic information has been certified for the Czech and Slovak Railways as a full-value way of traffic documentation (so called ELDODO, traffic electronic documentation). Operation staff is thus free from a lot of manual work (keeping a transportation diary, drawing the fulfilled train diagram etc.), and they are able to concentrate entirely on controlling the traffic.

610	Stráž nad Ohří	Hájek	Dalovice	Karlovy Vary
Vjezd	10:43,5	10:52,5	11:03,0	11:10,5
Vjezd	10:45,0	10:54,0	11:04,5	11:12,0
+	+25,5	+25,5	+25,5	+25,5
Kolo	1a	2	2a	2a
Čas.náv.	10:43,5			11:10,5
Jízda	10:57,0			11:12,0
Vjezd	10:56,0			11:13,0
Kolo	1			2
Čas.náv.				11:13,0
Jízda				11:15,5
Vjezd				11:16,5
Kolo				2a
Odjezd	10:52,5	11:01,0	11:07,0	11:13,0
Odjezd	10:59,0	11:06,0	11:10,5	11:16,5
+	+27,5	+25,5	+25,5	+25,5
Ti.kolo	2	2	2	2
Předjíždění odjezd		11:06,0		

Fig. 4 Train data record on the train No 610 – precise description of the train run

2.4 Sending information into other IS

Precise train run data in the controlled area acquired in real time from an electronic interlocking are so called 'attractive infor-

mation'. They serve as input data for many other systems. If they needed to be entered manually, a remarkable part of the GTN system benefit would get lost. That is why we, except working in the entry information, generate automatic outputs, too.

First of all, there are already mentioned ISOR, PIS and EDD systems into which we send detailed information on trains arrivals, departures and crossings (times, used rails, correction message sign, reasons for breaching timetables etc.). The information serve the operation IS, managerial systems (as well as to specifying the fee for using the transportation route), the GVD analysis etc.

We send the information on the train arrival and departure, as well as on the creating of the arrival and departure route in the station into the INISS system, which provides voice and visualizing information for passengers at the stations. The train announcements for passengers thus correspond to the train actual run. Thanks to the traffic situation prognosis in the GTN, passengers get up-to-date and precise information on a train delay, too.

Another system which the GTN communicates bidirectionally with is the ASDEK system for measuring some of the physical entities of the running train. It is so called vehicle diagnostics of a running train by means of the firing indicator, flat wheels indicator, hot bearings indicator etc. The ASDEK system, after the train has passed the check point, sends a resulting diagnostics report on the train to the GTN; the GTN gets back to the ASDEK with the number of the train the report concerns, for further processing and archivation. In case the train has been diagnosed with a defect, the GTN initiates an alarm and displays a warning window with detailed information (the train number, the defect character and extent, the axis number, the train side and others) which the dispatcher has to react to.

The GTN also enables voice services for the connection to the train engine driver. Thanks to the voice communicator, it is possible, directly from the GTN environment, to get connected to the train or other participants. In the Czech Republic, the GTN has been implemented with the IPR-Communicator by the CD-Telematika Company; their communicator communicates in the GSM-R and GSM-P environments.

Except the above stated data links, the GTN enables a direct access to the portals of operation control in the railway intranet

network. Therefore, there is an access to the GVD tools, layoffs IS, freight transport IS - CEVIS/WIC, information boards, ISPR RVD - planning, ISOR CDS - trains timetables-related positions. Another extending element is the possibility to send from the GTN text parametered inquiries on trains (shift plan, train analysis etc.) into the operation control system, so, immediately it gains further detailed information for transportation control. This way, the GTN user has at disposal a great number of information sources for its work, including electronic mail.

Our system architecture is open and modular. Hence, it is possible to create connections to new systems, and to extend the existing ones. What guarantees good possibilities of the GTN system further development is its modern software design and the solution we describe below, in the up-coming parts of the article.

3. Hardware and network architecture and communication

During the existence of the IS GTN the demands on its functionality and usage range have been constantly increasing. From

the original requirement to create a single-purpose application to watch and record transport within a two-to-three stations track section, we have gotten to the current shape of a complex information system for large track sections. That is why the IS GTN has gone through several development stages. They corresponded to the various system architectures the system had been built on in the individual stages. The current architecture is based on a wide analysis of all up-to-now used approaches, on evaluating their positives and negatives, summarising the existing functionalities, as well as on future functionalities estimated on the grounds of experience. The aim has been to create a significantly innovated information system built on integrated modules which would communicate with each other. At the same time, their development is relatively mutually independent, maintaining the communication interfaces functionality.

The architecture is built on distributed applications with a quadruple of efficient central servers. The servers are divided into the main and backup branches, where in case the main branch should fail in any way, the backup branch takes over. One of the two servers is a database server, the other one performs as an

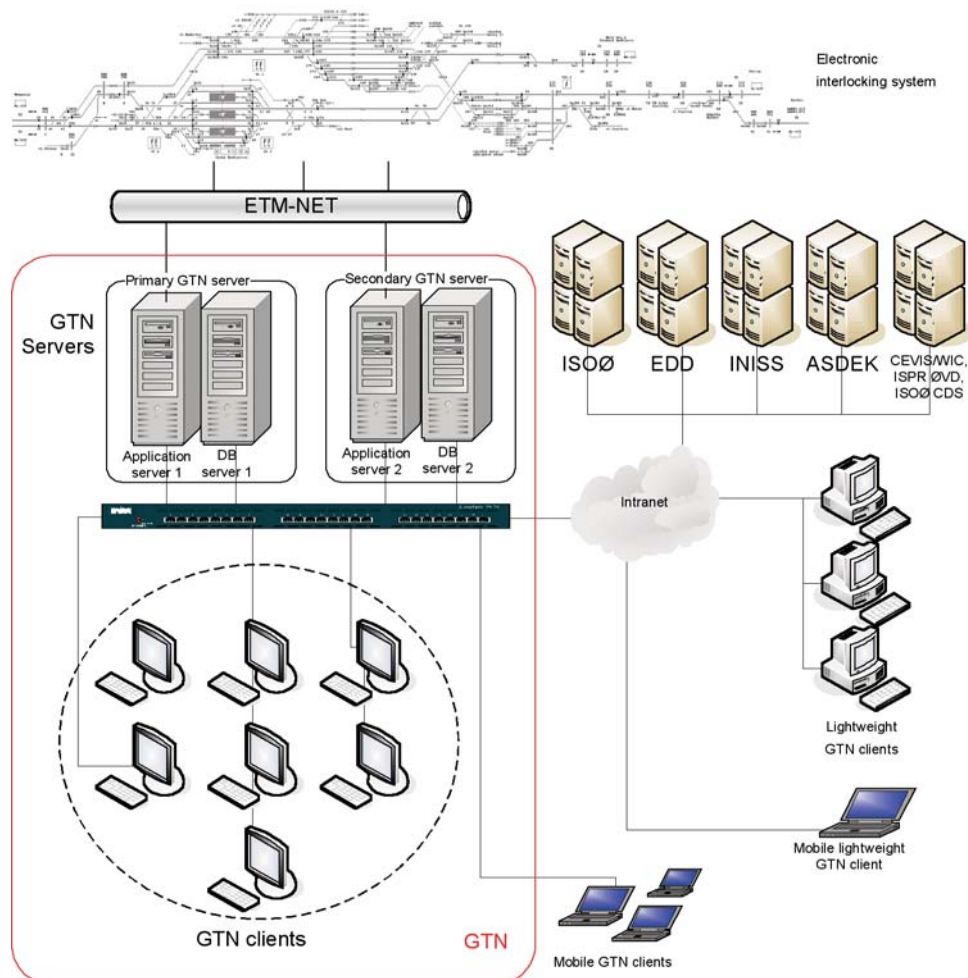

Fig. 5 Architecture of GTN and interconnection to other systems

application server. On the dispatcher's computer the application server's client is running, offering all of the presentation module functions, and containing all of the functions the dispatcher needs to work with the GTN system.

From the viewpoint of communications, the system is based on a fully distributed model. Communication protocols have been designed in such a manner so that they can transmit events and data changes in form of objects. Regardless the event source (train position change, change of state of the signalling equipment element, dispatcher's entry information from an external information system), each event is processed by a relevant module and it is transformed into a data-change event. Consequently, the event is distributed into each part of the system which the change is relevant to. Thus we have achieved that the data are processed and saved into the database in real time and, at the same time, every change is immediately reflected in all the modules, whether it is a part of application server or dispatcher's client. It all results in a dynamic system actually working in real time. The information on the traffic and signalling equipment elements state are permanently at the dispatcher's disposal. As soon as the values of the data displayed in tens of windows at various worksites change they are instantly updated.

From the viewpoint of functionality, the whole system consists of three main modules as introduced below. Each of them has a specific internal architecture, depending on the module application logics.

3.1 Module of communication with the EZZ

The module is supposed to provide communication between the signalling equipment and other parts of the system. The essential thing is to have managed communication protocols and formats conversions. The module core consists of complicated algorithms, which, on the grounds of the current state of train numbers stack, elements, signalling equipment operating personnel's commands and up-to-now traffic progression, determine the individual train-run events. The information get to the rest of the parts of the system in a form which has been within the framework of the system standardized into a communication interface.

The module is the only one which gets in direct contact with the electronic signalling equipment (EZZ). All of the EZZ specifics are closed in the module. This enables the whole system to be relatively independent on the type of electronic signalling equipment. In case the EZZ changes in any way or develops or is replaced completely, it is sufficient to readjust the module, while the rest of the GTN system parts remain fully functional.

3.2 Traffic electronic documentation module

The transportation electronic documentation (ELDODO), as it has been mentioned already, constitutes one of the main functionalities of the entire system. It consists of several components

which the operating personnel will deal with mainly when presenting the transportation situation mentioned in Part 2.3. Detailed information are saved in the database in various forms :

- Trains data. In the system each train is represented by a data object which collects data about the train's planned route, the train's actual operation and movement, and about the operations carried out on the train. It is possible to display the information in a graphic form in a train diagram, in the text train data record collecting information on the train run, or in the train parameters window.
- Operating activities protocol which stores information on the dispatcher's interventions into the signalling equipment or GTN, and on the manner in which they have been worked into the trains data.
- Data about the communication with external IS which inform about the information received from and sent to external information systems.
- Internal protocols which record information on the system state and its activities that influence the system's behaviour, help solve unexpected states afterwards and harmonize the whole system's performance.

3.3 Module of communication with external IS

The module is responsible for mutual communication with external information systems of the operation control, which the GTN takes information from or which the GTN sends information to. The module consists of several smaller modules created individually for each type of an external IS. The sub-modules differ from each other by the communication interface specifics, by the transmitted data formats and structures, and by the ways the data are worked in. Currently, there are following sub-modules:

- Communication with the operation control information systems ISOR, CDS and PIS.
- Communication with the station dispatcher's system EDD.
- Communication with the INISS, which is a system for station automatized train arrivals and departures voice announcements for passengers.
- Communication with the ASDEK system which is a track system for contactless monitoring of bearings temperature, wheel rims, circular brakes discs and irregularities on the wheels perimeters at the moment of the train passing by the device.

The ISOR, CDS, PIS and EDD systems are communicated with on the basis of telegrams of precisely defined formats which are used by several applications utilized by CD and ZSR. The INISS system is communicated with by means of WebServices and the SOAP. A specific communication protocol has been designed and implemented for the ASDEK system.

4. Software and databasis solution

The growing demands on the system functionality have been reflected also in the system software implementation itself. The current version needed to solve several essential, and, to certain

extent contradictory, requirements, which did not play a crucial role when the first versions had been designed. They are simplicity and transparency of the system, large scope of the controlled area, and data basis standardization. All of the demands have been interconnected very closely, and solving one of them has an impact on solving the others.

The goal was to create an architecture which would, in as an optimal way as possible, sort out the requirements placed on the system, and which, at the same time, would not be too complicated from the viewpoints of technology and logics. The design stems from a standard linear multi-layer architecture consisting of several basic layers:

- Data persistence
- Data access
- Data manager
- Client's and server's application logics

This solution has increased the possibilities of the system's further modification and extension, and it supports its distributivity.

The controlled area range, attachment to other external information systems and the data standardization requirement have been the reason why the IS GTN has moved from its own data-persistence management to using a database system. Yet, the architecture remains independent on the data-persistence system, and it is possible to be replaced by implementing another layer of data access.

The logic layer is responsible for the access to the lowest data-persistence layer. It hides the complexity of the access to the physical data storage from the rest of the layers. The key point of this part is its interface design. The interface helps the system gain the data access, and it should be universal, not too complicated. Its design ought to take into consideration various data-storages systems.

The data manager represents the main core of the system. Its modules ensure creation of serialized data entities which are used with data-transfers between application layers. At the same time the manager also functions as an administrator of data-objects collections, and coordinates the communication between the layers.

The application logic layer implements the IS GTN functionalities, i. e. the server as well as client parts of the system. It implements the interface between the user and the system, as well as between external systems and the IS GTN. Paralelly, it processes these user entries and external events, and generates system's relevant reactions.

5. Reasons to the control centralization, and its advantages

Railway traffic management depends on the range, punctuality and timeliness of the required information transfer. As long as

finding, collecting and processing the information are dependent on a human factor exclusively, they are limited by its abilities. This brings along a high number of employees participating in the controlling process, and low effectivity of their activities. Therefore, in order to improve the quality of railway traffic control, it is necessary to use better ways of processing and utilizing the information flows, to employ modern means of communication, securing and information technologies.

Railway transportation control originates from the way the signalling equipment is operated. The device type determines how work is organized with the operation running itself. The ways of work are very different, and they have a significant influence on the railway traffic safety. It is an advantage to have good knowledge of the whole route/track section. This requires the employee-in-charge to have a good overview of the situation, which cannot be ensured by the individual station dispatchers. The need of controlling larger technological area units comes along also with the trains speed on the track, namely on the tracks serving different types of trains with remarkably different ride speeds.

The railway traffic remote control requires to create a workplace where all necessary technologies have to be concentrated. It is appropriate to place the employees in charge of neighbouring sections, or of one technological unit, into one control site (central dispatcher workplace - CDP), which will provide perfect overview of the traffic situation on the individual tracks/routes.

The CDP has been created as a workplace for train traffic remote control in controlled areas. The CDP consists of dispatcher centres for the individual controlled areas. A dispatcher centre constitutes a complex of operating and other workplaces of all function positions of the employees in charge of a given area. They are: operation dispatcher, controlling and section dispatchers (DOZ dispatchers), traffic operators, dispatcher of railway transport route functioning (technical infrastructure). One of the components of a transportation hall might be an overview display of the controlled area on large screening units.

The DOZ dispatchers directly control the traffic within the allocated part of the controlled area, and they remotely control the signalling and interlocking equipment. The number of the DOZ dispatchers on duty may change, depending on the train traffic density. The number of service workplaces of the controlled area signalling equipment has to be relevantly sized to the maximum expected train traffic volume. Various operation personnel combinations and division of the controlled area into the DOZ dispatchers' districts are determined by the service plan. Last but not least, operation employees reduction, namely at the stations, has been a considerable benefit of the control centralization.

The way a long track section is controlled needs to respect also the local operation-technological processes. Among limiting factors, there is an ability of one employee to manage the operation of their allocated area. Further on, the communication connections to another workplaces participating in the controlling process have to be elaborated, especially connections to the station dispatchers

of all of the stations neighbouring with the controlled area. One must not forget about specific demands on the communication equipment. The essential thing is a connection between the DOZ dispatchers, the controlled stations and entry stations, switchable in accordance with the controlled station mode in remote or local operation. Next, there is a need of local radio networks to connect with working teams in the field (shifting, infrastructure maintenance) and the track radio system (GSM-R) to connect with the train engine driver. What is also important is the passengers information system, or the carriage diagnostics system of the trains currently moving on the tracks.

Delegating the control of the individual stations signalling equipment to one central dispatcher workplace represents a breakthrough in the transportation processes effectiveness and quality. Implementing new technologies enables to change the track section controlling technology significantly. The control of train traffic within larger track units, including the single-route, branching or train-creating stations, brings along higher effectivity of the decision-making processes. A model of control like this might include all key transportation elements. To make also the management of large track units as operative as possible, it is necessary to apply correctly the supporting technical and telematic means and transportation technologies. The signalling equipment remote control with a direct connection to the information and management systems of the railway transport enables the ultimate usage of the information flows related to the transport processes management. Therefore, the information and control system GTN has its irreplaceable position in the systems architecture in the area of a track operation.

6. Implementing the remote control on the CDP Prerov for the track Prerov - Breclav

The international corridor track Breclav - Prerov is a pilot project of implementing the latest GTN system version, as well as one of the first central workplaces of remote control.

The centralized control of the track Prerov - Breclav was solved as one controlled area. Since March 2007 the track has been con-

trolled from one CDP dispatcher centre in Prerov. To execute remote management of the signalling and interlocking systems of all fifteen stations they have been using the AZD DOZ 1 system, i. e. remote control with emergency servicing and with backed-up communication branches. The dispatcher commanding computer has been complemented by a range of specific servicing functions related to the control of a large controlled area. They are, e. g., automatic turning of a track approval according to a given train route or building a train route over more stations by one dialing. The transmission of train numbers in the station and track rails relief is commonplace. The signalling equipment control corresponds to the basic technical requirements on the unified active control place. The AZD DOZ 1 remote control is complemented by the GTN application which automatically keeps the transport electronic documentation, displays current and perspective traffic situation, data-communicates with higher information and controlling systems of the railway transport. The GTN provides the access to selected portals of the operation and operative control in the CD intranet. Thus all of the important information are available within one system, either directly or by request.

At all entry stations of the track Prerov - Breclav, terminals for train numbers insertion and their anticipated and actual departures have been installed. Therefore, the mutual data communication has fundamentally minimalized the DOZ dispatchers's voice communication with the employees-in-charge of the entry stations when negotiating the train rides.

A large display of the whole-track trackage is solved in a form of backed-up individual serviceless projector equipment. Four displaying modules with back projection of a 67" diameter and placed into a row next to each other are used. Above them, there are 12 LCD monitors to display subways and platforms from the camera systems. There are more than 80 screening cameras all over the track. The individual pictures are switchable.

The dispatcher centre of the controlled area of Prerov - Breclav is shared by the traffic control dispatchers and transportation operators; the traffic route functioning dispatchers have an independent room.



Fig. 6 View of dispatcher workplace in dispatcher room

The traffic over a 100 kms double-rail track in 15 stations is controlled by two control dispatchers. Three section dispatchers are in charge of local works and operation over 8 sidetrackings. Two operators watch the automatic activities of the passengers information systems and other systems. This is the maximum personnel occupancy. However, there are also variants of lower personnel occupancy, which apply with low traffic volume.

The traffic route functioning dispatcher has at disposal the state diagnostics of the station, track as well as remote signalling and interlocking equipment. Furthermore, they watch the indications of the exchanges electric warming, trackage night lighting, fire alarm, objects securing signalling, platform elevators operation, supplying the traction power lines and signalling equipment. This way, supervizing the track technical systems has been concentrated into one and only workplace.

At four important stations, emergency station dispatchers are based. In case of an emergency they take over. The other stations do not have any transport-controlling staff. However, each station, after it is occupied by a station dispatcher, is possible to control locally.

7. Conclusion

Currently the GTN system has been implemented in more than 50 controlled areas of the Czech and Slovak Railways networks. It serves as an extension of the AZD Praha signalling equipment on nearly 1,800 kms of railway tracks. Except the remotely and centrally controlled tracks, which are described in detail in the above article, it also works on extensive tracks controlled from several stations, on small local tracks, as well as at big nodal stations, such as, e. g., newly reconstructed main station in Prague. The system is supposed to be implemented abroad, too. It needs to be able to react to all differences stemming from the different implementations. Changing and innovating the GTN system is also required due to the need to communicate with more and more new external information systems and further versions of the signalling equipment.

The diversity in the implementation of the system has shown the IS GTN flexibility, and its constant development. This is enabled by its modular architecture, and by using the latest information technologies for its creation. Therefore, GTN represents the combination of a reliable system which, with some tracks, has been working on its own for years, and of a modern application which is able to develop itself and extend the areas of its utilisation permanently.

Abbreviations

ASDEK	- system for measuring some of the physical entities of the running train
CDP	- centralized dispatcher workplace
CDS	- central dispatcher system
CEVIS/WIC	- freight transport IS
CD	- Czech Railways
DOZ	- remote centralized traffic control
EDD	- electronic traffic journal
ELDODO	- traffic electronic documentation
ESA	- electronic interlocking system
EZZ	- electronic signalling equipment
GTN	- the traffic information and controlling system
GVD	- railway traffic plan
INISS	- information system for passengers
ISOR	- the information system of operative management for CD
PIS	- the information system of operative management for ZSR
SENA	- the system for railway traffic planning for CD
TIN	- train identity number
ZONA	- the system for the system for railway traffic planning for ZSR
ZSR	- Slovak Railways

Acknowledgement:

This contribution is the result of the project implementation: **Centre of excellence for systems and services of intelligent transport**, ITMS 26220120028 supported by the Research & Development Operational Programme funded by the ERDF.



"Podporujeme výskumne aktivity na Slovensku/Projekt je spolufinancovaný zo zdrojov EU."

References

- [1] KRSAK, E., BACHRATY, H., TAVAC, V.: *Information System for Railway Control on International Corridor Tracks*, Conference EURNEX-ZEL 2006, pp. 68-73, Zilina ISBN 80-8070-547-X.

- [2] ADAMKO, N., SADLON, L.: *Application of Network Graphs in Simulation Models of Railway Nodes*, Proc. of Intern. conference on informatics technologies in Czech Railways, Infotrans : Pardubice, 2003, ISBN 80-7194-530-7.
- [3] SOTEK, K., BACHRATY, H., KRSAK, E.: *Simulation Model of Railway Traffic*, 36 International Conference MOSIS'02 : Roznov pod Radhostem, 2002, pp. 51–57, ISBN 80-85988-72-0.
- [4] SOTEK, K., CHLAN, A.: *Research Project Theory of Transport Systems*, Proc. of Industrial Simulation Conference 2005, Franhofer IPK : Berlin, pp. 282–285, ISBN 90-77381-18-X.
- [5] POLACH, V.: *Centralised Control Place Prerov - Pilot Project*, In: Conference EURNEX-ZEL 2007, pp. 91–98, Zilina, ISBN 80-8070-249-7.
- [6] TAVAC, M., TAVAC, V.: *MDA Transformation of RDB to OODB*. In: Conference Objects, Ostrava, issued by VSB – Technická univerzita : Ostrava, 2007, pp. 96–106, ISBN 978-80-248-1635-7.
- [7] TAVAC, V.: *Graphic Editor of CD Network Data*, Proc. of intern. symposium on Information technologies in transport in Czech Railways : Pardubice, 2002, ISBN 80-7194-419-X.
- [8] GABOR, M., RUZBARSKY, J.: *ZONA and Timetable for Crews for Railways Vehicle*, Intern. conference Infotrans 2003, Pardubice : Univerzita Pardubice, ISBN 80-7194-530-7.
- [9] HRKUT, P.: *Software Support for Creating Railway Graphical Timetable Documents*, In: International Conference Infotrans, Pardubice, 2005, ISBN 80-7194-792-X.
- [10] HRKUT, P., MATIASKO, K., KRSAK, E., ZABOVSKY, M.: *Information Communication System for an Intelligent Transport System*, Intern. Conference Manazment v zeleznicnej doprave, Zilina, 2005, ISBN 80-8070-456-2.
- [11] URAMOVA, J., BACHRATA, K., KLIMO, M.: *Applying Information Theory to Transport Traffic Modelling*, In: Infotrans 2007 Pardubice : Univerzita Pardubice, pp. 287–294, ISBN 978-80-7194-989-3.

Patrik Hrkut *

ARCHITECTURE OF PROVIDING SERVICES IN INTELLIGENT TRANSPORTATION SYSTEMS USING SEMANTICALLY DEFINED INFORMATION

Intelligent transportation systems (ITS) is an area currently developing very fast. The key to the ITS success will definitely be the implementation of services which would be solving all of the requirements of the road transportation participants. The article proposes the architecture to be used to control the services provided within the intelligent transportation systems. The architecture presupposes using semantically modelled information to be able to find new services in more intelligent way, to preliminarily distinguish unknown services and use them anyway.

1. Introduction

Transportation in the European Union is becoming more and more important component of the economy. Every year more and more passengers and cargo are to be transported. As the Document by the European Committee 'Keep Europe moving - Sustainable mobility for our continent' [1] reads, the volume of cargo transportation grew by 2.8% every year from 1995 to 2004. The passenger transportation growth rate was 1.9%. Between 1995 and 2004, the cargo transportation grew by 28%, and the passenger transportation grew by 18% in total.

These facts say that the growth is regular, and the tendency does not seem to be changing. Unfortunately, the transportation infrastructure is not developing equally quickly. Apart from other consequences, this has also been resulting into a number of car accidents on overly busy roads, with lots of lost human lives and much time wasted in traffic jams. All these facts sum up into huge economic loss and, last but not least, they represent damages to the environment.

It is not easy at all to keep adding up new and new infrastructure, or, eventually, extending the existing infrastructure, and thus heightening its capacity. Solutions like these are economically very demanding, as well as sources are limited (both space and time-wise). One of the possibilities is to involve informatics into the process of solving these problems, and help achieve efficient and intelligent control of the existing transportation and its systems. The intelligent transportation systems (ITS) can organize and manage transportation systems in such way that they can be used as efficiently and economically as possible.

2. Communication in the intelligent transportation systems

Transportation systems are a specific type of systems, namely from the viewpoint of communication networks. It is not possible to fully apply the knowledge and principles used in common computer networks. With computer networks the infrastructure is usually fixed or localized in relatively small geographical locations, whereas in the ITS the networks are geographically vast, and usually they are not even interconnected completely. Moreover, contrary to common networks, where the equipment is usually known in advance (computers, routers, portals etc.) and also the services and their communication protocols are known (WWW - HTTP, VOIP - SIP, E-mail - SMTP, ...), in the transportation systems networks the equipment is considerably different - transportation infrastructure, intelligent signs, parking systems, toll systems, garages, motor-cars etc.

The services the above agents involved are able to provide are diverse (information on navigation, fees, traffic jams on roads, parking vacancies, defined traffic diversions ...). In opposition to traditional networks, the services need not be known in advance. The standards given for this area are only being created, and the question remains to what extent the producers will be willing to implement them, or whether they will rather use their own proprietary systems, which can give them an advantage on the market.

In Europe it is the European Telecommunications Standards Institute (ETSI) that creates standards for the area. Since it deals mainly with the standards for the area of information and communication technologies, most of the standards are oriented to this area also in the ITS. Among the standards (most of which are just being designed) there are standards concerning the commu-

* Patrik Hrkut

Department of Software Technology, Faculty of Management Science and Informatics, University of Zilina, Slovakia,
E-mail: patrik.hrkut@fri.uniza.sk

nication between a vehicle and the infrastructure, such as Dedicated Short-Range Communications (DSRC), Continuous Air Interface Long and Medium Range (CALM), as well as the mutual communication between vehicles themselves [2]. They are standards that prevalingly resolve especially lower levels of communication, but it is also possible to find some standards describing potential applications in the ITS area [3]. What is also promising is the initiative of the motor-car (Audi, Fiat, Opel, Volvo, Volkswagen a others) producers and other companies that have established CAR 2 CAR Communication Consortium [4]. The main aims of the Consortium are as follow:

- developing and pursuing the standards in the ITS area
- creating foundations and specifications for the standards, especially in cooperating with the ETSI,
- contributing to the worldwide harmonisation of the C2C standards,
- supporting the unified implementation of an exclusive communication frequency ,
- creating realistic strategies and business models of the C2C applications implementation,
- demonstrating possibilities and feasibility of the C2C applications.

The architecture this article suggests to use is not proposed to be an alternative to the above standards, it is rather an idea of generalising some of the application protocols so that the interoperability between various participants of communication can become easier, and new services on the same protocol platform of lower levels can be developed and distinguished in more simple way.

3. Services in intelligent transportation systems

The basic categorisation of the ITS services is concentrating on the participants of communication. According to which parties participate in the communication, the services have been divided into two essential categories as follow:

- communication between a vehicle and the infrastructure (Vehicle 2 Infrastructure, V2I),



Fig. 1 Types of communication in the ITS

- communication between vehicles (Vehicle 2 Vehicle, V2V, sometimes also Car 2 Car, C2C).

The communication does not necessarily have to be focussed only on the road transportation participants, but in general all kinds of transportation can communicate with each other. Figure 1 from ETSI website also shows that not just the road infrastructure can serve as the source of information, but it can also be any other device able to provide information in one or both directions (satellite, mobile networks).

The architecture the article presents has been designed in a general way, with no ties to any particular communication type. Its main use can be seen in the mutual communication among vehicles (e.g. the exchange of multi-media files among vehicles), but also in the communication between a vehicle and the infrastructure (e.g. reporting dangerous situations on the road).

As it has been specified in the above part, the standardising process in progress is concentrating mainly on lower communication levels. This is understandable because without the lower level standards, the communication is not possible at all. However, it is equally important to agree on the way the services to be provided in the ITS.. The services are the key to success of the intelligent transportation services. Therefore it is very important that motor-car producers agree on a group of services the devices will support. The unified transmission zone will not guarantee that a vehicle understands every information that gets to it. The architecture proposed hereby tries to solve the following questions:

- how to sort out the communication between the devices, when one of them is offering an unknown service, or a service which the other device does not recognize as it has not been defined precisely,
- how to complement an existing service with a new dimension or property which are not directly supported by the other device,
- how to update the services without having to change the software of all of the devices.

4. Semantic modelling of information

In 2001 the web founder Timothy Berners-Lee expressed his idea of further routing the WWW service on the internet. The web contains a great lot of text and other information that are easy to access for people, but machines (other computers) are not able to categorise or search for them. As the information does not contain any other complementary information or its ties to other information, machines cannot understand and connect mutually related information. Searching is therefore limited just to key words, and other information having semantic ties to the information are not found.

Metainformation supplying to the existing information, or, in other words, to annotating the existing text could be the solution. These processes can be automated to a certain extent, but only the person who arranges the pre-processed text appropriately can supply the information with real meaning.

Several languages have been used to make formal records of the relations among information. The most frequently used ones are RDF, RDF Scheme and OWL. The following chapters describe the languages briefly, in order to introduce the corner-stones of the proposed architecture.

RDF language

The RDF language [5] is intended to represent the information on the sources in the WWW environment. It was originally used to describe metadata, such as author, title, time, licence information etc. The language is also possible to use in applications other than it was originally meant for. The RDF data model is based on triples of elements: subject, predicate and object, which all together create a statement (declaration). The source can serve as the subject or object, and the predicate corresponds to the object attributes that have been observed. The model represents the triple: the subject has an attribute (predicate) of a certain value (object).

There is no defined representation for the RDF. You can use a graph representation, as well as an ordinary text description. The W3C has issued a recommendation for the serialisation based on the XML language, i. e. sequencing the individual statements into elements and attributes of the XML language.

Here is an example of a record in the XML language:

```
<?xml version="1.0"?>
<rdf:RDF xmlns:rdf="http://www.w3.org/1999/02/22-rdf-syntax-ns#"
  xmlns:si="http://www.w3schools.com/rdf/">
<rdf:Description rdf:about="http://ids.fri.uniza.sk/services">
  <si:title>Services in Intelligent Transportation Systems</si:title>
  <si:author>Patrik Hrkút</si:author>
</rdf:Description>
</rdf:RDF>
```

The same example written down in the form of a graph:

RDF Scheme

The RDF language describes sources by means of classes, attributes and values; it needs a tool to describe application-specific classes and attributes. The RDF Scheme is a semantic extension of the RDF, and it provides mechanisms to describe the related sources groups and relations among them. The RDF Scheme data model enables to create data classes. The system of classes and attributes is very similar to the object-oriented languages. A class

is defined as a sources group with identical characteristics. The classes can create hierarchies on the basis of the relations. The RDF Scheme does not provide dictionaries for applications, but it can describe relevant classes and attributes and their mutual relations.

Ontologies

Ontologies represent the core of semantic information modeling. Before the applications are able to understand each other and to recognize information in the data, it is necessary for them to use mutually compatible data descriptions, i. e. to abide with syntactical inter-operability. This way the systems will understand the contents of documents correctly.

The term 'ontology' originates in philosophy, and it denotes a theory of being, of what exists, and what are the relations between the particular elements. Ontologies usually include definitions of classes, relations among them, functions and restrictions. A typical ontology contains a hierarchical description of important notions of a given domain.

In the area of the intelligent transportation services it is possible to create an ontology, and to use it to define a common dictionary to be used by all the participants of the communication in the ITS. It will be necessary to collect all notions and define their mutual relations. Then, on the basis of the collected information, conveniently inter-related on the grounds of their semantic reciprocity, it will be possible to create a source of information on not just the services provided in the ITS but also generally on all terms from this specific area. At the end, it will be necessary to write the information down by means of a formal language. A suitable candidate is the OWL language.

OWL language

The OWL contains more options of describing attributes and classes than the RDF and RDF Scheme do; apart from other things it can describe relations among classes, such as disjunction, equivalence or cardinality. At the same time it contains wider possibilities for the description and characterisation of attributes. The language was designed to be used by the applications which need to process the contents of documents. The OWL guarantees mutual interconnectivity of the contents, and provides good possibilities for describing the relations among information. The OWL has three variants differing from each other by their expressing abilities (in downgoing sequence) - OWL Full, OWL DL and OWL Lite. The OWL DL is the most frequently used one.



Fig. 2 The RDF statement written down in the form of a graph

With its expression rate, the OWL DL draw near the OWL Full, with one difference - a statement evaluation is guaranteed within definite time. The OWL DL supports a set of constructions identical with the one the OWL Full does, with one difference: it does not support free mixing of the RDF and RDF Scheme, and it requires a strict separation of classes, individualities (in the notions of the object-oriented programming, an individuality is understood as a class instance), attributes and values (a class can be a sub-class to other classes, but it cannot be an instance to another class).

5. Design of the architecture to provide the ITS services

As it has been mentioned already, the suggested architecture is aiming at covering various types of services in the ITS. In the area developing as quickly as the ITS is, there will always be new services appearing, or, the existing services will be enriched with new attributes. One of the questions arising here is how to incorporate the new services and attributes into the existing systems without having to upgrade the existing devices in any remarkable way, whether they are devices in vehicles or in road infrastructure. One of the things the suggested architecture is supposed to do is to simplify the creation of new services as much as possible, as well as to simplify their registration and distribution to the devices.

The essence of the architecture is supposed to consist of the ITS area ontology, which should combine all of the substantial notions of the domain. The primary contents of the ontology would consist of:

- vehicles, categorisation and attributes,
- road infrastructure elements,
- services and their characterisations,
- events, car accidents, dangerous situations.

Each newly originated service will be described in detail, categorised and suitably incorporated into the existing ontology. The ontology like this could be distributed (e.g. using distributed databases [6]) in the environment of road infrastructure or over the internet. In case a vehicle gets within the reach of a device providing newer definitions of services, it would automatically update its definitions of services. Of course, other vehicles disposing of the newer ontology version are also able to convey the information, and vice versa, vehicles with the latest ontology version would be spreading it.

It is important to make sure the ontology is possible to be used on the devices in the ITS. It is not possible to expect that the

devices would dispose of a remarkable calculation performance, or of an extensive memory for complicated questioning which has been done over ontologies. To solve this problem, we could use a transformation, e. g. the XSLT, so that we can simplify the information model in such a way that the information can be used for simpler devices. Another potential solution would be implementing a transformation or a simplified query language which would be optimised for the devices with a weaker calculation performance.

The following example will show us what the process might look like in practice: a vehicle is signalling to another vehicles coming from the opposite direction that they are heading towards a road section where there is a dangerous situation. Not all vehicles are able to understand that information exactly, but it is quite enough if they are able to file it into a correct category, and, on the basis of detailed information they have in their ontology, they are able to estimate the type of the received information and its importance, in spite of the fact that they do not recognize it.

Last but not least, it is important to ensure authenticity and unchangeability of the provided information, whether the information comes from a source of the infrastructure or from another vehicle. To solve such problems in practice, we often use the Public Key Infrastructure (PKI), where the information is signed with a private key of the issuer owning a credible certificate of a certification authority. The information receiver may verify the information by the information sender's public key. More information on the PKI implementation can be found in [7].

6. Conclusion

The advantages of the proposed architecture will make it easier to control the existing services, faster to implement new services, more comfortable to incorporate services into the existing systems. The architecture should bring more intelligence into managing the services in the ITS. At the moment, the submitted architecture is being designed, and the selection of the IT area technologies to be used is being finalised. The pilot verification of the proposed architecture is going to take place within the Easyway Project which Slovakia has been participating in.

Acknowledgement:

This contribution is the result of the project implementation: **Centre of excellence for systems and services of intelligent transport**, ITMS 26220120028 supported by the Research & Development Operational Programme funded by the ERDF.



"Podporujeme výskumne aktivity na Slovensku/Projekt je spolufinancovaný zo zdrojov EU."

References

- [1] *Communication from the commission to the council and the european parliament Keep Europe moving - Sustainable mobility for our continent*, Mid-term review of the European Commission's 2001 Transport White Paper. 2006. Brussels. Available from: http://ec.europa.eu/transport/transport_policy_review/doc/2006_transport_policy_review_en.pdf
- [2] *EN 300 674 Road Transport and Traffic Telematics (RTTT); Dedicated Short Range Communication (DSRC) transmission equipment (500 kbit/s / 250 kbit/s) operating in the 5,8 GHz Industrial, Scientific and Medical (ISM) band*. Available from: http://webapp.etsi.org/workprogram/Frame_WorkItemList.asp?SearchPage=TRUE&qETSI_STANDARD_TYPE=&qETSI_NUMBER=300+674
- [3] *ETSI TR 102 638 Intelligent Transport Systems (ITS); Vehicular Communications; Basic Set of Applications; Definitions*. Available from: http://pda.etsi.org/pda/home.asp?wki_id=E-GA9-A_UJ46C974vO.qm
- [4] *Car 2*. Car Consortium, Main page, <http://www.car-to-car.org/>
- [5] *RDF Primer*, W3C Recommendation. Available from: <http://www.w3.org/TR/2004/REC-rdf-primer-20040210/>
- [6] JANECH, J., BACA, T.: Distributed Database Systems in Vehicular Ad-hoc Network, In: *Communications - Scientific Letters of the University of Zilina*, No. 1, 2010, ISSN 1335-4205.
- [7] KRSAK, E., MARTINCOVA, P.: *Digital Signature Implementation in Educational Institutions*, Intern. conference on Information Technologies (InfoTech-20009), 2009, Varna, Bulgaria. In: Proc. of the 23rd International Conference on Systems for Automation of Engineering and Research (SAER-2009), Sofia : State Agency for Information Technology and Communication : Technical University of Sofia, 2009. - ISBN 978-954-439-771-6, pp. 60-67.

Juraj Micek – Ondrej Karpis *

WIRELESS SENSOR NETWORKS FOR ROAD TRAFFIC MONITORING

The paper presents an analysis of communication technologies that should lead to choosing technology appropriate for road traffic monitoring. One of the best available communication technologies is standard ZigBee. Experimental measurements of data rate with respect to distance under different operating conditions are presented. Based on obtained results it is possible to say that using ZigBee technology in wireless sensor networks is appropriate if we expect lower data rates (70 kbps).

1. Introduction

Wireless sensor networks (WSN) represent new technology for effective solving of tasks that include distributed information sources. According to [2] contemporary applications of sensor networks can be divided into four basic groups:

Environmental and habitat monitoring. Nowadays mankind stands in front of many unsolved environmental issues that can drastically influence quality of life in the future. The monitoring of changing parameters of environment is one of the first tasks on the way to reduce undesirable effects. Collection and processing of huge amount of data is possible using well organized WSN network. WSN networks can essentially contribute to improving long-term weather and climate change prediction.

Medical diagnostics and health care. Wireless sensor network technology is ideal for monitoring health conditions of patients and elderly people. Interesting practical application of WSN in health care monitoring is described in [5]. Example of monitoring vehicle drivers to determine their ability to drive can be found in [4].

Military surveillance and industry security. Due to its intensive nature, distributed wireless sensor networks are suitable to monitoring military strength, equipment and material. Wireless network is part of "Smart Dust" technology that is based on large amount of tiny wireless microelectromechanical sensors that could be spread over a large battlefield area, monitoring enemy movements and detecting everything from light to vibrations in a covert manner, [6], [7]. WSN are often used to improve security in some dangerous industry environments such as mines and nuclear power stations.

Industry applications. Wireless sensor networks can be found in factories in technology processes monitoring, safety systems

and others. Nowadays WSN are used more and more in control systems.

WSN could be characterized by following features:

Large-scale networks consisting of huge amount of sensors arranged in space with defined granularity. Using distribution management system methods to execute complex and large numbers of data could increase monitoring accuracy (signal-to-noise ratio is increased) and decrease accuracy requirement of each nodes. The existence of the redundant node can improve the lifetime of the whole wireless sensor network and provides the system with strong capacity of fault tolerance. A high density of sensor nodes enables increased monitoring coverage and provides chances to eliminate caves or fade zone.

Self-organizing networks make it possible to place nodes without preexistent infrastructure. Individual sensor nodes can be scattered randomly while respecting their communication range. After arranging, nodes are able to create functional network. In the case of node failure or energy blackout the network topology is dynamically changed. Likewise new nodes can be added on the fly. This could prolong the networks' lifetime and greatly improve their performance.

Multi-hop routing is used to allow communication between any two nodes whose separation is larger than maximum communication distance (usually few hundred meters). In such a case intermediate nodes have function of repeaters. This area is continually improved using new, interesting methods of routing.

Besides mentioned three basic properties wireless sensor networks are characterized by other properties that are described in detail in [2].

* Juraj Micek, Ondrej Karpis

Faculty of Management and Informatics, University of Zilina, Slovakia, E-mail: juraj.micek@fri.uniza.sk

2. Applications of WSN in traffic

One of the most perspective areas of WSN application is traffic. Traffic systems are large-scale with distributed information sources by nature. Traffic systems controlling requires different approaches from those used in classical technology processes controlling. Wireless sensor networks provide effective means for data collecting and transport. This makes from them an inseparable part of intelligent transport systems (ITS). Among the first successful applications of WSN in traffic were systems for monitoring transport flow parameters in order to determine transport intensity, to control crossroads with traffic lights, to forecast trends in traffic and so on.

Developing the WSN is a complex problem with many particular parts: network nodes design, development of effective methods of data preprocessing and methods of reliable communication.

The network node consists of a sensor module, control and signal processing module and RF transceiver, Fig. 1.

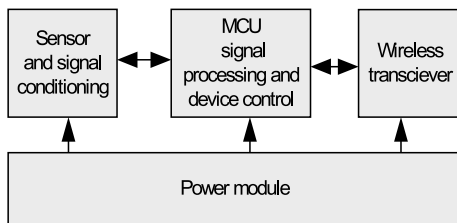

Fig. 1 Wireless network node

Each node must be able:

- to relay wireless data with defined data rate and communication range
- to operate reliably without maintenance
- to provide qualities required from dynamic ad-hoc mesh communication network.

To satisfy the presented requirements is often an unsolvable problem. Increasing of communication range and data rate dramatically influence energy consumption and lower device lifetime. Therefore, in most cases it is necessary to make compromise bet-

ween energy consumption and data rate or communication range. From this point of view one of the most important decisions is to choose an appropriate communication standard.

3. Communication subsystem

If we don't take into consideration the frequency band defined by standard 802.11.p then there is no dedicated frequency band for wireless sensor networks. The only chance is to use some of the free ISM (Industrial, Scientific and Medical) frequency bands. In EU we can use one of the following ISM/SRD (Short Range Devices) bands: 40.66 - 40.70 MHz, 433.05 - 434.79 MHz, 863 - 870 MHz (SRD), 2.400 - 2.500 GHz, 5.725 - 5.925 GHz, 24.0 - 24.25 GHz, 59.3 - 62.0 GHz, 122.02 - 123.0 GHz (SRD), 244.0 - 246.0 GHz (SRD). Most frequently used is ISM band 2.400 - 2.500 GHz. This band is used by several communication systems that can influence each other (Table 1).

Wireless sensor networks belong to the group of networks known as WPAN (Wireless Personal Area Network). According to data rate are WPAN networks divided into following groups:

HR WPAN (High Rate) - high-speed networks used mainly for RT and multimedia applications. Defined by standard IEEE 802.15.3 with maximum data rate of 55 Mbps or by standard UWB 802.15.3a with speed up to 110 Mbps within range of 10 m.

MR WPAN (Medium Rate) - networks with medium throughput rate used as replacement of cables in consumer electronics. According to standard IEEE 802.15.1 Bluetooth the data rate originally was only 1 Mbps, nowadays it is up to 3 Mbps (standard SIG 2004).

LR WPAN (Low Rate) - low-speed networks dedicated to wireless sensor systems and other simple applications. A typical representative of standards in this group is 802.15.4 IEEE 2003 and 2006 with data rate up to 250 kbps.

Acronym LR WPAN represents a low-speed personal data network. It is a cheap, low power communication network that is intended for applications with a limited communication range, data rate and energy consumption.

Wireless technologies used in frequency band ISM 2.4 GHz (2.4000 - 2.4835)

Table 1

Technology/ interference source	Modulation	Frequency [MHz]	Channel number	Channel width [MHz]	Channel spacing [MHz]
Wi-Fi, 802.11.b	DSSS	2.412-2.472	13	22	5
Bluetooth, 802.15.1	FHSS	2.402-2.480	79	1	1
LR WPAN 802.15.4	DSSS	2.405-2.480	16	3	5
Wireless USB	DSSS	2.402-2,479	78	1	1
Cordless phones	Different	2.400-2.483	Different	Different	Different
Microwave ovens	Impulse	2.400-2.500	-	-	-

Some of the basic properties of LR WPAN are:

- Data rate of 250 kb/s, 40kb/s or 20 kb/s,
- Short 16-bit or extended 64-bit addressing,
- Channel accessing using CSMA-CA, (Carrier Sense Multiple Access with Collision Avoidance),
- 16 communication channels in 2.45 GHz band, 10 channels in 915 MHz band and 1 channel in 868 MHz band.

Standard 802.15.4 defines properties, characteristics and parameters of two lowest layers of ISO/OSI communication model. The link layer is reduced to a medium access control (MAC) sub-layer.

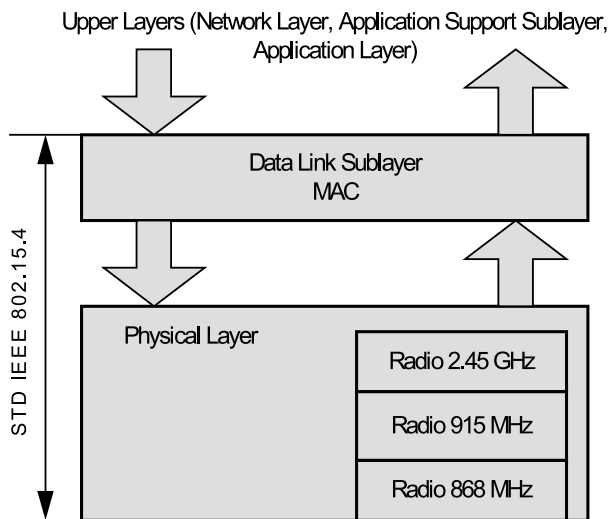

Fig. 2 Structure of standard IEEE 802.15.4

The communication system defined by standard 802.15.4 can operate in three ISM frequency bands. Transfer parameters used in individual frequency bands are summarized in table 2.

Physical layer parameters

Table 2

Frequency band	Frequency range	Channel number	Maximum transfer speed	Modulation	Region
868 MHz	868-868.6 MHz	1	20 kb/s	DSSS w. BPSK	Europe
915 MHz	902-923 MHz	10	40 kb/s	DSSS w. BPSK	USA, Australia
2.4 GHz	2.4-2.4835 GHz	16	250 kb/s	DSSS w. O-QPSK	other countries

Maximum transmit power must obey regulations defined by individual countries. Approximate values of maximum transmit power are shown in table 3.

Maximum allowed transmit power

Table 3

Frequency band	Region	Max. transmit power	Regulation nr.
2.4 GHz	Japan	10 mW/MHz	ARIB STD-T66, B14
	Europe	100 mW EIRP	ETSI EN 30 328
	USA	1000 mW	15.247 FCC CFR47,B14
	Canada	1000 mW	GL-36, B15
902-928 MHz	USA	1000 mW	15.247 FCC CFR47, B14
868 MHz	Europe	25 mW	ETSI EN 30 220, B10

Standard 802.15.4 defines 27 communication channels in three frequency bands. Their numbering and center frequency, F_c are as follows:

$$F_c = 868.3 \text{ MHz for channel } k = 0,$$

$$F_c = 906 + 2(k-1) \text{ MHz for channels } k = 1, 2, \dots, 10,$$

$$F_c = 2405 + 5(k-11) \text{ MHz for channels } k = 11, 12, \dots, 26.$$

Frequency band 2.45 GHz is used by several wireless transfer systems. In this band one can expect the biggest interferences caused by Wi-Fi technologies (standard 802.11) that are presently used in a large scale for data transfer. The assigning of transfer channels in frequency band 2.45 GHz according to standards 802.11 and 802.15.4 is depicted in Fig. 3. The fact that standard 802.15.4 defines only two lowest layers of transfer system allowed creation of different data transfer systems that are used in various applications. Let's mention three mostly used technologies for area of industrial automation: Wireless HART, SP 100.11 and ZigBee. ZigBee technology is the most popular.

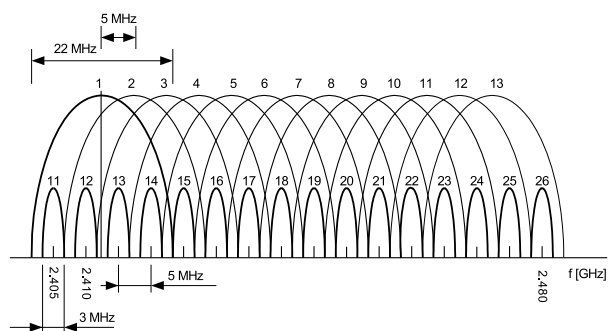

Fig. 3 Transfer channels according to STD 802.11 and 802.15.4

Communication standard ZigBee is designed especially for building automation, wireless telemetry, industrial automation, consumer electronics and other applications with low demands for data transfer rate. Development of this standard was started in 2002 by ZigBee alliance. By the end of year 2004 version 1.0 was finished as extension of physical and MAC layers of standard 802.15.4.

There are two types of devices that can act as communication nodes of ZigBee network:

- Reduced functionality devices (RFD) - relatively simple devices with low memory capacity, limited performance and low energy consumption. They are used as end devices in the network. They lack features such as routing and/or coordinating.
- Full functionality devices (FFD) - more complicated devices whose hardware and software enables implementation of more sophisticated functionalities. They can take the role of router, coordinator and/or end device.

Basic types of ZigBee network nodes are:

- Coordinator, or PAN coordinator, establishes the network, assigns addresses, stores security keys and so on. There can be only one coordinator in each network. It is FFD type of device.
- Routers act as intermediate nodes, relaying data from other devices. Router must be able to establish and control relations between other nodes. Router is FFD device.
- ZigBee Trust Center (ZTC) is a main security element in the network. It provides services related to security and message confidence.
- End devices have sufficient functionality to talk to their parents (either the coordinator or a router) and cannot relay data from other devices. This reduced functionality allows for the potential to reduce their cost. It can be RFD or FFD device.
- ZigBee gateway allows interconnection of ZigBee network with other networks. Its main function is to converse communication protocols.

Number and types of devices used in particular ZigBee network depends upon its scale, complexity and application requirements. Network layer of ZigBee supports these network topologies: tree, mesh and star. Network securing, interconnection with other networks, multi-hop routing algorithms and other additional properties are not mandatory for ZigBee networks. This is a reason why we can see in praxis networks ranging from most simple ones (with only one FFD as coordinator and some RFD's) to complicated, well secured networks designed for industrial applications.

ZigBee alliance released new specification for wireless communication named ZigBee PRO in the year 2007. This standard has following improvements over the previous version:

- enhancements in the area of addressing and routing such as: random address assigning with collision detection, limited broadcasting, using AODV (ad-hoc on-demand distance vector) routing with possibility for many-to-one communication.
- Communication channel change. Interference with other communication systems in ISM band can severely reduce network throughput. ZigBee PRO uses a frequency agility method which allows the coordinator to adaptively change used channels in order to minimize influence of interference on network throughput.
- Power management of end devices allows sleep periods with a maximum period of 7.5 s. Routers are able to remember messages addressed to "sleeping" devices so there is no data loss during a sleep period.
- Securing of data transfer is accomplished by symmetrical encryption AES 128. ZigBee PRO network should have one trust center that provides security services to all other network devices.

ZigBee PRO standard has substantially better properties over ZigBee standard in the fields of data rate, security and robustness especially in the case of large scale communication networks.

ZigBee technology was chosen as a key part of experimental wireless sensor network for monitoring traffic parameters.

4. Experimental verification of XbeePro nodes properties

OEM RF modules developed according to standard 802.15.4 are marked as Xbee and XbeePro. These modules allow rapid development of wireless sensor networks. Modules are able to operate in ZigBee Mesh communication networks. In order to verify properties of modules we realized following three experiments.

Two experiments were realized in full traffic in the middle of day. The first experiment was focused on the influence of antenna type on a data rate. The modules used maximal power output (North American version). In the second experiment we examined the influence of modules placement on a data rate. The placement of receiver (point o) and transmitter is depicted in Fig. 4. First two experiments took place in the centre of Prievidza.



Fig. 4 Transmitter and receiver placement

There were 5 available Wi-Fi networks in 2.4 GHz band at the place of receiver during measurements. Four of them had a low level of signal (1/5 - 2/5) and one had high level of signal (4/5).

The third experiment was focused on comparison of the antenna type on a data rate under almost ideal circumstances - outside the town, direct line of sight, none Wi-Fi networks. Second and third experiments were carried out with modules set to comply with European norms (maximum transmitter power output 10 dBm).

All the experiments were based on a simplex operation of modules. The maximal data rate under ideal circumstances is about 76 kbps. For duplex communication the data rate is halved. The term "data rate" means the rate of transfer of useful data.

Experiment 1 - influence of antenna type on data rate in urban area

Parameters:

- Transmitter output power: 18 dBm (63 mW)
- Wire antenna of length 2.8 cm or ceramic antenna
- Length of measurements: 10 s
- Receiver placed 50 cm above ground
- Transmitter placed 120 cm above ground

Different antenna types in urban area

Table 4

Measurement	1	2	3	3a	3b	4	5	6	7	8	9	10	11	12	13	14
Distance [m]	54	214	300	381	383	305	207	165	60	55	119	203	245	144	91	51
Wire antenna [kbps]	75.2	67	25.3	18	2.6	47.2	42.8	59.2	75	73.9	41	32.3	11.1	50.2	37.9	67.4
Ceramic antenna [kbps]	52	55.8	2.6	0	0	20.3	44.3	37	71	68.4	13.3	11.9	6.4	4.2	9.6	53.6

The ceramic antenna was in vertical position during measurements because of its better performance over horizontal position. The influence of antenna placement depends on the distance of modules and ambient circumstances.

Practically in all the measurements the wire antenna shows a better performance. The data rate for distances under 60 m is close to maximal. In special cases (no obstacles) the data rate remains quite high even for greater distances (see measurement 2).

Experiment 2 - influence of modules placement on data rate in urban area

Parameters:

- Transmitter output power: 10 dBm (10 mW)
- Wire antenna of length 2.8 cm
- Length of measurements: 20 s
- Receiver placed 50 cm above ground
- Transmitter placed 120 cm above ground (placement 1) or direct on ground (placement 2)

The placement of modules has a significant impact on the data rate. If the transmitter was placed direct on ground, the data rate often was reduced below half of a normal data rate. However, the influence of ambient circumstances sometimes allows a higher data rate (measurements 2 and 3). Comparing tables 4 and 5 (rows "Wire antenna" and "Placement 1") one can see negative influence of the lowered transmitter output power on the obtained data rate especially at greater distances. For short distances (about 60 m) the data rate is usually about 10 % lower.

Experiment 3 - data rate under almost ideal circumstances

Parameters:

- Transmitter output power: 10 dBm (10 mW)

- Wire antenna of length 2.8 cm or ceramic antenna
- Length of measurements: 20 s
- Transmitter and receiver placed at least 120 cm above ground

The result of this experiment is similar to the first experiment. It confirms that the wire antenna has a better range than the ceramic antenna. The difference is about 130 m if we define the lowest usable data rate to be 2 kbps.

5. Conclusion and future work

The paper addresses the problem of wireless sensor networks in traffic monitoring. It is focused on choosing proper communication technology, which satisfies basic requirements. One suitable technology is standard ZigBee. The results of experiments in an urban area show that the communication range of modules is quite dependent on modules placement, antenna type and ambient circumstances. For a good modules placement with the wire antenna it is possible to obtain data rates of about 67 kbps for distances of at least 60 m. For lower data rates the distance can be extended beyond 200 m. According to acquired data we can say that ZigBee technology is suitable for WSN applications in transport systems. In the next phase we will focus on developing network nodes capable of sensing acoustic signals, vibrations and with optical distance sensor. The network will be used for the monitoring of transport flows in real world.

Acknowledgement:

This contribution is the result of the project implementation: **Centre of excellence for systems and services of intelligent transport**, ITMS 26220120028 supported by the Research & Development Operational Programme funded by the ERDF.

Influence of modules placement

Table 5

Measurement	1	2	3	3a	3b	4	5	6	7	8	9	10	11	12	13	14
Distance [m]	54	214	300	381	383	305	207	165	60	55	119	203	245	144	91	51
Placement 1 [kbps]	74.6	23.6	5.6	0	0	31.2	35.5	54.6	66.8	67.7	4.1	2.6	1.1	28.7	38.8	72.6
Placement 2 [kbps]	30.3	25.8	6.1	0	0	0.6	10.2	21.9	45.7	21.8	1.5	0	0	0.4	34.3	39.1

Data rate vs. antenna type

Table 6

Distance [m]	100	120	140	160	180	200	220	240	260	280	300	320	340	360	380
Wire antenna [kbps]	74.3	74.7	74.9	76.8	74.3	71.9	63.9	74.5	52	71.5	25.4	17.3	31.7	12.5	0.8
Ceramic antenna [kbps]	74.6	74	73.6	59.1	72.2	32.4	14.3	2	0.2	0	0	0	0	0	0



Agentúra
Ministerstva školstva, vedy, výskumu a športu SR
pre štrukturálne fondy EÚ

"Podporujeme výskumne aktivity na Slovensku/Projekt je spolufinancovaný zo zdrojov EÚ."

References

- [1] HERMS, A., NETT, E., SCHEMMER, S.: *Real-time Mesh Networks for Industrial Applications*, Proc. of the 17th Congress IFAC, Korea, 2008.
- [2] HUANG, M.: Visualization of Urban Transportation Data Generated by Wireless Sensor Network Using Modern Approaches, *Modern Applied Science*, Vol. 3, No. 6, 2009.
- [3] KOVAR, O., MICEK, J.: *Wireless Networks in Automation Equipment*, Proc. of workshop ARTEP2009, Stara Lesna, 2009.
- [4] FORDOS, G. et al.: Sensor-net for Monitoring Vital Parameters of Vehicle Drivers, *Acta Polytechnica Hungarica*, Vol. 4, No. 4, 2007.
- [5] VIRONE, G. et al.: *An Advanced Wireless Sensor Network for Health Monitoring*, <http://www.es.virginia.edu/paper/d2h206-health.pdf>
- [6] ARIEF, B., BLYTHE, P., TULLY, A.: *Using Smart Dust in Transport Domain*, Position paper, UbiComp Grand Challenge Workshop, London, 2009.
- [7] Arief, B. et al.: *Integrating Smartdust into Intelligent Transportation Systems*, Proc. of the 10th Intern. conference AATT2008, Athens, 2008.

Stefan Badura – Anton Lieskovsky *

INTELLIGENT TRAFFIC SYSTEM: COOPERATION OF MANET AND IMAGE PROCESSING

This paper presents a model for intelligent traffic system. Proposed methods describe ideas of information computing from images and its distribution to different nodes in traffic system. Two algorithms for foreground extraction forwarded by classification of extracted objects are discussed in the paper. These approaches serve as a basis for information computing. Communication framework over MANET is presented for efficient information delivery. Appropriate protocol is designed at first, and then some algorithms for efficient data delivery are discussed.

1. Introduction

The objective of this paper is to provide a view on an intelligent traffic system. It consists of information computing from images and distribution of this information to other nodes in the traffic network. Such system can be used in areas of safety transportation, reliability, cost reduction of transport etc. In the first part a possibility of obtaining suitable information is analyzed. In the second part a framework for efficient data delivery (how the message looks like, what the context is, etc.) is proposed. A possibility of integrating these different parts into one common system is also analyzed. The type of information, which is computed in the first part, depends mostly on the system deployment, but its general character could be:

- *Surveillance and security* – the protection of objects from accidents, vehicle crashes, pedestrian injuries, or just monitoring a region of interest (ROI) from unauthorized access. A situation which could be solved is, for example, the monitoring of rail crossing [1], entrances into companies etc.
- *Monitoring systems* – providing early information about current traffic situation (traffic jams, weather conditions, etc).

The process of information computing is based on image processing. Inputs are obtained from a camera positioned in a hover view (light pool). The camera is focused on ROI in which an action occurs).

Images or video sequences are processed with our system (software demo) and the result provides valuable information about the state of system in the given ROI. These procedures can be generalized as a task of *foreground extraction*. The information obtained from the image processing part needs to be delivered to the final customer and it should be accomplished in an effective way. For this purpose the communication framework for a mobile ad-hoc network is designed. The protocol satisfying all the necessary require-

ments for efficient data delivery (size, effectiveness, universality, etc.) is introduced.

Generalization can be made as follows: information is computed from a video sequence (type of information depends on the system deployment, for example: “alert → there is an object on railway crossing”). This data is encapsulated into the message and then it is distributed over a mobile ad-hoc network (MANET). Each receiving node initializes a decision process based on the importance of a received information (see Fig. 1).

In the second chapter of this work a system for foreground extraction is described. Two different methods are analyzed. The first method is a background modeling and the second one is a key point detector. The results from classification process are summarized in the third chapter. The 4th chapter proposes a protocol for information exchange between all the objects of C2X¹⁾ system. In the last chapter some important points for communication establishing and maintaining are outlined.

2. Foreground Extraction

Extraction of foreground objects is a fundamental task in the image processing (to distinguish object from a scene). If this is accomplished with a sufficient result, object recognition and classification, event detection could be performed. There are different methods. An overview can be found in [2], some of them work with one video frame – known are point detectors like SIFT [3], SURF (Speed-UP Robust Features) [4], or Moravec and Harris detectors. Other methods utilize a sequence of images to model background – Eigenbackground, Mixture of Gaussians [5], Background comparison etc. Generally all approaches need to cope with:

- Light and weather changes.
- Noise caused by trees, grass.

* Stefan Badura, Anton Lieskovsky

Faculty of Management Science and Informatics, University of Zilina, Slovakia, E-mail: Stefan.Badura@fri.uniza.sk

¹⁾ Car to Car. Car to Infrastructure

- Permanent changes in background (new car in parking), etc.

The SURF which will be discussed first is an invariant key point detector. We will estimate some key points that could represent the foreground. Next, we will discuss some methods for background modeling.

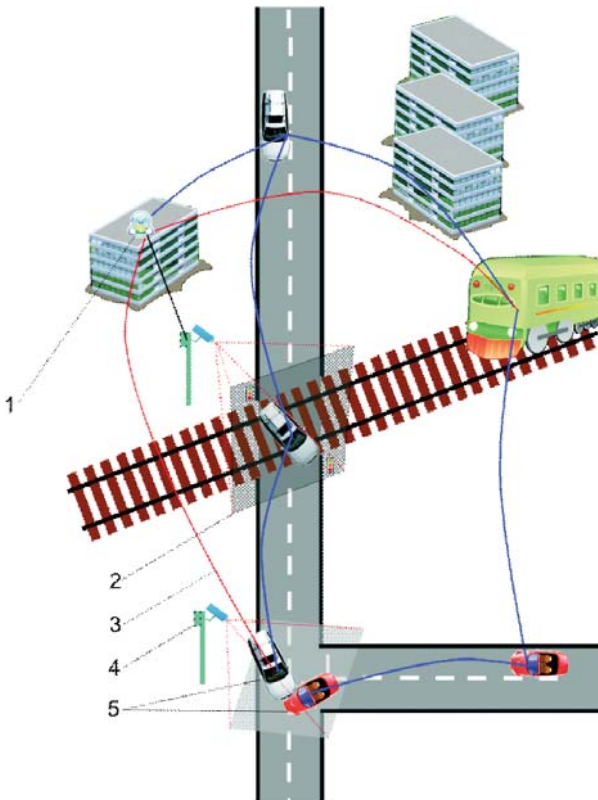

Fig. 1 Design of system deployment.

- 1 - Computational center (image processing).
- 2 - Possible representation of ROI. 3 - Communication between objects.
- 4 - Camera focused on affected ROI. 5 - Objects participated in communication

Invariant Key Point Detector

The SURF is a robust invariant key point detector. It is used for foreground extraction and its description with a set of feature vectors.

The algorithm is a three-step process:

1. Detection and localization of interest points.
2. Construction of feature vector - descriptor.
3. Descriptors matching.

We utilize just first step in our work - *interest point detection* and *localization*. This satisfies the problem of foreground extraction.

²⁾ All the algorithms were tested on a dataset which was captured from the entrance to a company. ROI covered an area where vehicles and persons passed. In the region there was also a barrier which brought noise into the system, therefore, our methods are adapted to this specific problem.

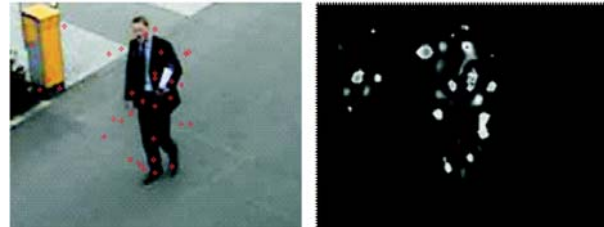

Fig. 2 Left image represents results from invariant key point detector (red circles are detected key points). Right image is an example of detected maxims in determinant matrix.

Detected interest points are considered as candidates for foreground.

If this method is applied on the surveillance system, the following consideration can be made: if the number of detected interest points is increasing, there is probably an object in the scene. This process uses Fast - Hessian features detector and it is based on determinant $D(H)$ of Hessian matrix $H(f)$. The Hessian matrix is the matrix of partial derivatives of two dimensional function $f(i,j)$ (see eq. 1)[4].

$$H(f) = \begin{bmatrix} \frac{d^2f}{di^2} & \frac{d^2f}{didj} \\ \frac{d^2f}{didj} & \frac{d^2f}{dj^2} \end{bmatrix} \quad \text{Hessian matrix} \quad (1)$$

$$D(H) = \frac{d^2f}{di^2} \cdot \frac{d^2f}{dj^2} - \left(\frac{d^2f}{didj} \right)^2 \quad \text{Deter. of } H \quad (2)$$

Equations 1 and 2 are defined for the continuous function f , but we work with an image, which means a discrete space. Each point represents pixel intensity for this image at (i,j) coordinates. Approximated derivatives are then computed by convolution with an appropriate kernel (H is also approximated - H'). For the determinant approximation (D') the following formula is used:

$$D'(H') = D_{ij} \cdot D_{ij} - (0.9D_{ij})^2 \quad (3)$$

D_{ii}, D_{jj}, D_{ij} - are block responses (derivatives) in image for pixels at (i,j) , convolved with suitable mask.

Determinant computation is necessary for interest point detection (which are maxims in determinant matrix - see Fig. 2). The next step of the proposed method is construction of the scale space by producing image pyramids. We'll stop here because we have information about the foreground (or better said - we have candidates). If we wanted to continue with other stages, we can obtain better results, but the computation time increases with any other step.

Background modeling

An example of background modeling is the Mixture of Gaussians. In our experiments this method did not seem very robust for the given problem²⁾.

We used a model based on a simple principle:

$$res = f(t) - f(t - n) \tag{4}$$

res - result, *f(t)* - image intensity in time *t*; *f(t - n)* - image intensity in past.

It is the *background comparison model*, simple and easy to compute. To ensure better resistance more background models are maintained. The *first* example (eqs. 5 and 6) is a modification of the basic model from eq. 4.

$$res = f(t) - ref(t - 1) \tag{5}$$

$$ref(t) = f(1 - \alpha) \cdot ref(t - 1) + \alpha \cdot f(t) \tag{6}$$

Ref(t) - reference image (running average of background pixel intensity); α - remembering constant

Another model: if pixel is executed *n*-times in a sequence as foreground, then it is moved to background. We designed a model where two simple approaches are mixed together for background maintenance. If pixel in a given time *t* is decided to be a foreground in *both* models, then it is executed as foreground for a given time, otherwise it belongs to background. Such an approach should cope with long term and also some temporary changes. This model is not such a strong tool as, for example, Mixture of Gaussian which can adapt to weather or light changes very quickly. But with our approach, we can, firstly, better manage background models and, secondly, our dataset was collected in a specific (real) situation, so it needs a unique model.

Two different methods for the problem of foreground extraction were compared each other. Background modeling methods and invariant key point detector. The primary criterion was the rate of correctly identified objects passing the ROI. Better results were obtained with background modeling - background comparison model. Errors occurred especially in the situation when there were shadows. The Mixture of Gaussians (MoG) is another well known method for background maintaining. Our model is in advance in remembering objects for longer time compared to the MoG. MoG and background comparison models work with video sequences, SURF does not when it works just with one frame (time dimension is not used). The SURF does not need to maintain the background model (there is no problem with forgetting objects or light changes). Weakness of this method is that low contrasted objects are recognized very poorly, for small regions the SURF does not have to recognize any objects (see Fig. 4), the whole process is also time consuming against background comparison model. SURF is more reliable in situation where known objects are searched.

3. Classification Process

The main goal of this part is to provide additional information about the type of objects in given ROI. This information is then added to the information computed in the 2nd part. This part is not so important; it is just an illustration of another way of computing some information from image that can increase an informational character of the system. Generally, in this part we are interested in three types of objects (pedestrians, personal cars, other type of

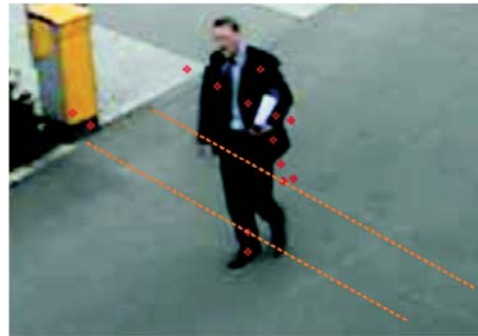

Fig. 3 An example when in ROI was an object, but it wasn't detected (ROI is the area between lines)

vehicles and false positives) - together four classes are distinguished. The highest score of positive object's identification moved up-to 92.5 %. Before classification, a successful foreground recognition has to be accomplished (previous part). If foreground candidates are known, ROI is shrunk just to a small region around object.

A simple classifier is used in our work based on the vector distance (MSE - Mean Square Error or Hamming distance). Each feature vector is computed from appropriate images. Two different inputs were compared. First input is the result from the foreground extraction process (frame subtraction, see Fig. 4) and the second one is obtained from edge images (see Fig. 6). Next, the vectors are computed from these images, their sizes move around 10-15 values. The character of these values is:

1. From *subtracted* images - eccentricity, percentage of pixels, centroids, compactness...
2. From *edge* images - number of single pixels, couples, triples, tetras, number of lines "-", "|", "/", "\", number of crosses "+", "x"...

These two types of vectors are used as input for our classifier³⁾. From the experiments it was clear that better results were achieved using the second type of inputs (edge images).

In previous text methods for information computing from images were introduced. At first foreground objects were extracted, secondly these objects were classified into classes. An example of a final information could be:

³⁾ All values need to be normalized.



Fig. 4 Results from background comparison model are shown, for various objects.

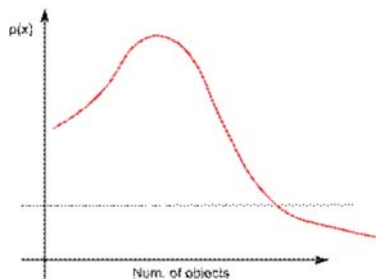

Fig. 5 Probability dependence of optimal message delivery and number of objects in communication is shown.

ALERT: On rail crossing is an object- it could be a car.

Next step is a delivery of this information to other traffic objects (a train approaching the affected rail crossing). The information delivery is discussed in next part.



Fig. 6 The image shows the process of edges extraction. Blur is applied on original image, then Sobel edge detector is used. Detected edges serve as input for classification process.

COMMUNICATION PROTOCOL

In this part we present framework for information representation. Common communication protocol is introduced. MANET (Mobile Ad-Hoc network) is used for information exchange. An important task in this type of network is to solve the problem how to represent information, what the message looks like and how to deliver the information. When the message is created, it is sent to MANET nodes which extract suitable information for themselves. The information from the message serves as basis for decision

process in different kinds of collision situations (as mentioned before – traffic jam, crashes etc.). The designed message should provide:

- Content for Emergency Warning Messages (content for information obtained from an image processing part).
- Generating next hop messages (messages that need to be transmitted to other vehicles).
- Ability to provide a message life cycle (registration, transfer, removal, etc.).
- Simplicity, universality etc.

Designed message is also restricted by physical characteristics of the system. There are limitations for example in a transmission rate, available bandwidth and transmission power of devices. Some implementation problems to be considered are:

- Message size (in kB).
- Insurance against unauthorized access to the message (it should be considered that a secure message can increase the message size).
- A small number of objects incorporated in communication can cause that the message will not be properly distributed.
- A lot of objects involved into communication can lead to congestion (see Fig. 6).

Content of the message

The common structure of the message in C2X –systems must provide:

- Autentification and identification (IP, MAC, secure certificate).
- Messages encoding.
- The size and the structure of the message must allow smart processing (compression).
- The possibility to use certification authorities.
- Information about state of the objects (position, velocity, direction, time stamp...).
- Information about *occurred events* (accident, emergency car passing, mist, etc.).
- Information about multimedia description of the message (image path or path to sound file).
- Covering information description:
- Source of the message (car, operation center, *computation center* hydrometeorological institute, etc.).
- Type of a distributed message (public, private).
- Communication language of the message (English, Slovak, etc.).
- Priority of the message (probability for certainty of given event).

Protocol definition

Possible solution is to define the message according the XML standards. This format ensures simple access regardless of used platform at which it runs. The message of this type (XML) fits the characteristic for a common communication protocol described earlier. The following list contains the definition of designed protocol:

- *identifier* – Unique number, or text string that identifies the message assigned to a sender.
- *sender* – Unique address identifying the creator of the message.
- *password* – Sender verification (secure function implementation).
- *source* – Identification of operator or device (vehicle).

- *sent* - Time and date of the sent message. Format is standardized in ISO 8601 (example: "2002-05-24T16:49:00-07:00").
- *scope* - Code for type of message distribution (Public, Restricted, Private).
- *msgType* - Type of the message (Alert, Update, Cancel, Ack, Error).
- *language* - Code of used language for the informational content. Code values standardized in RFC1766.
- *category* - (Security - military, legal, government, private, security, Geo - geophysics, Met - meteorological, etc.)
- *instruction* - Text of recommended action, for receiver.
- *headline* - Title of the message record.
- *GPS* - GPS data.
- Other data necessary to identify events.

Basic structure of the message is inspired from Common Alert Protocol [6]. Names of elements and their values satisfy communication standards to make the whole system functional.

Protocol implementation

The algorithm for message processing should meet the following requirements:

- Control of the environment.
- Receiving and evaluating messages.
- Process management and displaying messages.



Fig. 7 Example of simulation, for communication protocol

```
<alert xmlns = "http://www.incident.com/cap/1.0">
  <identifier>KSTO1055887203</identifier>
  <sender>KSTO@NWS.NOAA.GOV</sender>
  <sent>2010-01-17T14:57:00-07:00</sent>
  <status>Actual</status>
  <msgType>Alert</msgType>
  <scope>Public</scope>
```

```
...
<info>
  <category>Road</category>
  <event>RAIL CROSSING COLLISION</event>
  <urgency>Immediate</urgency>
  <severity>Severe</severity>
  <certainty>VeryLikely</certainty>
  <expires>2010-06-17T14:59:00-07:00</expires>
  <senderName>NATIONAL TRAFFIC SERVICE</senderName>
  <headline>ALERT : On rail crossing is an object.</headline>
  <description>VEHICLE STOPS ON RAIL
CROSSING</description>
  <instruction>POSSIBLE DANGEROUS SITUATION. BE
CAREFULL (SLOW DOWN)</instruction>
...
</info>
</alert>
```

The above XML description is an example of the message (a part of the message). This protocol accomplishes all the necessary requirements for C2X systems defined at the beginning of the 4th chapter. For this purpose a demo application was developed to acquire reliable information about its network abilities. The simulation model was created to analyze communication between various objects and for different types of traffic.

4. Distribution of the information

Both static and mobile objects participate in communication. When the result of image processing is transmitted the holder of the original information is a computational center. It is a static object and, therefore, it is important to use the model of "off-line replication". At first it is necessary to grasp properties of on-line and off-line replication.

Off-line replication [7]

- Data are originally stored in one node then they are replicated to another one.
- Suitable for standard access methods.
- Issues:
- Users get only meta-data information concerning created replicas, e.g., by email or through the web-site.

On-line replication

Receivers of messages from the computational center are mobile users. Each of them forwards message to another user. In this case it is called on-line replication.

- Data replicas are created parallel by the node and shared between mobile users.
- Limitations:
- Suitable for 'custom' access methods, incompatible with 'standard' ones.
- Hard to implement, possible performance delays.

Where to send a message?

The question is which node should be addressed with a new message and how to deliver the message. It is already known what the message looks like. Next step is to deliver it. The holder of the original message is the computational center. The message needs to be transmitted over Ad-Hoc network from this center. The receiver of the message is a mobile object (vehicle, train). The algorithm has to be implemented, which can administrate sudden changes in the network topology (connecting disconnecting objects etc.).

Different algorithms for the mentioned purposes are analyzed.

1th Algorithm – simple approach

- The computational center creates a set of available clients (S_i which is regularly updated – in very short intervals).
- The computational center broadcasts short messages (ack.) about available information to an object from S_i . This information is broadcasted repeatedly (during the time it is valid).
- Time period is established for client to respond.
- If during the time period, one or more clients respond, the communication is considered as successful and the message with information is sent to the client.
- If some nodes from S_i do not respond to the computational center during a given period of time, they are disqualified for the next time period (disqualification period). They are moved to DQL – DisQualification List (if nobody answers, time period can be increased).

The algorithm described above ensures availability of original data, but it does not consider requirements of a single client. Clients do not have to demand all the data (just part of them – replica). The proposed Simple algorithm does not provide mechanism for information confirmation. Another algorithm is introduced.

2th Algorithm – algorithm based on confirmation

Let us suppose a set of mobile clients S_i . Each of them has a request for updating the original data. Let us further suppose R_i as a set of such requests (R_i is a subset of original data). Then the algorithm for replication request (R_i) from the client S_i can be:

- The computational center (holder of original data) emits its identifier to environment (id + time stamp of the last update).
- The client S_i sends a request for replication R_i from the computational center.
- The computational center processes the request and sends a response to the client.
- If the client receives a complete message, it sends acknowledgement to the computational center.

- The computational center erases R_i from the list of requirements.
- If the client during the time period t does not answer, the computational center checks availability of this client, t is increased and the message is repeated.
- If the client does not respond for a certain amount of efforts, the communication is stopped and the client's request R_i is erased from the request list.

5. Conclusion

In this paper we presented a model for detection and delivery of information about unwanted events in traffic systems (recognition objects in given ROI). Two demos were created to prove the functionality of the model. The first model is for image processing. It is designed for recognition of foreground objects and for providing information about unwanted events. Another demo is a simulation of data delivery and protocol utilization. For image recognition and classification we worked with about 20 video sequences with different objects approaching ROI. It was about 28 minutes of records. We obtained up to 97% of correct assignments. It means that 3 % of objects passing given ROI were identified negatively. For classification part the highest score of correct assignments objects into classes moved around 92, 5%. From the protocol simulation the following conclusion can be made: the protocol meets many of the requirements and could be effectively used for common tasks in mobile Ad-Hoc networks. XML standard ensures its universality, simplicity etc.

6. Future work

We would like to continue with a design of foreground recognition system (general image processing tasks). There is a need to cope with shadows, sudden light changes and also with high level of details in a specific situation. We would like to test the proposed methods in different real situations (detecting weather conditions to inform drivers, detecting traffic jams etc.). For the part of information delivery, it is necessary to test algorithms for effective data replication. It is also important to have in mind a power range of devices which will be used (e.g. NEC LinkBird-MX).

Acknowledgement:

This contribution is the result of the project implementation: **Centre of excellence for systems and services of intelligent transport**, ITMS 26220120028 supported by the Research & Development Operational Programme funded by the ERDF.



Agentúra
Ministerstva školstva, vedy, výskumu a športu SR
pre štrukturálne fondy EÚ

"Podporujeme výskumne aktivity na Slovensku/Projekt je spolufinancovaný zo zdrojov EU."

References

- [1] BADURA, S., LIESKOVSKY, A.: *Advanced Utilization of Image Processing from Industrial Cameras in Traffic*. In: Proc. EURO-Zel Zilina 18th International Symposium, ISBN: 978-80-554-0198-0, pp. 153–160, 2010.
- [2] YILMAZ, A., JAVED, O., SHAH, M.: Object Tracking: A Survey. In: *ACM Comput. Surv.* 38, 4, Article 13, p. 45, 2006.
- [3] LOWE, D. G.: *Object Recognition from Local Scale-invariant Features*. In: Proc. of the International Conference on Computer Vision, pp. 1150–1157, 1999.
- [4] BAY, H., ESS, A., TUYTELAARS, T., VAN GOOL, L.: SURF: Speeded Up Robust Features. In: *Computer Vision and Image Understanding (CVIU)*, Vol. 110, No. 3, pp. 346–359, 2008.
- [5] STAUFFER, CH., GRIMSON, W.E.L.: *Adaptive background mixture models for real-time tracking* [online].
- [6] OASIS: Common Alerting Protocol, v. 1.0. OASIS Standard 200402, March 2004. http://www.terena.org/activities/tf-storage/storage/meetings/1/NDS_PSNC_collaboration_on_storage_services.ppt [online].

Jan Rofar – Maria Franekova – Peter Holecko *

MODELLING OF SAFETY CHARACTERISTICS OF REDUNDANT SAFETY – RELATED TRANSMISSION SYSTEM VIA MARKOV'S ANALYSIS

The paper deals with problems of safety features modelling using a safety-related redundant transmission system as part of a safety – critical control system. The main part of the paper is oriented to the Markov model description which was realised for a 1oo2 redundant transmission system. The results of quantitative safety analyses are valid for the fail safe redundant transmission system – Profibus DP with a ProfiSafe safety profile.

Keywords: safety-related transmission system, industrial application, modelling, quantitative analysis, Markov model, safety code, transmission code, SHARPE

1. Introduction

In control safety-critical processes in industrial applications safety-relevant industrial communication systems are being used for transmission of safety-relevant data, which are characterised by a high resistibility against hazardous failures. The consequences of failures on a communication system's operation can be examined directly on the original system or by the system's operation simulation using a proper constructed model or by theoretical considerations and calculations. It is necessary to point out that in most cases the strict safety requirements on a safety-relevant industrial communication system cannot be proved only by tests or practical results because the dangerous state percent occurrence of a communication system is very low. Therefore the value of mean time between hazardous failures many times exceeds the operational time of system. During safety analyses it is necessary to provide a proof that the resultant risk is acceptable and the safety requirements are met.

The goal of the analysis of failures consequences on an industrial communication system is to construct a model which enables to identify the system's transition process from a safe state to a hazardous state and allows calculating the probability of hazardous system state occurrence as a result of failures effects on the system's operation. An industrial communication system consists of terminal equipment and a transmission system. In most cases the vendors of safety-relevant devices indicate the resulting SIL (Safety Integrity Level) so only characteristics of the transmission system have to be examined.

The transmission system usually does not operate isolated but is a part of another superior system providing service for it. There-

fore, the starting point of building a safety model is an exact definition of the interface between the transmission system and the superior system for the purpose to enable a complete hazard identification which has to be considered during the transmission system safety analysis. It is also necessary to explicitly define the event on the transmission system's output which is considered unwanted (hazardous) in respect to safety properties of the transmission system. An unwanted event usually includes an undetected data transmission corruption and the next data manipulation is considered to be correct.

The knowledge of a transmission system failure and error attributes create basic assumptions for realising measures not only for failure prevention but also for failure detection and failure consequences negation. It is necessary to know where, when and what failures occur in systems, what are their reasons and consequences on the system. From this point of view the considered failures can be in principle classified in [1]: random failures of the transmission system's hardware part, failures caused by EMI (*Electromagnetic Interferences*) and systematic failures of the transmission system.

Industrial communication systems with a higher safety integrity level often involve compound safety techniques in failure states based on a redundant multichannel structure. Then the execution of a safety-relevant function is realised independently by at least two functional units. The compound safety systems utilise several forms of redundancy for achieving the required safety integrity level [1].

The article presents a model of a 1 out-of 2 (1oo2) system.

* Jan Rofar, Maria Franekova, Peter Holecko

Faculty of Electrical Engineering, University of Zilina, Slovakia, E-mail: jan.rofar@fel.uniza.sk

2. The Sense of Safety-Relevant Industrial Communication System Modelling

Usually when modelling a safety-relevant industrial communication system several system parameters are being observed, which are a part of the system's technical quality care. Among these are reliability, safety, operational life, availability, no-failure operation and maintainability [2]. The generic standard IEC 61508 [3] recommends focusing on four parameters within the system lifetime: Reliability, Availability, Maintainability, Safety (RAMS), as illustrated in Fig. 1, which provides a more global view of the system safety. The defined system attributes can be fulfilled only with the use of additional safety measures (so-called Fault prevention, Fault tolerant or Fault forecast system) by which the effects of failures or failure states can be eliminated. In case it is not possible to exclude an unauthorised access to the industrial communication system besides RAMS parameters it is necessary to watch security attributes such as confidentiality, integrity and availability.

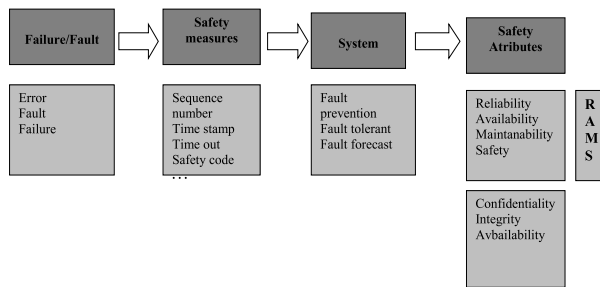

Fig. 1 A more complex look on industrial communication system safety

In praxis we encounter most frequently the following requirements related with the modelling of safety properties of an industrial communication system:

- Improvement of safety properties of an existing product or development of a new product, respectively. It is necessary to modify the safety layer and some algorithms of a communication protocol or to create a new protocol with the aim to increase the strength of safety mechanisms; when solving this type of tasks the Unified Modelling Language (UML) can be successfully utilised;
- Demonstration of safety properties of a new product It is necessary to demonstrate that the industrial communication system has a sufficient resistibility to attacks against transmitted messages by calculating the intensity of undetectable corruption of a transmitted message based on theoretical considerations (analysis of protocol safety properties, estimation of communication channel bit-error rate (BER), calculation of residual error rate of used codes, estimation of transmission system hardware failures intensity, ...) and also the results of the communication system testing in failure-free and failure operation; in this case we can use suitable combinations of modelling methods (RBD [4], FTA [5], FMEA [6], Markov model [7], Petri networks

[8], ...) or software tools supporting these methods (e.g. BQR reliability engineering [9], RELEX software [10], ITEM software [11], Matlab - Communications Toolbox [12], OPNET Modeler [13]).

3. Markov Model Creation

A simultaneous influence of several factors on the transmission system safety can be well described by Markov model. Figure 2 shows a block scheme of a redundant channel structure 1₀₀2 of a safety-relevant Profibus DP transmission system extended by a special ProfiSafe safety module [14]. A two channel structure is composed of two transmission channels connected in parallel, which perform the safety function of provisioning transmission integrity and eliminating the EMI influence with the use of implemented safety mechanisms in a form of safety code (SC) [15] and transmission-code TC [15] independently in both channels. This means that in case of a failure or system malfunction the hazardous failure had to occur in both channels.

The probability of undetected error p_u with using a block linear channel (n, k) code (transmission or safety code) can be approximated by the relation

$$p_u \cong \frac{1}{2^{n-k}} \binom{n}{d_{\min}} p_b^{d_{\min}} (1 - p_b)^{n-d_{\min}} \quad (1)$$

where the symbols represented:

- n codeword length,
- k information word length,
- d_{\min} minimal Hamming distance,
- p_b bit error rate of communication channel

Note: we assume model of BSC (Binary Symmetric Channel)

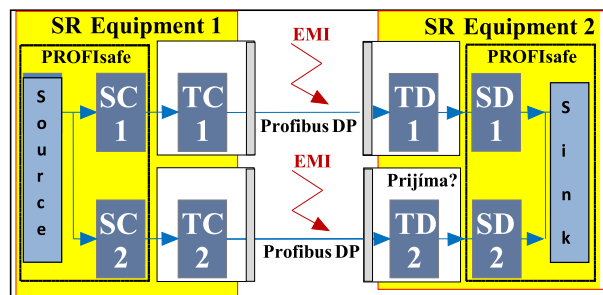

Fig. 2 Two-channel redundant structure of a safety-relevant transmission fieldbus system

Let's assume that any diagnostic testing can detect transmission errors only, not correct them. Furthermore, let's suppose that the individual transmission channels are of different hardware construction and that the safety mechanisms and the transmission mode have a cyclic character which is initialised by a master type transmission device.

Figure 3 represents a model of a two-channel redundant structure of a closed safety-relevant Profibus DP transmission system

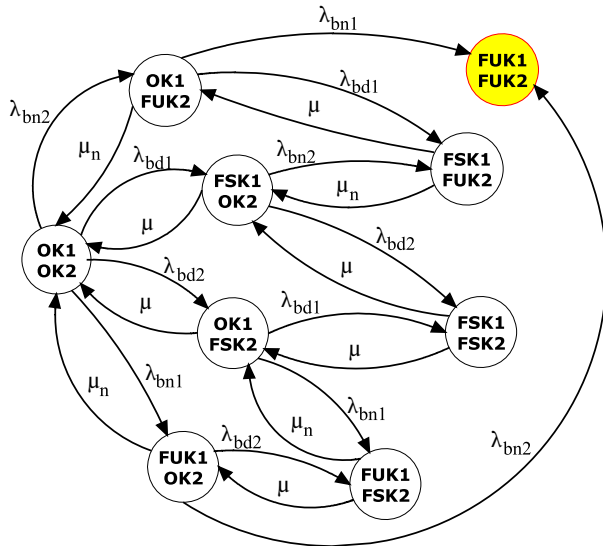

Fig. 3 Markov diagram of a redundant two-channel 1oo2 structure of a transmission structure

at a two-point connection level which is realised using Markov analysis. The meaning of individual states and transitions is characterised in Table 1.

At the beginning the redundant industrial safety-relevant system is in operating state in both transmission channels OK1 and OK2. On the occurrence and detection of a transmission error the system passes in both channels to the state of defined failure reaction, a so-called Fail Safe state: FSK1 and FSK2 with the intensity λ_{bd} and subsequently requests a repeated message sending, i.e. the system returns to operating states OK1 or OK2 with intensity μ . In case the transmission error remains undetected (Fail Unsafe state) the system passes to FUK1 and FUK2 states with intensity λ_{bn} . If the states FUK1 and FUK2 don't occur at once, the discrepancy between transmission channels is detected based on diagnostic testing and the system switches again to operating states OK1 or OK2 with diagnostic testing recovery intensity μ_n . In case that both these states FUK1 and FUK2 occur at the same time the system ends up in a hazardous state of undetected transmission error.

4. Results

The safety analysis of the model depicted in Fig. 3 was realised with the use of a transmission and safety code in form of cyclic block CRC (Cyclic Redundancy Check) codes (specifically CRC-16 and CRC-8) whereby the independence of generating polynomials is emphasised. As the input parameters for calculation of safety attributes: intensity of hazardous (critical) failures λ_{kr} [h^{-1}], mean time to failure $MTTF_{kr}$ [h] statistical values of BER [-] were used, for the physical Profibus DP bus layer RS 485 (transmission rate 9,6kbit/s) for which the probabilities of undetected hazardous transmission code error in both channels p_{u_bk1} [-] and p_{u_bk2} [-]

States and transitions for the diagram in Figure 3 Table 1

State	State description
OK1	Transmission of uncorrupted messages between devices. Channel 1 operational state.
OK2	Transmission of uncorrupted messages between devices. Channel 2 operational state.
FSK1	Channel 1 safety decoder detected a corrupted message. It is a safe failure state of transmission channel 1.
FSK2	Channel 2 safety decoder detected a corrupted message. It is a safe failure state of transmission channel 2.
FUK1	Channel 1 safety decoder did not detect a corrupted message. It is a hazardous failure state of transmission channel 1.
FUK2	Channel 2 safety decoder did not detect a corrupted message. It is a hazardous failure state of transmission channel 2.
Transition	Transition description
OK1→FSK1	The transition occurs in dependence on transmission channel 1 message error, which is consequently detected by channel 1 safety code.
OK1→FUK1	The transition occurs in dependence on transmission channel 1 message error, which is not detected by channel 1 safety code.
FSK1→OK1	The transition occurs in dependence on failure handling mechanism and the repeated transition to transmission channel 1 operational state. In most cases on operator confirmation.
FUK1→OK1	The transition occurs in dependence on diagnostic testing mechanism of both transmission channels and the repeated transition to transmission channel 1 operational state. In most cases on operator confirmation.
OK2→FSK2	The transition occurs in dependence on transmission channel 2 message error, which is consequently detected by channel 2 safety code.
OK2→FUK2	The transition occurs in dependence on transmission channel 2 message error, which is not detected by channel 2 safety code.
FSK2→OK2	The transition occurs in dependence on failure handling mechanism and the repeated transition to transmission channel 2 operational state. In most cases on operator confirmation.
FUK2→OK2	The transition occurs in dependence on diagnostic testing mechanism of both transmission channels and the repeated transition to transmission channel 2 operational state. In most cases on operator confirmation.

were calculated according to relation (1). The calculation was providing that the generation frequency of safety-relevant messages from source 1 and from source 2 is $f_{brs1} = f_{brs2} = 18\ 000$ messages/h.

The resulting safety attributes values of a redundant two-channel structure can be found in Table 2. The graphs of safety function

$S(t)$ which represents the time dependence of the system getting into an undetected failure state while using a two-channel redundant structure FUK1 and FUK2 are shown in Fig. 4. The results were obtained using the SHARPE modelling tool [16].

The graphs in Fig. 4 represent results with the recommended type of CRC code used in the ProfiSafe profile in both cases the CRC-16 only with different generating polynomials.

The curve of function $S(t)$ 2 and 3 is a result of CRC codes combination, as stated in Table 2. From the results obtained it is obvious that the scheme with 1_{oo}2 redundant structure fulfils the safety integrity level SIL3 requirements where the tolerated intensity of hazardous failures per hour is within the limits from 10^{-8} to 10^{-7} .

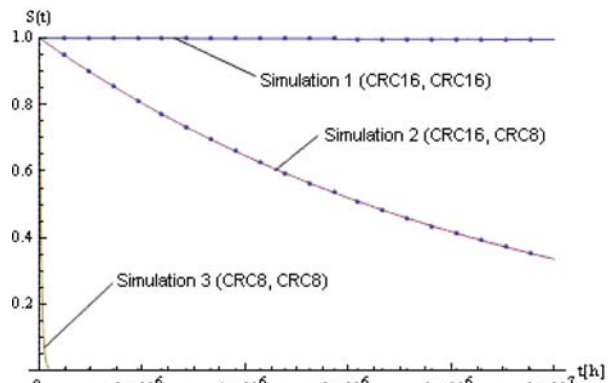

Fig. 4 Graphs of $S(t)$ safety function for Markov diagram in Fig. 3

Input and output values for the diagram in Fig. 3 Table 2

Denotation	Simulation 1	Simulation 2	Simulation 3
	9.6kbps, CRC 16, CRC 16 (O)	9.6kbps, CRC 16, CRC 8 (O)	9.6kbps, CRC 8, CRC 8 (O)
f_{brs1} [h^{-1}]	18000	18000	18000
f_{brs2} [h^{-1}]	18000	18000	18000
p_{ned_bk1} [-]	$1.52588 \cdot 10^{-5}$	$1.52588 \cdot 10^{-5}$	0.00390625
p_{ned_bk2} [-]	$1.52588 \cdot 10^{-5}$	0.00390625	0.00390625
p_{brch1} [-]	0.00127919	0.00127919	0.00127919
p_{brch2} [-]	0.00127919	0.00127919	0.00127919
λ_b [h^{-1}]	1	1	1
λ_d [h^{-1}]	1	1	1
MTTF _{kr} [h]	$2.34 \cdot 10^9$	$9.17 \cdot 10^6$	$3.59 \cdot 10^4$
λ_{kr} [h^{-1}]	$4.27691 \cdot 10^{-10}$	$1.09099 \cdot 10^{-7}$	$2.78311 \cdot 10^{-5}$

point connection in case that both transmission channels use different transmission media or their transmission is ensured by different safety mechanisms.

The constructed model represents a suitable tool for quantitative safety analysis of a safety-relevant Profibus DP-type transmission system which has a wide application within the frame of safety-critical processes control in industry. The described method is suitable for modelling of safety properties of dynamic systems where the occurrence of random failures (caused for example by aging, physical corruption of the transmission system's hardware components and unintentional EMI failures) is expected. It is created for the Profibus DP safety profile but with a change of input parameters or after a minor modification of the individual models it is also applicable for quantitative safety analyses of other safety fieldbus systems.

Acknowledgement:

This contribution is the result of the project implementation: **Centre of excellence for systems and services of intelligent transport**, ITMS 26220120028 supported by the Research & Development Operational Programme funded by the ERDF.

5. Conclusions

Using the presented model it is also possible to realise a safety analysis of a two-channel redundant structure at the level of a two-



Agentúra
Ministerstva školstva, vedy, výskumu a športu SR
pre štrukturálne fondy EÚ

"Podporujeme výskumne aktivity na Slovensku/Projekt je spolufinancovaný zo zdrojov EU."

References

- [1] ZAHRADNIK, J., RASTOCNY, K., KUNHART, M.: *Bezpečnost železničných zabezpečovacích systémov* [Safety of Railway Control Systems], EDIS ZU, Zilina, 2004, ISBN 80-8070-296-9 (in Czech).
- [2] MYKISKA, A.: *Bezpečnost a spoľehlivosť technických systémov* [Safety and Reliability of Technical Systems], CVUT Praha, 2006, ISBN 80-01-02868-2, (in Czech).
- [3] IEC 61508: *Functional Safety of Electrical/Electronic/Programmable Electronic Safety-Related Systems*, 1998.
- [4] BILLINTON, R., ALLAN, R. N.: *Reliability Evaluation of Engineering System - Second Edition*, Extension College of Engineering University of Saskatchewan Saskatoon : Saskatchewan : Canada. 2007.
- [5] CICHOCKI, T., GORSKI, J.: Failure Mode and Effect Analysis for Safety-Critical Systems with Software Components, *Lecture Notes in Computer Science*, Springer Berlin : Heidelberg, ISSN 0302_9743 (Print) 1611-3349 (Online).
- [6] JESTY, P. H., HOBLEY, K. M., EVANS, R., KENDALL, I., CARS, J.: *Safety Analysis of Vehicle-Based Systems*, In: www.scholar/google.sk.
- [7] BUKOWSKI, J. V., GOBLE, W. M.: Using Markov Models for Safety Analysis of Programmable Electronic Systems, *ISA Transactions*, Vol. 34, 1995, pp. 193-198.
- [8] LEE, W. J., KIM, H. N.: A Slicing-Based Approach to Enhance Petri Net Reachability Analysis, *Journal of Research and Practice in Information Technology*, Vol. 32, No 2, 2000, 131
- [9] www.bqr.com
- [10] www.relexsoftware.de
- [11] www.itemuk.com
- [12] FRANEKOVA, M.: *Modelovanie komunikačných systémov v prostredí Matlab, Simulink a Communications Toolbox* [Communication Systems Modelling in Environment Matlab and Communications Toolbox], ZU, 2003, ISSN 80-8070-027-3 (in Slovak).
- [13] www.opnet.com.
- [14] MALIK, R., MUHLFELD, R.: A Case Study in Verification of UML Statecharts: the PROFIsafe Protocol, *Journal of Universal Computer Science*, Vol. 9, Issue 2p, pp. 138-151.
- [15] EN 50 159 - 1: *Railway Applications: Communication, Signalling, and Processing Systems - Part 1: Safety-related Communication in Closed Transmission Systems*, CENELEC, 1999.
- [16] SHARPE Manual, <http://www.ee.duke.edu/~chirel/MANUAL/manualSharpe.pdf>.

Eric Mendes – Paulo E. M. Carvalho – Luís M. Ferreira Gomes *

HYDROGEOLOGIC FRAMEWORK OF THE GARDUNHA MOUNTAIN: NORTHEAST AREA – CENTRAL PORTUGAL

The present paper describes the hydrochemical evolution of mineral groundwater in the northeast area of Gardunha mountain (centre region of Portugal) which is formed by low permeability igneous rocks. For this study were considered 50 water samples and analyzed the values of major ions. The methodology used consisted in the use of Piper diagrams that had allowed to identify the water chemistry and in the application of statistical techniques of multivariate analysis, including factor analysis. The results guided to sodium-bicarbonate water type, with very low mineralization, designated by fresh water in relation to total solids and soft in relation to hardness. When using the factor analysis, 4 factors were considered, which explain and identify the origin of the presence of ions and their geochemical processes.

1. Introduction

The groundwater is a natural resource essential to the life and the integrity of the ecosystems, representing more than 95% of the Earth fresh water reservoirs that can be explored. Most of the agricultural and industrial activities depend on groundwater, which is also fundamental for the public supply, once more than a half of the world population depend on this groundwater. In Europe, the groundwater supplies approximately 65% of the water used for human consumption [1].

Being a natural resource this water has had a decisive role in the flourishing of civilizations and constitutes nowadays a privileged source of most public and private supplies [2].

The quality of the groundwater is given by the dissolution of the minerals present at the rocks that constitute the aquifers and the percolation through them. Nevertheless, other factors may influence its quality, such as the composition of the recharge water, the residence time, the interaction water-physical environment, the climate and even the pollution caused by human activities.

In the whole world the aquifers are at risk of being contaminated because of the urbanization, the industrial development, the agricultural activities and the mine extractive industries.

In Portugal, having already some knowledge in the hydrogeological area, it is possible to identify for some hydrogeological units the existence of potential reservoirs that should be better acquainted

and evaluated, once, if they were well used, they could become “emergency structures”, providing help in crisis situations.

However, among all these needs what emerges as being particularly relevant is the supplying of water for human purposes, which demands high quality standards, either in the water supply or in the service provided to consumers.

With this present study we intend to contribute to the hydrogeological and hydrochemical knowledge of the northeast area of Gardunha mountain (centre region of Portugal).

2. Study area

The Gardunha mountain is a structural unit perfectly individualized which belongs to the Iberian Massif, and it is limited for several depressions in which stands out on the SE the highest area of the hydrographic basin of the Riverside of Alpreade, where it is located Castelo Novo (Fig. 1). This mountain is characterized physically as an area with a rugged landscape, it presents to the West old formations composed by metamorphic shale and to the East granitic igneous lands, culminating to the elevation 1227m.

The captations in study are located all in hercynian granitic orogeny of varied textures. Locally they form two different granitic series, although, to the genetic-tectonic and chemical-mineralogical point of view they seem to make a junction in an only branch, within the orographic hercynian: (1) granites with biotite-oligo-

* Eric Mendes, Paulo E. M. Carvalho, Luis M. Ferreira Gomes
Universidade da Beira Interior, Departamento de Engenharia Civil e Arquitectura, 6201-001 Covilhã, Portugal, E-mail: emendes@ubi.pt

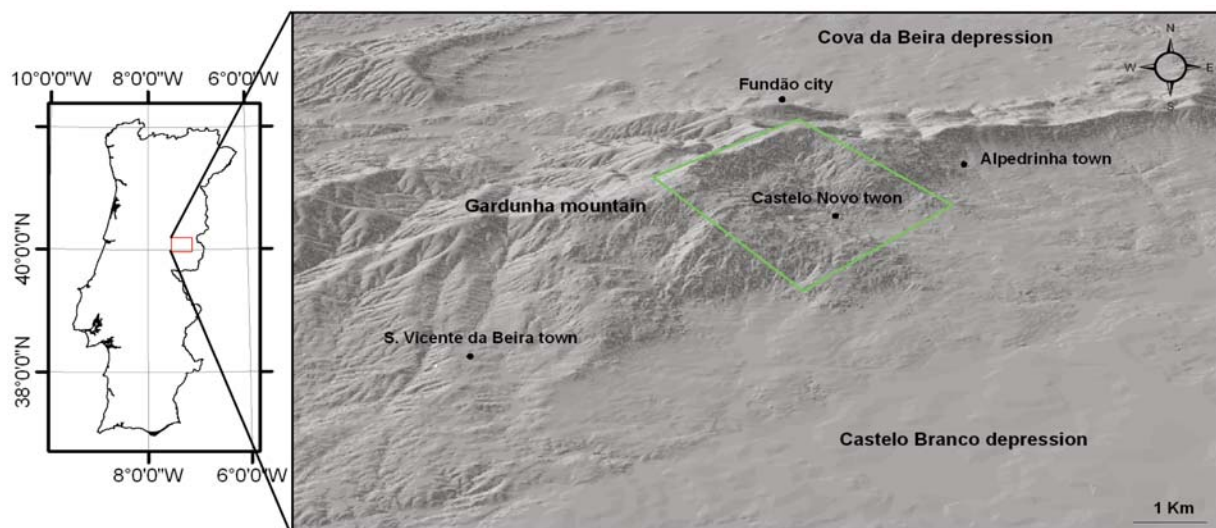

Fig.1 Location map of the study. The green line delimited the study area.

clase mega crystals; (2) post tectonic granites bounded in massifs, usually biotitic and frequently with mega crystals.

As for the constitution of mineralogical essentials they have quartz, oligoclase, microcline, microcline-partite, albite-oligoclase and biotite. As secondary elements there is muscovite, apatite, zircon, turmaline, magnetite, ilmenite, pyrite, fluorite [3].

The granitic rocks and the surrounding grounds are affected by tectonic hercynian and late-hercynian actions that lead to metamorphism, folding and fracture. The fracture is noticed by the presence of fault lines widely spread all over the area, situated mainly NNE-SSW and NE-SW, where sometimes one can find pegmatitics, aplite-pegmatitics and hydrothermal veins of quartz [3].

The localization of the springs is conditioned by the presence of permeable conducts, due not only to this tectonic fracture but also because of the piezometric and topographical surface. Some of these factors were reactivated in the Quaternary, occurring at the same time the thermal springs with the presence of the active faults [4].

From the climatic elements available to the characterization of the area of study, was used the information related to the precipitation registered in the weather centre of Castelo Novo 13M/03G [5]. For the monthly rating of the hydrological balance, it was used a methodology suggested by Thornthwaite and Mather [6] and through the results one can notice the emergency of a dry period and a damp period, being the first due to the hydraulic shortage, that goes from June until September, having its peak in August, and the second, the damp period, is due to the hydraulic superavit, that goes from October until May, having the greatest amount of water in January.

In terms of hydrogeological units, as a whole, it is accepted as valid that it corresponds to a aquifer of the phreatic fissural type,

with hydraulic conductivity that varies between 0.008 and 2.38 m/d and transmissivity values that vary between 0.28 e 54.8 m²/d.

The groundwater flow is not very deep, as proved especially by the low mineralization of the water, considering that it is an aquifer of common superficial water, containing mainly infiltration waters and local flow, lasting for short periods of time.

The speed of the flow is generally high, given the type of permeability per fracture; the maintenance of the streams, even during the dry period, is probably due to the capacity of regularization of the alteration areas that covers some of the rechargeable areas. During the dry periods above all the permeability, because of the porosity of the alteration areas, plays a very important role, although all the hydraulic action is conditioned by the flowing through the fractures.

A hydrogeological conceptual model for this region is showed in Fig. 2, showing that the infiltrated water tends to emerge in places not very distant, nevertheless notice that part of the groundwater flow can evolve to great depth along the large faults, recharging deep aquifers.

3. Analytical Methods

In order to study the groundwater quality, 50 groundwater samples have been collected for analysis of major and trace elements. pH and electrical conductivity ($\mu\text{S}/\text{cm}$) were measured at the sampling site by the use of a multi-parameter analyzer, SCHOTT - PH/LH 12. The following methods were applied for chemical analyses performed at the Laboratory of Analyses of the Technical Institute (Instituto Superior Técnico): molecular absorption spectrometry for SiO_2^{2+} ; atomic absorption spectrometry for Pb, Cu, Cr, Sr, Rb; ion chromatography for Cl^- , HCO_3^- , NO_3^- , SO_4^{2-} , Ca^{2+} , Mg^+ , K^+ , Na^+ .

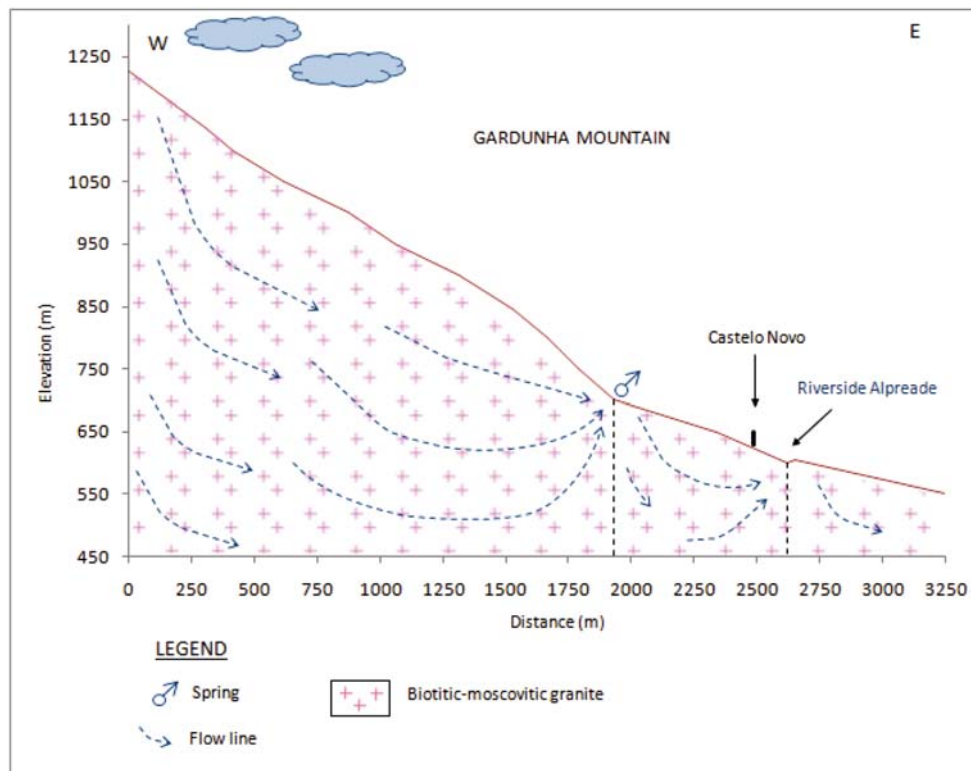

Fig.2 Hydrogeological conceptual model in the studied area

4. Results and discussion

Hydrochemistry

According to the analytical data (Table 1), in the groundwater investigated, the average pH is about 5.76 and the electrical conductivity (EC) ranges from 20-30 $\mu\text{S}/\text{cm}$. The total dissolved solids (TDS) vary from 24.2 to 41.3 mg/l, the average value being of 31.6 mg/l, is fresh water based on Freeze and Cherry (1979) classification.

The dominant ions in solution are HCO_3^- and Na^+ , which represent on average respectively 61 and 71% of the total content of anions and cations.

The $\text{Cl}^- > \text{SO}_4^{2-} > \text{NO}_3^-$ anions are secondary in importance, representing on average 39% of all anions. Among the cations $\text{Ca}^{2+} > \text{K}^+ > \text{Mg}^{2+}$ are less abundant, they represent on average 29% of all the cations. The concentration of SiO_2^{2+} varies between 9.5 and 18.4 mg/l. These contents of dissolved silica can be related to the hydrolysis of the silicate minerals present in the igneous rocks. This process could also contribute to the rise of the contents of HCO_3^- and alkali metals (Na^+ and K^+) or alkali muddy (Ca^{2+} and Mg^{2+}).

According to the physical-chemistry composition presented, this groundwater is classified as bicarbonate-sodium type (Fig. 3), hypo-saline with acid and silicate reaction.

Summary statistics of the geochemical analysis

Table 1

Water quality parameters	Units	Min.	Max.	Average	Median	Guideline value WHO (2004)
pH	-	5.34	6.19	5.76	5.77	6.5-9.5
EC	$\mu\text{S}/\text{cm}$	20	30	24.1	23	-
TDS	mg/l	24.2	41.3	31.6	30.5	1200
SiO_2^{2+}	mg/l	9.5	18.4	13.9	13.5	-
Cl^-	mg/l	1.9	2.6	2.14	2.1	250
HCO_3^-	mg/l	4.2	11.8	7.24	7	-
SO_4^{2-}	mg/l	0.2	0.6	0.39	0.4	500
NO_3^-	mg/l	0.03	3.69	2.19	2.28	50
Na^+	mg/l	2.6	4.7	3.71	3.6	200
K^+	mg/l	0.29	0.51	0.39	0.41	-
Mg^{2+}	mg/l	0.14	0.65	0.3	0.27	0.4
Ca^{2+}	mg/l	0.51	1.44	0.81	0.75	-
Cr	$\mu\text{g}/\text{l}$	0.09	0.5	0.2	0.2	5
Cu	$\mu\text{g}/\text{l}$	0.2	2.2	0.48	0.27	200
Rb	$\mu\text{g}/\text{l}$	1.4	2.4	1.83	1.85	-
Sr	$\mu\text{g}/\text{l}$	2.4	4.85	3.16	3	-
Pb	$\mu\text{g}/\text{l}$	0.01	0.3	0.08	0.06	1

To evaluate whether or not these waters could be used for drinking purposes, the chemical data was compared with the maximum permissible concentrations indicated in the World Health Organization guidelines [7] and reported in Table 1. Nearly all the analyzed samples fall within the range of drinkable waters, with the exception of a few whose Mg^{2+} (maximum value 0.65 mg/l) contents were high. This excess can probably be referred to natural water-rock interaction processes.

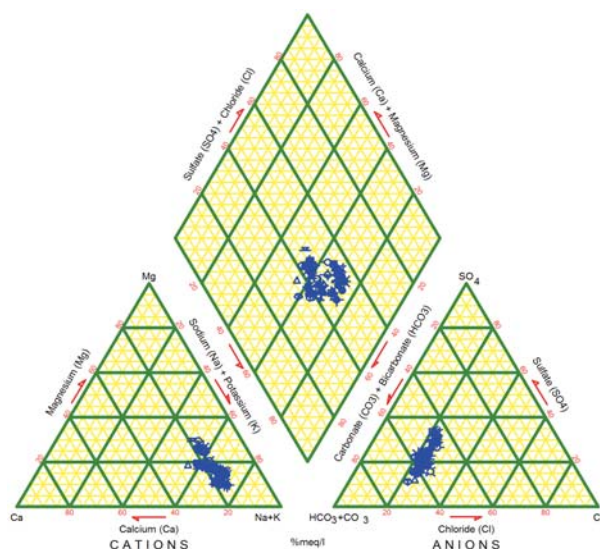

Fig. 3 Piper trilinear diagram of water chemistry in Castelo Novo

From the interpretation of the chemical analyses made during this study, it can be noticed a relative temporal stability of the chemical characteristics of the different elements, thus allowing to provide a hydrogeochemical characterization and the definition of the base contents of these aquifers, any time of the year, without any data loss.

Multivariate analysis

One of the fundamental problems associated with any environmental diagnosis, is linked to the great amount of data one has to deal with. The large dimension of the tables, either because of the number of samples or variables, makes impracticable any ‘manual’ research of relations, being necessary the asset to mathematical techniques of data processing that can synthesize, with a minimum of data loss, the most relevant information. Such techniques belong to the family of the Factorial Methods of Data Analysis, where the analysis in principal elements is included.

The objective of the factorial analysis is to study the chemism of the aquifer and explain the diversification of data through a small number of factors [8]. The practical application of the methods of factorial analysis to hydrogeochemical studies of aquifers has an undeniable success [9, 10, 11, 12, 13].

In order to clarify the relations between the variables in the samples of groundwater, it was characterized each pattern created

from the binomial samples versus variables (50×14 , being 50 the number of samples and 14 the number of variables).

The tables 2 and 3 present, respectively, the co-ordinates of the variables in the factorial axes, the real value and the percentage of the variance explained for each one of the factorial axes, resulting of the Analysis in Principal Elements of the 50 samples of groundwater.

Co-ordinates of the variables in the factorial axes Table 2

Variables	Factor 1	Factor 2	Factor 3	Factor 4
SiO_2^{2+}	0,90	-0,04	-0,11	-0,28
Cl^-	0,55	0,47	-0,42	0,08
HCO_3^-	0,93	-0,15	0,23	-0,12
SO_4^{2-}	-0,62	-0,01	-0,33	-0,05
NO_3^-	0,04	0,30	-0,34	0,85
Na^+	0,89	-0,01	-0,26	-0,13
K^+	0,45	0,13	-0,73	-0,23
Mg^{2+}	0,50	-0,15	0,79	0,16
Ca^{2+}	0,92	-0,01	0,13	0,21
Cr	0,03	-0,77	-0,12	-0,21
Cu	-0,02	-0,83	-0,27	0,31
Rb	0,87	-0,06	-0,25	-0,03
Sr	0,86	-0,06	0,20	0,34
Pb	-0,04	-0,88	-0,24	0,17

Results of the Analysis in Principal Elements Table 3

Factor	Value Equity	Variance %	Total variance %
1	5.97	42.61	42.61
2	2.43	17.33	59.94
3	1.96	14.00	73.94
4	1.25	8.90	82.84

In a first analysis one can notice that the first 4 factors explain 82.84% of the total variance. The application of this method also allowed the reduction of the ‘dimensionality’ of the problem (14 original variables) only to 4 ‘potential’ variables.

In Fig. 4a) and 4b) is presented the projection of the different variables in the first and second factorial plans defined, respectively, by the factors 1 and 2 and by the factors 1 and 3. This visualization of the projections of the variables in the plan allows distinguishing the closeness and conflicts existing within them. The first factorial plan constituted by the factors 1 and 2 include 59.94% of the information contained in the pattern of correlation.

Factor 1 explains 42,61% of the total variance and includes the variables SiO_2^{2+} , HCO_3^- , Na^+ , Ca^{2+} , Rb, Sr, Cl^- , SO_4^{2-} e Mg^{2+} .

The association (SiO_2^{2+} , HCO_3^- , Na^+ , Ca^{2+} , Rb, Sr) is tightly correlated with factor 1. This association characterizes the

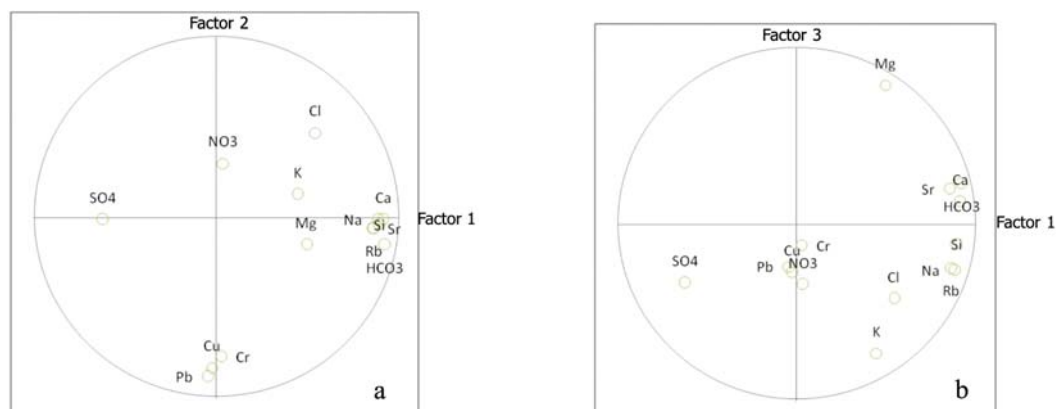

Fig. 4 a) Projection of the variables in the 1st factorial plan; b) Projection of the variables in the 2nd factorial plan

chemical composition of the water, whose origin may be found in the geology of the region, namely in the interaction water/rock. This association demonstrates the process of decomposition of the rock. The silicate minerals present in the granite are the main source of silica in the groundwater. The alteration of the granite is the main source of the presence of the ion HCO_3^- . The infiltration of the superficial waters containing CO_2 attacks aggressively the aluminum silicate minerals, such as the micas and the feldspar present, releasing cations like the Ca^{2+} e Mg^{2+} to the water and creating clay minerals. The consequences of this unsuitable dissolution are verified in an increase of the pH and the concentration of HCO_3^- in the groundwater [14]. The presence of sodium and calcium is due to the inconsequent dissolution of the plagioclases [15]. The ions Cl^- e Mg^{2+} present a moderate correlation with factor 1 and the ion SO_4^{2-} is correlated with the factor 1 of negative value, thus reflecting the hydrochemical classification obtained by the Piper diagram. The factor 1 shows clearly the interaction water/rock.

Factor 2 explains 17,33% of the total variance and includes the variables Cr, Cu e Pb.

The association (Cr, Cu, Pb) is tightly correlated with the factor 2. This factor may show the process of percolation of the soil. The hard metals in the soil can be present in primary and secondary minerals, precipitate, absorbed, in the soil solution or in microorganisms, plants and animals.

Factor 3 explains 14,00% of the total variance and includes the variables K^+ e Mg^{2+} .

The factor 3 explains the ion K^+ in opposition to the ion Mg^{2+} . The presence of the K^+ can be due to the dissolution of the muscovites and the orthoclase present in the granite. The enormous resistance of the K^+ to the alteration and its solidification in the clay minerals formed by the processes of alteration [16] may explain this factor.

Factor 4 explains 8,90% of the total variance and includes the variable NO_3^- .

The ion NO_3^- is tightly correlated with the factor 4. This factor characterizes the pollutant component of the water.

5. Conclusion

About the water quality in the granitic massif of the Gardunha mountain, namely in the area northeast area, it is important to refer to the fact that, through the physical and chemical analyses made in selected springs, at first sight very representative, all the waters are of sodium-bicarbonate type, being waters of very low mineralization, with TDS values equal or inferior to 42.3 mg/l.

The lithological nature of the Gardunha mountain, in its granitic sector, is a great supply of aluminum silicates with alkali and alkali muddy cations that by hydrolysis allows the release of silica, calcium, sodium and potassium. These are easily soluble in a moderate acid environment, going to the surrounding water. From the chemical attack to the minerals of the rocks result insoluble residues formed by silica and by minerals from the clay group.

The order of the abundance of the major cations and anions is the following: $\text{Na}^+ > \text{Ca}^{2+} > \text{K}^+ > \text{Mg}^{2+}$, $\text{HCO}_3^- > \text{Cl}^- > \text{SO}_4^{2-} > \text{NO}_3^-$.

The factorial analysis allowed studying the inter-correlation between the analyzed variables and establishing its distribution structure. 4 factors were obtained and they explain and identify the origin of the presence of ions in the underground water. The factor 1 reflects the signature of the interaction water/rock. The factor 2 materializes the percolation process of the hard materials of the soil. The factor 3 represents the dissolution process of the muscovites and the orthoclase present in the granite. The factor 4 has a pollutant feature materialized by the ion NO_3^- .

Acknowledgments The first author (Eric Mendes) would like to thank the Portuguese Foundation for Science and Technology and also Beira Vicente Lda. for funding the PhD grant (SFRH/BDE/33328/2008). Luis M. Ferreira Gomes and Eric Mendes would like to thank to CVRM-Centro de GeoSistemas for the facilities conceded and Paulo Carvalho also would like to thank to GEOBIOTEC for the facilities conceded.

References

- [1] RIBEIRO, L.: *Groundwaters in Portugal [in Portuguese]*. In: Ribeiro L, Medeiros A, Abrunhosa M (eds) Engineering groundwater manual, Groundfos, Lisboa, 2004, p. 5-18
- [2] MEDEIROS, A.: *Prospection, Investigation and Sizing of Groundwater Capitation [in Portuguese]*. In: Ribeiro L, Medeiros A, Abrunhosa M (eds) Engineering groundwater manual, Groundfos, Lisboa, 2004, p. 5-18
- [3] RIBEIRO, A., ANTUNES, M. T., FERREIRA, M. P., ROCHA, R. B., SOARES, A. F., ZBYSZEWSKI, G., ALMEIDA, F. M., CARVALHO, D., MONTEIRO, J. M.: *Introduction in the General Geology of Portugal [in French]*. Serv. Geol. Portugal, Lisboa, 1979, 114 p.
- [4] RIBEIRO, A., ALMEIDA, F. M.: Low Enthalpy Geothermal Resources in Mainland Portugal [in Portuguese]. *Geonovas, Rev. Assoc. Port. Geologos*, Lisboa, vol. 1, n° 2, (1981), p. 60-70.
- [5] INAG: *National Institut of Water [in Portuguese]*, Sistema Nacional de Informacao de Recursos Hidricos, <http://www.snirh.inag.pt/> Accessed Jan 2009
- [6] LENCASTRE, A., FRANCO, F. M.: *Hydrology Lessons [in Portuguese]*, Universidade Nova de Lisboa, Faculdade de Ciencias e Tecnologia, Monte da Caparica, 1984, 451 p.
- [7] WHO: *Guidelines for Drinking-water Quality, vol 1: Recommendations*, 3rd edn. WHO, Geneva, 2004, ISBN 92-4-154696-4.
- [8] RUIZ, F., GOMIS, V., BLASCO, P.: Application of Factor Analysis to the Hydrogeochemical Study of a Coastal Aquifer. *J. of Hydrology* 119:169-177, 1990, ISSN 0022-1694.
- [9] LAWRENCE, W., UPCHURCH, S. B.: Identification of Geochemical Patterns in Groundwater by Numerical Analysis. In: Saleem ZA (ed) *Advances in groundwater hydrology*. American Water Resources Association, USA pp 199-214, 1976
- [10] USUNOFF, E. J., GUZMAN, A. G.: Multivariate aAnalysis in Hydrochemistry. An Example of use of Fand Correspondence Analysis. *Groundwater Journal* 27:27-34, 1989, ISSN 1745-6584
- [11] JAYAKUMAR, R., SIRAZ, L.: Factor Analysis in Hydrogeochemistry of Coastal Aquifers- a Preliminary study. *Environmental Geology* 31:174-177, 1997, ISSN 1432-0495
- [12] CHAN-HO, J.: Mineral-water Interaction and Hydrogeochemistry in the Sankwang Mine Area, Korea. *Geochemistry Journal* 35:1-12, 2001
- [13] YAMMANI, S. R., REDDY, T. V. K., REDDY, M. R. K.: Identification of Influencing Factors for Groundwater Quality Variation Using Multivariate Analysis. *Environmental Geology* 55:9-16, 2008, ISSN 1432-0495
- [14] FREEZE, R. A., CHERRY, J. A.: *Groundwater*. Prentice-Hall : New Jersey, 1979, ISBN 0-13-365312-9
- [15] SAETHER, O. M., CARITAT, P.: *Geochemical Processes Weathering and Groundwater Recharge in Catchments*. A.A. Balkema, Rotterdam, 1997
- [16] GOLDICH, S. S.: A Study in Rock Weathering. *The Journal of Geology* 46:17, 1938, ISSN 0022-1376.

Libor Izvolt – Jan Kardos *

INTELLIGENT COMPACTION TECHNIQUE AS A TOOL OF OBJECTIVE AND EFFECTIVE APPLICATION OF GEOSYNTHETICS

The paper focuses on evaluation of the current state of designing and realization of railway substructure layers on modernized Slovak railway tracks with the emphasis on an effective use of geosynthetic products. The presented method of intelligent compaction may significantly increase efficiency of design and realization of construction layers with the objective use of geosynthetics and other adjustments at various geological conditions of subgrade.

1. Introduction

Intensive modernisation of railway tracks belonging to Trans-European railways (TER) has been realized in Slovakia at present. A technical level of these modernized tracks (in Slovakia they are represented by corridors No. IV, V, VI and the North – South inter-connection of the corridor IX with the total length of 1 033 km) has to meet international requirements based on European Agreement on Main International Railway Lines (AGC) and European Agreement on Important International Combined Transport Lines and Related Installations (AGTC). The modernisation of the railway tracks improves their technical parameters, namely the adaptation of the railway substructure to the axle force of 225 kN and the speed of 60 km/h (with the outlook for 200 km/h). This increase of the technical level of the railway substructure presents a considerable problem because the tracks are in different technical conditions and are built in various geological conditions of subgrade. The design of a sleeper subgrade construction, i.e. its structure and dimensions of layers as well as the determination of minimum values of chosen physical and mechanical properties of the applied materials and components has to be based on:

- results of an engineering geological (EG) exploration in those places where the modernized track will not be built on the original earth structure;
- evaluation of current technical conditions of the sleeper subgrade in those places where the modernized track will remain on its original earth structure;
- given technical requirements for the railway track construction, particularly Z11 [1] a TNZ 73 6312 [2].

At present the main problem of a sleeper subgrade design is an insufficient EG exploration. Its main disadvantage is its point-by-point character (boreholes or field soundings realized on the

railway track axis in the distance of 100 – 250 m, sometimes more than 250 m). This type of the EG exploration cannot reflect sufficiently real conditions of the sleeper subgrade construction or railway substructure bottom layer in both, longitudinal and transversal directions. Project engineers are aware of this fact. Regarding their responsibility for a design of a reliable railway substructure construction and its bottom layer, they are often forced to design a construction with a high degree of safety by which they eliminate insufficient input data from the EG exploration. An example of such an ineffective (unsubstantiated) use of building materials is an extensive use of geosynthetics as can be seen in Tab. 1 which presents consumption of geosynthetic products on modernized/reconstructed track and station sections.

Some types of geosynthetic products still present unconventional products in our conditions, particularly when they are compared to the sleeper subgrade structure of track sections built in the past (on some corridors often more than 100 years ago). In some cases, insufficient experience with their application (not only in the Slovak Republic) together with insufficient standard specification documentation make it impossible to evaluate objectively the necessity of their application. It is important to mention that the modernized tracks given in Tab. 1 copy the original earth structure in ca 90 % of the track sections length. This original earth structure and its bottom layer may have due to long-time operation sufficiently reduced deformability which means that it is not necessary to design a railway substructure with built-in geosynthetics.

After identifying the above mentioned problems we will focus on an alternative approach to a design of railway substructure layers with the emphasis on elimination of non-objective and ineffective use of geosynthetics. One of possible steps towards more efficient use of geosynthetics in the railway substructure is the use

* Libor Izvolt¹, Jan Kardos²

¹ Department of Railway Engineering and Track Management, Faculty of Civil Engineering, University of Zilina, Slovakia,
E-mail: libor.izvolt@fstav.uz.zilina.sk

² Vahostav – SK a. s., Zilina, Slovakia

An overview of amount and approximate costs of geosynthetics used on chosen SR sections [3], [4]

Table 1

Track or station section / project company	Length of section / length of railway line	Original earth structure of the track sections length	Amount of geosynthetics / Price of geosynthetics			Total amount / Price of building-in	Total price / Price of geosynthetics
			geogrids	geotextiles	geo-composites		
Žilina - Krásno nad Kysucou	18.869 km	ca 96 %	140,000 m ²	230,000 m ²	45,000 m ²	415,000 m ²	155,000,000 €
Sudop Košice, a.s.	42.206 km		675,000 €	270,000 €	260,000 €	190,000 €	1,395,000 € (0.90 %)
Žilina - Teplička - vriad. stanica	6.300 km	ca 87 %	85,000 m ²	5,000 m ²	0 m ²	90,000 m ²	125,000,000 €
Prodex, spol. s r.o.	37.158 km		380,000 €	5,000 €	0 €	90,000 €	475,000 € (0.38 %)
Nové Mesto nad V. - Zlatovce	17.457 km	ca 78 % without tunnel 88 %	280,000 m ²	450,000 m ²	5,000 m ² & 30,000 m	735,000 m ² a 30,000 m	255,000,000 € ¹⁾
Reming Consult, a.s.	36.720 km		1,900,000 €	800,000 €	3,800,000 €	400,000 €	6,900,000 € (2.71 %)
Trenčianska Teplá - Beluša	20.409 km	ca 95 %	420,000 m ²	505,000 m ²	20,000 m ²	945,000 m ²	290,000,000 €
Reming Consult, a.s.	49.839 km		1,450,000 €	525,000 €	40,000 €	540,000 €	2,555,000 € (0.88 %)
Zlatovce - Trenčianska Teplá	11.952 km	ca 91%	200,000 m ²	560,000 m ²	25,000 m ²	785,000 m ²	260,000,000 €
Reming Consult, a.s.	32.700 km		625,000 €	480,000 €	60,000 €	330,000 €	1,495,000 € (0.58 %)
Total for evaluated track or station sections	74.897 km 198.623 km	ca 90 %	1,125,000 m² 5,030,000 €	1,750,000 m² 2,080,000 €	95,000 m² & 30,000 m 4,160,000 €	2,970,000 m² & 30,000 m 1,550,000 €	1,085,000,000 € 12,820,000 € (1.18 %)

¹⁾ the price includes a railway tunnel with the length of 1 740 m which represents over 30 % of given costs

Note: The prices are quoted without VAT and the amounts are only approximate. The costs of geosynthetic products for one metre of a double-track are in average ca 130 € without VAT.

of named intelligent compaction technique. It enables us to localise such critical places where the potential application of geosynthetics may make a major contribution. At the same time the intelligent compaction technique enables more effective building of materials and components into the railway substructure and its bottom layer (e.g. by increasing a synergetic effect between reinforcing geosynthetics and aggregate) and thus it increases deformation resistance and durability of the construction.

2. Intelligent Compaction Technique

Recompaction of railway substructure layers due to the operation of a track and bottom layer consolidation due to the increased geostatic embankment loading are the main reasons of geometrical position disintegration and track distortion. Compaction is the easiest and most effective technology used for increasing mechanical efficiency of railway substructure layers and its bottom layer consisting of various types of soils. The results of quality compaction are such changes in a soil structure which reduce its settlement to minimum even during long-time operation loading. To reach these changes in the soil structure, it is necessary to apply such force actions during the compaction process which will exceed its shear strength threshold. This will change the soil structure, reduce space between soil particles, and reduce pore volume (it will increase bulk density of soil). The equipment which is used for compaction is represented mainly by flat-surfaced compaction rollers, which can be divided according to the compaction method into static, vibratory, oscillatory, and nutatory.

As for quality of cohesive and non-cohesive soil compaction, flat-surfaced vibratory rollers were the most effective for a long time. Compaction technique producers' continual effort was to make use of more progressive and sophisticated systems which enabled high-quality and more effective (as for finances and tech-

nology) compaction of soil with various physical and mechanical properties. The final result of compaction technique producers' effort was the production of named "intelligent rollers" which automate several controlling processes of compaction with the use of mutually interconnected systems (Fig. 1).

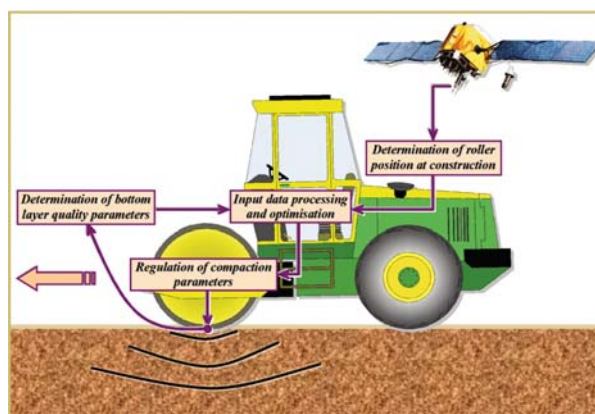

Fig. 1 System of intelligent roller [5]

The first required system component of intelligent compaction technique is continual determination of the achieved quality of a compacted bottom layer (construction layer) during compaction. It is possible to quantify the compaction quality parameter by various parameters of conventional diagnostic methods, e.g. D (compaction degree determined by bulk density test), PS (standard Proctor compaction test), I_d (relative density index determined by bulk density test), M_z (compaction degree determined by static plate loading test), E_0 (deformation module determined by static plate loading test), E_r (deformation module determined by dynamic plate loading test), CBR (bearing capacity determined by California

An overview of compaction technique producers and parameters describing a compacted bottom layer condition

Table 2

Producer of compaction technique (state - year of development)	System name / GPS (yes/no)	Designation of a parameter and a unit of parameter	Determination of a parameter describing a bottom layer condition	Determined correlations of a bottom layer quality parameter with conventional diagnostic methods
AMMANN - CASE (SUI - 1998) [6]	ACE Ammann Compaction Expert (yes)	k_B MN/m	The parameter k_B (dynamic reaction module) is expressed as a ratio between the load affecting the roller and the decline of the roller which is determined indirectly via accelerometer.	The measured value k_B is almost identical with the deformation module E_{v2} from the static loading test according to DIN 18196.
BOMAG (GER - 2000) [7]	BVC Bomag Vario Control (yes)	E_{vTB} MN/m ²	The parameter E_{vTB} (vibration rigidity module) is determined from the tangent of the curve of contact load dependence on bottom layer deformation measure (input parameters are determined indirectly via accelerometer).	The measured value E_{vTB} correlates well with the deformation module E_{v2} from the static loading test according to DIN 18196.
CATERPILLAR (USA - 2006) [8]	CAT Compaction Monitoring System (yes)	CMV or energy of roller drive	The CMV parameter is defined below. The parameter of drive energy of a roller represents mechanical energy needed for the roller drive which is changed according to the height of material wave pressed by the compaction roller and the height of pressed wave depends on bottom layer quality.	The correlation dependence between CMV (compaction meter value) and DCP (dynamic cone penetrator) which achieved good parameters [8].
DYNAPAC (SWE - 2003) [9]	DCA Dynapac Compaction Analyzer (yes)	CMV Compaction Meter Value	The non-dimensional CMV parameter developed by the company. Geodynamic from 1978 is based on the ratio between the first harmonic amplitude of acceleration and acceleration amplitude of double frequency.	The non-dimensional value CMV correlates well with the deformation module from the static loading test [10].
VOLVO - INGERSOLL RAND (USA - 2008) [11]	- (no)	CMV Compaction Meter Value	The non-dimensional CMV parameter developed by the company. Geodynamic from 1978 is based on the ratio between acceleration amplitude of double frequency and the first harmonic amplitude of acceleration.	The non-dimensional CMV value correlates well with the deformation module from the static loading test [10].
HAMM (GER - 2004) [12]	HCQ Hamm Compaction Quality (yes)	HMV Hamm Meter Value	The non-dimensional parameter similar to CMV developed by the Swedish company Geodynamic (details in [12]).	The non-dimensional HMV value correlates well with the deformation module from the static loading test E_{v2} and the CMV value [12].
SAKAI (JP - 2002) [13]	CIS Compaction Information System (yes)	CCV Compaction Control Value	Non-dimensional parameter similar to CMV based on the ratio of acceleration amplitudes sum of 0.5-, 1.5-, 2- and 3-multiple of frequency and acceleration amplitudes sum of 2.5 and 3.5-multiple of frequency.	The CCV value correlates well with the bulk density of compacted material [13].

bearing ratio test), etc. Determination of the compaction quality parameter via compacting rollers is a more complex problem since soils are defined as non-homogeneous materials with a considerable difference in their physical and mechanical properties. Soil diagnostics has to be realized continually and, at the same time, a really (conventional diagnostic methods are point in their character) during compacting process (the speed of compaction rollers during compaction is approximately 2 - 6 km/h). Important compaction technique producers, for example, AMMANN, BOMAG, CATERPILLAR, DYNAPAC, VOLVO, HAMM a SAKAI have a different approach to the determination of a bottom layer condition during compaction. However, mutual correlation with the conventional methods of compaction quality diagnostics has reached satisfactory significance in all parametric studies (Tab. 2).

The second required system of the intelligent compaction technique is monitoring and recording of a coordinate position of the roller at a given construction. It means that after identifying the quality parameter value of the bottom layer, the location of the roller is recorded with a satellite GPS signal in real time. Then these position coordinates are matched with the monitored parameter value of the bottom layer. Accuracy of location determination of the compaction roller is usually up to 0.10 m [5]. At the same time the location system interconnects the geometrical design of the construction as a vector 3D model with the controlling of con-

struction machines without necessity of demanding, expensive, and detailed geodetic surveying of the construction. When using construction machines with GPS (grader and compaction roller) it is possible to save 20 - 50 % of costs needed for geodetic stake-out of the construction. An example of a compaction map which is a standard graphic output of intelligent rollers is given in Fig. 2. Based on this map it is possible to localise vertical non-homogeneities of the bottom layer in the whole compacted plane. Then compaction rollers are able to optimise parameters for the next roller pass.

Another required system component of the intelligent compaction rollers is a computer in which the information about bottom

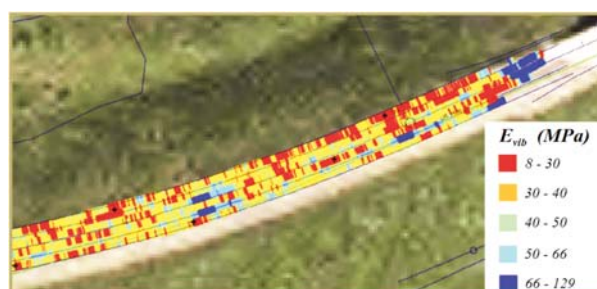

Fig. 2 An example of a compaction map [7]

layer conditions and roller positions are continuously saved (a compaction map). All gathered information is processed with the installed software in order to optimise compaction parameters of the roller. Optimisation of compaction parameters can be linear, non-linear or dynamic (all details are given in [14]). It presents identification of such values of variable compaction parameters which provide the required definiteness of result values in the process of the following compaction.

Elimination of non-homogeneities works thanks to the third required system component of the compaction technique which is equipment for continuous transformation of compaction parameters (most often it is the change of compaction frequency, amplitude and centrifugal force). The result of the mutual interconnection of system components is the fact that intelligent compaction rollers regulate automatically variable vibration, oscillation, and nutation parameters with the criterion of the minimum input energy for achieving the maximum compaction effect with regard to previous compaction effects (Fig. 3). After supplying energy necessary for the compaction process, the bottom layer conditions are determined again, and then, after evaluation of changes and new conditions, we return to the beginning of the optimisation process again with new input values. Simultaneously, it is necessary to monitor the relation to the final state of compaction (required or limit) during

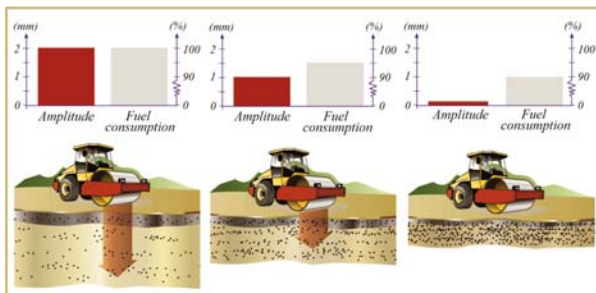

Fig. 3 Optimisations of compaction parameters - controlled vibration

this process, while meeting the criterion of minimum compaction energy. The result of compaction with intelligent rollers is an achievement of a remarkably more homogeneous layer (which will be reflected on its longer durability) while using minimum compaction energy.

3. The use of Intelligent Compaction Technique in Connection with Objective and Effective Application of Geosynthetics

Long-term, costly, and technically problematic and unsuitable certification process of geosynthetic products (it is necessary for a producer or distributor of geosynthetics to obtain a licence issued by Slovak Railways (SR) before its application into track constructions of SR) causes that mainly geosynthetic materials with a wide range of use and a large amount of consumption are applied in Slovak Railways. These are according to Tab. 1 mostly geotextiles (ca 55 %), geogrids (ca 40 %) a geocomposites (ca 5 %).

3.1 Objectivisation and effective application of geotextiles

Geotextiles are applied on SR tracks mainly in order to assure separation (prevention of two granulometrically different layers from interblending) and filtration (prevention of suffosion and colmatage of particles between layers) of construction layers. As for filtration, an impulse for geotextile application is not meeting a Terzághi's filtration criterion. Thus a project engineer has to be acquainted with a grain size analysis (determined by a sieve test and density analysis) when making a decision about the application of geotextile. This assumes the realization of the EG exploration in the axis of the future track (in the case of modernisation it can be either in the axis or out of the axis of the existing track), as well as determination of embankment material (it is necessary to choose appropriate borrow pits, gravel pits and stone pits) and subbase material (subbase material has a defined required grading curve in TNZ 72

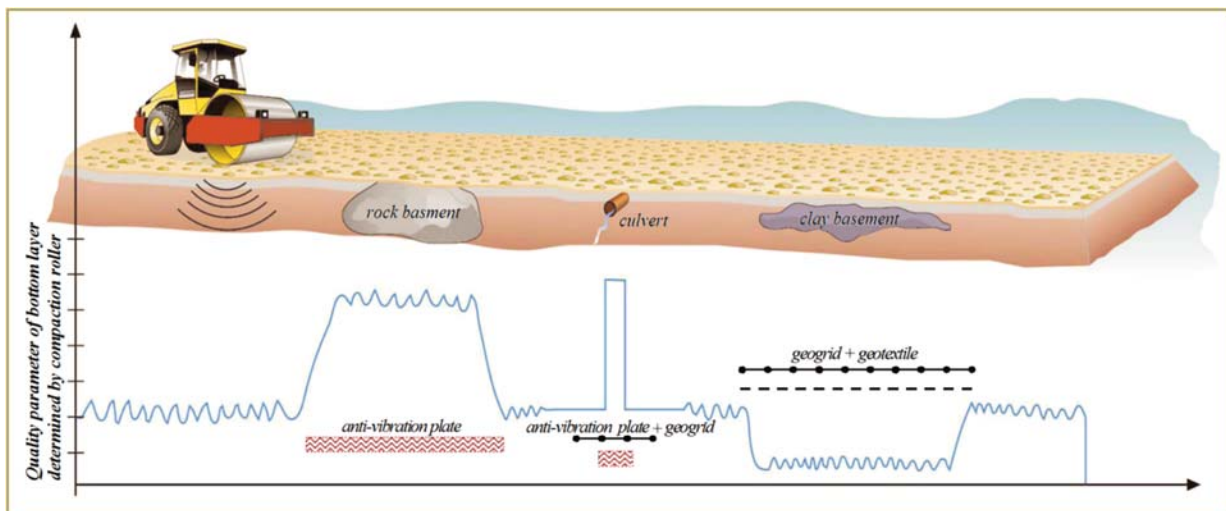

Fig. 4 An example of objectivisation of geosynthetics application during intelligent compaction [15]

1514). The *EG* exploration provides material samples of the embankment bottom layer (in the case of constructing a track on a new earth structure) or the subgrade surface (in the case of track built on the original earth structure) by a drilling ring with core drilling. The problem of objective planning of geotextile application is input data, particularly (a) an insufficient or incomplete *EG* exploration of the railway substructure (samples taken in the distance of every 250 m or more are not representative, mainly in hard geotechnical conditions), (b) assumptions connected with material basis for the embankment (constructors may use a different embankment material from the one presupposed in the project documentation), (c) wide range of grading curve of aggregate for the subbase (the supplier of aggregate can mix aggregate of various grading curves within the given curve limits according to *TNZ 72 1514*). Evaluation of criteria for the application of a particular geotextile type directly during the realization of the construction, for example, via a geotechnical consultant, could eliminate geotextile usage remarkably. It could also help to objectivise places where its application is of real and fundamental importance. The intelligent compaction rollers could localise (during the compaction process based on a considerable decrease of the parameter monitoring compaction quality (Fig. 4)) also those places which have not been presupposed or found out on the level of the open embankment bottom layer or subgrade surface during the *EG* exploration, e.g. hidden local beds of plastic saturated fine-grained soils which have not been revealed in the point *EG* exploration. The application of geotextile in places with extremely low quality of the bottom layer determined during compaction may lead to elimination of occurrence of increased suffusion and colmatage and thus it can increase durability of the construction as a whole. The construction durability increase may also be influenced by controlled vibration which enables to regulate such parameters of "sensitive" compaction that will not mean any risk of damage for the applied geotextiles (it is possible to carry out a simple compaction test to determine these target/limit parameters of compaction). The intensive compaction can subsequently be applied in its full range only in higher construction layers where compaction cannot damage the applied geotextile.

3.2 Objectivisation and effective application of geogrids

Geogrids (biaxial and triaxial) are to have mainly a reinforcing function in the railway substructure, its bottom layer or a track bed. It means that they are to increase deformation resistance in those places where it is not possible to achieve the required minimum values only by compaction. When designing a construction with a geogrid, in the project phase it is necessary to know coefficients *TBR* (*Traffic Benefit Ratio* – a coefficient expressing the increase of layer durability from the point of view of its reinforcement) or *BCR* (*Base Course reduction Ratio* – a reduction coefficient of layer thickness from the point of view of its reinforcement) which are possible to reach for the given geogrid, aggregate, and place of application under certain technological conditions [16], [17]. However, determination of the *TBR* and *BCR* parameters would require an extensive experimental measurement on model constructions with dynamic loading (pulsator), or directly in-situ (requirements for

experimental measurements are not defined). This is one of the reasons why it is not obligatory to define these parameters in *SR* licences. The *SR* licences for a particular geogrid and given local conditions specify a layer structure (in this case only a subbase structure) with the guaranty of certain reachable equivalent deformation module values from a static plate loading test (*PLT*) on the surface of this construction. Reaching the required equivalent deformation module values is according to an analysis realized in [16] often wrongly attributed only to a reinforcing effect of the geogrid, while an important reason of the deformation resistance increase of a reinforced construction is also high-quality compaction of construction layer material. The compaction quality (presented, for example, by the compaction measure M_z from the *PLT*) should be a decisive parameter for the evaluation of the construction quality and its required values for a given reinforced construction should be specified in *SR* licences [19].

The quality parameter of a compacted layer determined by intelligent compaction rollers has, on the contrary to the parameters from the *PLT*, better utterance value, particularly for these reasons:

- character of loading which converges better to the character of real dynamic loading caused by running of a train set (the frequency of compaction vibratory rollers is most often 25 – 45 Hz, with the amplitude 0.4 do 2.0 mm during the compaction),
- amount of loading (the weight of a roller is usually 7.5 – 27 t which means static linear loading 20 kN.m^{-1} – 80 kN.m^{-1}),
- area of loading (width of a roller drum is most often 1.60 – 2.20 m).

On the one hand, intelligent rollers for objective application of geogrids enable us to localise efficiently places with a considerable deformation resistance reduction where the application of geogrid may have its justification and, on the other hand, they make it possible to build in the geogrid more effectively (because of reaching a better compaction). Here it is important to emphasize that for the realization of more effective compaction and thus reaching a higher deformation resistance, it is necessary for the aggregate and applied geogrid to have suitable physical and mechanical properties (geogrid should have mainly high complex rigidity and gravel should have mainly high compression strength) and shape characteristics (shapes of tensile components for geogrids and shape index, roughness, and angularity for aggregate) and at the same time the geogrid cannot be damaged during the compaction. This condition, as well as the condition of the required toothing and fixation of compacted material particles in geogrid apertures in order to create a named interlock effect (details given in [16], [17], [18]) is best fulfilled by named continuous geogrids with crushed sharp-edged aggregate of a suitable granulometric composition. These geogrids are the most suitable and recommended for application into reinforced layers. The area application of such a geogrid also out of places with non-homogeneous bottom layer localised by intelligent rollers (i.e. diagnostics procedure via the *PLT*) would theoretically mean a deformation resistance increase on the whole area with the applied geogrid. In this case the elimination of non-homogeneity would not be achieved effectively, but (as a consequence of various compaction processes) only in higher construction layers. In the case of geogrid application it is necessary to take into con-

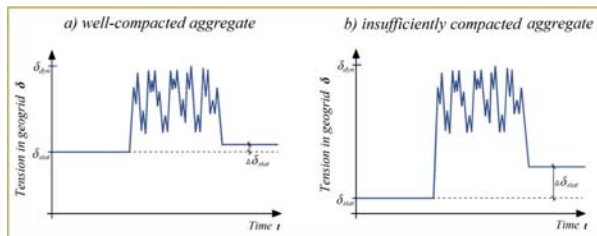

Fig. 5 An illustration of tension development in geogrid during loading

sideration also the fact that potential reinforcing efficiency decreases with the increasing depth of geogrid placement. This is the reason why present worldwide research concentrates on application of geogrid into higher construction layers, particularly between a subgrade surface and track bed. If good aggregate compaction is reached, a static prestress value of geogrid δ_{stat} is higher. It means that the geogrid transmits the loading more effectively and there is no remarkable deformation of the geogrid (which further causes a decline of the construction after the dynamic loading caused by train traffic δ_{dyn}) as it is in the case of insufficient compaction (the importance of aggregate compaction above geogrid is characterised in Fig. 5). The minimum value of aggregate compaction which is necessary to take into consideration for the effective application of geogrid is on the level of 95 % of the maximum compaction. Intelligent compaction rollers make it possible to reach this required compaction value.

3.3 Objectivisation and effective application of anti-vibration plates

Anti-vibration, or under-ballast plates are used in the railway substructure layers for reduction of mechanical vibration waves emitted by traffic. These are emitted mainly in the case of a contact of two rigid structural parts of the railway track (Fig. 6). The railway track construction should be designed and built in order to have a compressibility coefficient C_z reaching a certain minimum value

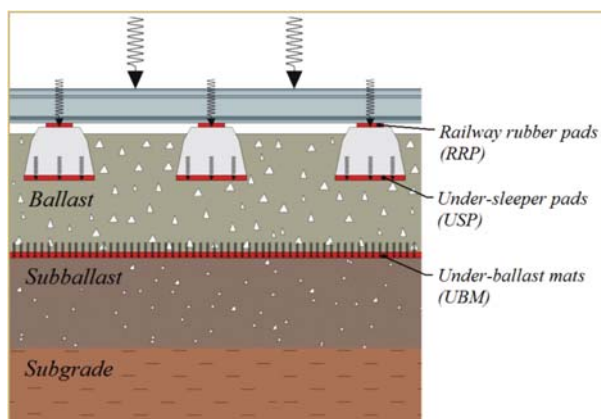

Fig. 6 An example of antivibration plates usage

under the loading area of sleepers, and at the same time it should be homogeneous. It is also possible to determine a compressibility coefficient value C_z from deformation resistance requirements based on the $PLT (E_{ekv})$ for the bottom layer or for individual railway substructure layers. In those places where the required compressibility coefficient value is exceeded, it is possible to use anti-vibration plates with various parameters according to given requirements. The main parameters determining elasticity characteristics of anti-vibration plates are static (equivalent of compressibility coefficient) and dynamic area rigidity. When using anti-vibration plates, the intelligent compaction technique may also have a remarkable contribution, either in the accurate localisation of anti-vibration plate application (Fig. 4) or when verifying the parameters of construction built in this way.

4. Conclusions

Intelligent compaction technique represents a significant means for reaching technically remarkably more effective railway track. Except for a general contribution, intelligent compaction has also other advantages for objective and effective application of geosynthetics, particularly:

- accurate and reliable localisation of vertical non-homogeneities of the bottom layer based on which it is possible to optimise a type, characteristics and amount of the applied geosynthetics (Fig. 3),
- “sensitive” compaction of aggregate above geotextile,
- high-quality compaction of aggregate above geogrid in order to reach the required dynamic toothing and increase the efficiency of geogrid,
- localisation of places with a high compressibility coefficient in which it is possible to design anti-vibration plate with the required parameters,
- direct verification of results of geogrid and anti-vibration plate application,
- economic impact caused by the application of a smaller amount of geosynthetics,
- ecological consequences following from the application of a smaller amount of geosynthetics, (geosynthetics is made from petroleum products and imported from abroad via truck transport, etc).

In spite of many advantages which compaction rollers offer, there have not been realized any studies that would monitor a correlation relation between parameters of bottom layer quality defined in ZSR Directive S4 [20] and parameters detected by compaction rollers (Tab. 2). Thus the use of these parameters does not have such importance in practice as it could have. This is the reason why it is still necessary to verify the quality of a compacted structure during its construction only with conventional parameters from the PLT in accordance with the ZSR Directive S4 [20]. Involving intelligent rollers into complex problematics of a railway substructure and bottom layer design would make the construction design more accurate during its own realization. This would save costs considerably in the case of an insufficient or ineffective geotechnical exploration in pre-project preparation of the construction. It

would also help to specify designers' assumptions in a project phase which would lead to a more effective design of the construction based on real geotechnical conditions. From this point of view it seems to be very suitable and useful to establish a status of a geological consultant who would be responsible for a design of the railway substructure and bottom layer [21] during preparation, designing and realization of the construction. At present a similar status of a consultant is used effectively, for example, in connection with tunnel constructions.

Problematics described in this paper reveals many activities which are necessary to perform in order to design and construct an effective railway substructure and its bottom layer. Firstly, it is verification of the correlation between bottom layer quality parameters diagnosed by intelligent compaction rollers and conventional diagnostic methods according to ZSR Directives. Based on these correlations it would be possible to reduce the use of conventional diagnostic methods whose main disadvantages are presented in this paper. Objectivisation of geosynthetics application provided by intelligent rollers thanks to continual and area diagnostics is also very important. As for a reinforcing function of geogrids, intelligent rollers enable us to verify their efficiency in various constructions since the variability of measure and development of loading is almost identical to a real traffic loading. After the correlation analysis it

is also possible to use intelligent rollers for an effective design of anti-vibration plates, particularly when using a parameter of dynamic area rigidity. Subsequently after the realization of a comparison test, it will be necessary to update several normative documents in order to prevent the use of intelligent compaction technique from encountering legislation problems and in order to make a full use of all technical possibilities they offer. Apart from this, it is desirable to re-evaluate the requirements for issuing SR licences for geogrids in the way that values of static deformation modules from the *PLT* would be completed with values of compaction quality and the contribution from geogrid application in the railway track construction layers would be specified by *TBR* or *BCR* coefficients (it is possible to realize their quantification with intelligent rollers, as well).

Acknowledgement:

The paper is a partial result of the project *VEGA 1/0474/09: Considering the new conditions of railway track structure design and examination from the point of view of non-traffic load.*

This contribution is the result of the project implementation: *Centre of excellence for systems and services of intelligent transport, ITMS 26220120028 supported by the Research & Development Operational Programme funded by the ERDF.*



Agentúra
Ministerstva školstva, vedy, výskumu a športu SR
pre štrukturálne fondy EÚ

"Podporujeme výskumne aktivity na Slovensku/Projekt je spolufinancovaný zo zdrojov EU."

References

- [1] Predpis ZSR Z11: *General Principles and Technical Requirements for Modernisation of Railway Line with Track Gauge 1.435 mm*, ZSR : Bratislava, 02/2001 (in Slovak).
- [2] TNZ 73 6312: *Designing of Construction Layer of Railway Subgrade*, GR ZSR : Bratislava, 08/2005 (in Slovak).
- [3] KARDOS, J. et al.: *Tender Price Quotations for Modernisation of Railway Lines in Slovak Republic*, VAHOSTAV – SK, a.s. : Zilina, 2008, 2009, 2010 (in Slovak).
- [4] *Tender Documentation for Modernisation of Railway Lines in Slovak Republic*, 2008, 2009, 2010 (in Slovak).
- [5] POKORNY, J., VAVERKA, M., KASPAREK, J.: Technology of Intelligent Vibratory Rollers and their Exploitation and Interconnection, In: *Stavebni technika* 1/2009. Available in: <http://stavebni-technika.cz/pdf/743.pdf> (in Czech).
- [6] ANDEREGS, R., DOMINIK F., KAUFMAN, K.: *Compaction Monitoring Using Intelligent Soil Compactors*, Proc. of GeoCongress 2006, Geotechnical Engineering in the Information Technology Age, American Society of Civil Engineers, 2006. Available in: www.intelligentcompaction.com/downloads/PapersReports/Ammann_Anderegg_Compaction%20Monitoring%20Using%20Intelligent%20Soil%20Compactors.pdf.
- [7] DENNISON, D.: *Bomag Americas, Bomag Fayat Group, firm presentation*. Available in: www.intelligentcompaction.com/downloads/Presentation/NYIC_Open%20House_Bomag.pdf
- [8] PETERSEN, L., PETERSON R.: *Intelligent Compaction and InSitu Testing at Mn/DOT TH53, Final Report*, Minnesota Department of Transportation : Minnesota, 05/2006. Available in: www.lrrb.org/PDF/200613.pdf
- [9] LUNDHAL, L.: *Intelligent Compaction*, Company presentation, 08/2008. Available in: www.infraestructura.org.co/memoriaseventos/segundoencuentronacionaldepavimentos/INTELLIGENTCOMPACTION-DYNAPAC.pdf

- [10] BOUAZZA, A., KODIKARA, J., RARKER, R.: *Enviromental Geotechnics*, Rotterdam, 1997, ISBN 9054109033. Available in: www.books.google.sk
- [11] MOONEY, M., ADAM, D.: *Vibratory Roller Integrated Measurement of Earthwork Compaction: An Overview*, In: FMGM 2007: Seventh International Symposium on Field Measurements in Geomechanics, Boston, 2007. Available in: http://control.mines.edu/mooney/index.php?option=com_docman&task=doc_download&gid=6
- [12] RIMSTEDT, M.: *Uppföljning av barighet och deformationsutveckling av terminalytor vid inventering och nybyggnad i Goteborgs Hamn*, Examensarbete inom civilingenjorsprogrammet Vag och vattenbyggnad, Goteborg, 2006. Available in: <http://documents.vsect.chalmers.se/CPL/exjobb2006/ex2006-031.Pdf>
- [13] RAKOWSKI, S.: *Intelligent Compaction for Soil and Asphalt*, Sakai America Inc. Available in: http://www.eerc.iastate.edu/events/2009icwkshp/9_Sakai.pdf
- [14] POKORNY J., VAVERKA, M., KASPAREK, J.: Controls and Automated Systems of Compaction Technique Control, In: *Stavebni technika*, No. 4, 2007. Available in: <http://stavebni-technika.cz/pdf/452.pdf> (in Czech).
- [15] SIEKMEIER, J.: *Intelligent Compaction Mn/DOT Demonstrations, Iowa Geotechnical Workshop*, Ames, 12/2005. Available in: http://www.dot.state.mn.us/materials/re-searchdocs/iowa_geotech_johns_revised.pdf.
- [16] KARDOS, J.: *Exploitation of Geosynthetic Components in Track Bed Structure*. Dissertation thesis, Zilina, 2008 (in Slovak).
- [17] IZVOLT, L.: *Railway Subgrade - Loading, Diagnostic, Designing and Building of Construction Layers of Earthwork Structure*. EDIS : Zilinská univerzita, No. 2, 2008, p. 324, ISBN 978-80-8070-802-3 (in Slovak).
- [18] IZVOLT, L., KARDOS, J.: Parameter von Geogittern und ihr Einfluss auf deren Wirksamkeit im Eisenbahnunterbau. *Eisenbahntechnische Rundschau*, April 2010 - 59. Jahrgang, pp. 176-185, ISSN 0013-2845.
- [19] IZVOLT, L., KARDOS, J.: *Application of other Chosen Parameters in Sleeper Subgrade Dimensioning*. In: 4. Forum kolajovej dopravy. Bratislava, 2008 (in Slovak).
- [20] *Predpis ZSR S4 Railway subgrade*. Nakladatelstvi dopravy a spoju : Praha, 1988 (in Czech).
- [21] ROZSYPAL, A.: *Importance of the Geotechnical Consultan 's Activities in Railway Corridors Modernization* In: 4. Forum kolajovej dopravy, Bratislava, 2008 (in Czech).

Jozef Hrbcek – Vojtech Simak – Ales Janota *

USING PREDICTIVE CONTROLLER TO CONTROL A NONLINEAR SYSTEM

This paper engages in the Model Predictive Control of an Air Pressure system. The Air Pressure system includes a pneumatic and an electronic part. The model of the system was created using a tool for systems identifications. Since the system is nonlinear we can use the model linearization and set the constraints to create the Model Predictive Controller in MATLAB environment. The connectivity between PC and the air pressure system is realized by I/O card MF624. We provided the stability test as well. The PID controller was also designed to compare the results with those obtained from the Model Predictive Controller of the mentioned Air Pressure control system.

1. Introduction

Predictive control is based on discrete or sampled models of processes. The term “Model Predictive Control” denotes a class of control methods having a set of common properties: a mathematical model of the control system that is used for prediction of the future controlled output, known future trajectory of the required quantity, calculation of sequence of future control actions involving minimization of a proper cost function (usually quadratic) together with future trajectories of control increments and control deviation. Only the first proposed control action is performed and the whole minimization procedure is repeated in the next sampling period again. Usability of predictive control algorithms is quite wide and quality of control is usually higher than in the case of PID-controllers. They are applicable to unstable, multidimensional processes or processes with transport delay or nonlinear systems and compensate effects of measurable and non-measurable failures [1]. The air pressure system is also such a system since a proper algorithm must be used to control the pressure in air pressure system. To make a design of the predictive controller possible the existing air pressure system must be identified first using methods for system identification.

2. Air pressure system

The compressor is a small 12V powered device. A pneumatic piston is added at the compressor, whereby the output parameter (pressure) is changing. To decrease the air pressure continuously could be possible using a special electronic operating valve. In our system the electromagnetic valve works with discrete control (open/close) to decrease the pressure in air pressure system. An air tank increases the space for air in the pneumatic system.

The electronic part of the system is centralized in a box. This box incorporates the pressure sensor, protection against excess of pressure, manual switching, LED control and manometer. The overall arrangement of components of the air pressure system is shown in Fig. 1.

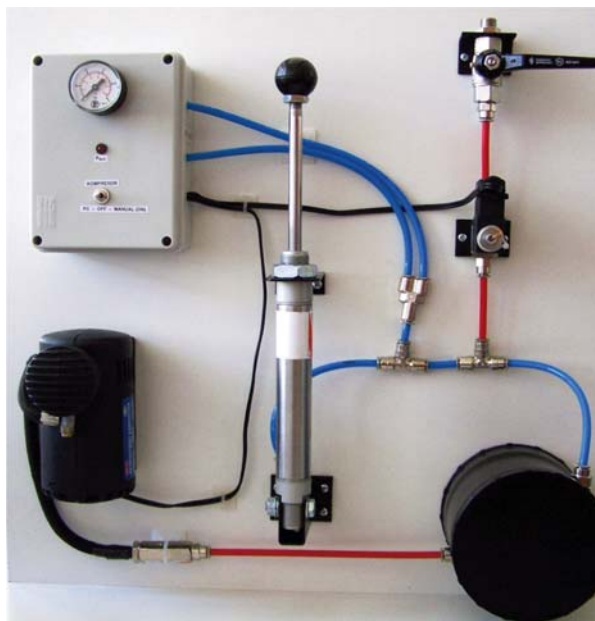

Fig. 1 Air Pressure system

The pneumatic piston can be used to cause a disturbing variable. In the common operation the pneumatic piston is in the high

* Jozef Hrbcek, Vojtech Simak, Ales Janota

Department of Control and Information Systems, Faculty of Electrical Engineering, University of Zilina, Slovakia,
E-mail: jozef.hrbcek@fel.uniza.sk

position. First, we can only increase the pressure by pressing the piston; next we can change the pressure inside the system of any size as well. The manual valve (in the upper right corner in Fig 1.) can be used only to decrease the pressure. The pressure inside the system is the output value $y(k)$. The current pressure in the system is sensed by pressure sensor MPX4250AP. The control variables affect the compressor and electromagnetic valve from I/O card MF624 through DC converter.

2.1. Constraints

In many control applications the desired performance cannot be expressed solely as a trajectory following problem. Many practical requirements are more naturally expressed as constraints on process variables. There are three types of process constraints: Manipulated Variable Constraints: these are hard limits on inputs $u(k)$ to take care of, for example, valve saturation constraints; Manipulated Variable Rate Constraints: these are hard limits on the size of the manipulated variable moves $\Delta u(k)$ to directly influence the rate of change of the manipulated variables; Output Variable Constraints: hard or soft limits on the outputs of the system are imposed to, for example, avoid overshoots and undershoots [7]. We use the Output constraints and Manipulated Variable Constraints.

2.2. Model linearization

In some cases the non-linear model can be transformed to linear one utilizing adequate transformation. For example: consider a process described by the following state description:

$$x(t + 1) = f(x(t), u(t)), y(t) = g(x(t)), \tag{2-1}$$

The method consists of searching states and outputs of transform functions, for example:

$$z(t + 1) = Az(t) + Bv(t), y(t) = Cz(t), \tag{2-2}$$

This method has two disadvantages: - Functions

$$z(t) = h(x(t)) \text{ and } u(t) = p(x(t), v(t)), \tag{2-3}$$

can be created for few possibilities.

- Constraints, which are usually linear, are transformed to non-linear.

Linearization is used in cases where the model can be linearized by adequate transformation and constraints are considered to be non-linear. Objective function is usually transformed to nonlinear, because it was quadratic in $u(t)$, but not always in $v(t)$. When linear constraints are approximated and objective function was left quadratic the quadratic program for each sample point is the only solution. Linear transform is the only option when both states and input are not deviated from the operation mode. It means that

control actions must be closed into their linearized values to preserve the stability. The system robustness can be sacrificed for computational simplicity [2].

3. Creating the Model Predictive controller

The predictive controller was created in Simulink environment in MATLAB. Models of the Air Pressure system and compressor were obtained through identification of real equipment. The predictive controller uses the quadratic cost function [4]:

$$J(N_1, N_u) = \sum_{i=N_1}^{N_2} \delta(i) [\hat{y}(t + i|t) - w(t + i)]^2 + \sum_{i=1}^{N_u} \lambda(i) [\Delta u(t + i - 1)]^2 \tag{3-1}$$

where $\hat{y}(t + i|t)$ is the predicted output based on the present available information, $w(t + i)$ is the sequence of reference trajectory and $\Delta u(t + i - 1)$ is the computed future actions. The parameter N_1 is the prediction horizon and N_u is the control horizon. The coefficients $\delta(i)$ and $\lambda(i)$ are sequences of weights that consider the future behaviour (usually constant values or exponential sequences).

The prediction horizon was set to 100 and the control horizon to 10. The constraints on manipulated variables were set according to Fig. 2. The control interval was set to 0.3s. These parameters were determined according to experimental tuning of the controller in MATLAB environment. The Model Predictive controller was compared with the PID controller.

Name	Units	Minimum	Maximum	Max Down Rate	Max Up Rate
u1		-0.05	4	-1	1

Fig. 2 Sets of the constraints

The control variables were shifted about 4.5V according to Fig. 3.

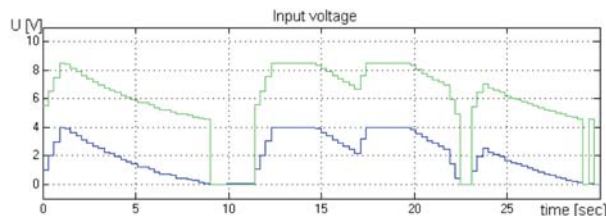

Fig. 3 Shift of control variables

The Fig. 3 shows a block diagram of the predictive closed-loop controller.

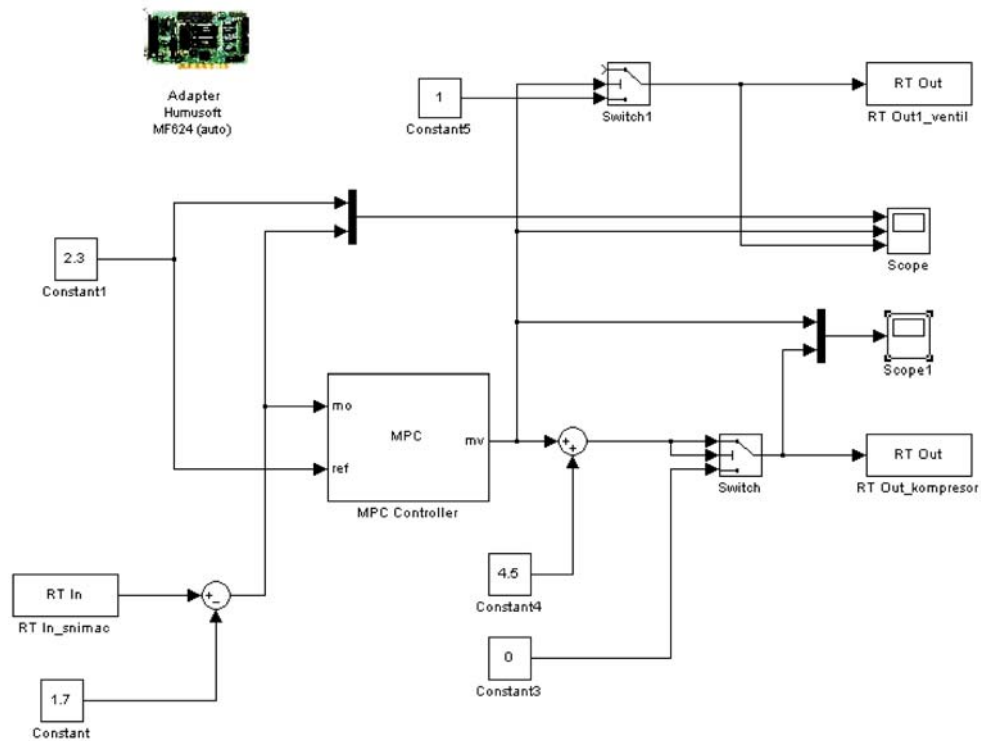

Fig. 4 Closed-loop control of Pressure System using the Predictive Controller

3.1. Simulations in MATLAB environment

The presented simulation results are obtained for the required value of pressure 2.2 kPa (blue/black line). The first graph in Fig. 5 shows the pressure inside the Air Pressure system (green/silver values). In the second graph we can see the control values and the last graph shows that the output valve was not switched on.

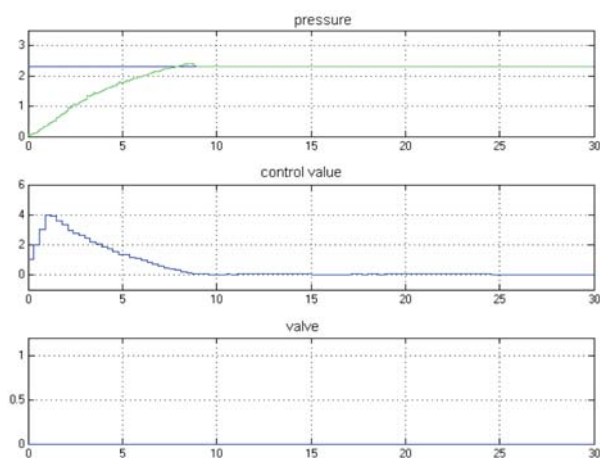

Fig. 5 Simulation results for MPC controller

The second simulation results are obtained for the required value of 2 kPa using the PID controller. The first graph in Fig. 6

shows the pressure inside the Air Pressure system. In the second graph we can see the control values and the last graph shows that the output valve was switched on to decrease air pressure in the system.

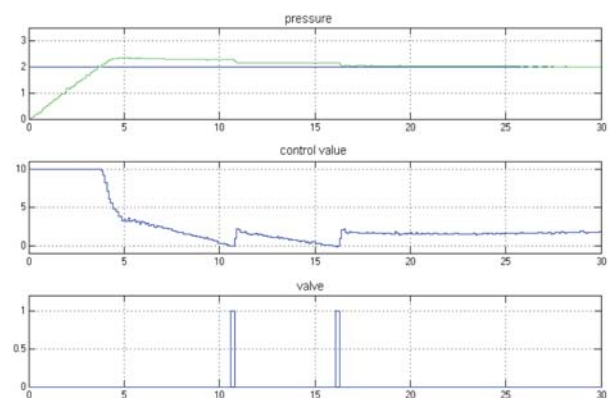

Fig. 6 The results for PID controller

3.2. Stability and non-linear MPC

The efficient solution of the optimal control problem is important for any application of non-linear MPC to real processes, but stability of the closed loop is also of crucial importance. Even in the case that the optimization algorithm finds a solution, this fact

does not guarantee closed-loop stability (even with perfect model match). Several contributions have appeared in recent years, analyzing the regulator problem in a state space framework. The main proposals are the following:

- Infinite horizon. This solution consists of an increase of control and the Prediction horizon to infinity.
- A final limitation. These solutions consist of the final horizon and ensuring stability by adding a state terminal constraint of the form:

$$x(k + P) = x_s. \quad (3-2)$$

- Dual control. This idea defines a region around the final state inside which the system could be driven to the final state by means of a linear state feedback controller. The constraint is:

$$x(t + P) \in \Omega. \quad (3-3)$$

The Nonlinear MPC algorithm is used outside this area. The control program switches to the previous calculated linear strategy once the state exceeds Ω [1].

In our work we used the model linearization. Also, the guarantee of system stability consists of increasing the prediction horizon to a high value.

4. Conclusion

The control quality of predictive controller excessively depends on the tuned values of horizons, constraints and weight matrixes as the practical realization showed. The experimental solutions were presented. We made the comparison between PID and MPC controllers. The controller with fixed structure has less accurate result as the MPC controller. Presented MPC controller can be used as a basis for controlling of various real systems.

Acknowledgement:

This contribution is the result of the project implementation: **Centre of excellence for systems and services of intelligent transport**, ITMS 26220120028 supported by the Research & Development Operational Programme funded by the ERDF.



Agentúra
Ministerstva školstva, vedy, výskumu a športu SR
pre štrukturálne fondy EÚ

"Podporujeme výskumne aktivity na Slovensku/Projekt je spolufinancovaný zo zdrojov EÚ."

References

- [1] CAMACHO, E. F., BORDONS, C.: *Model Predictive Control*. 2nd ed., Springer-Verlag : London Limited, 2004, p. 405, ISBN 1-85233-694-3.
- [2] MACIEJOVSKI, J.M.: *Predictive Control with Constraints*, 2002, p. 331, ISBN 0-201-39823-0.
- [3] JOHANSON, R.: *System Modeling and Identification*, Prentice-Hall, 1993, p. 512, ISBN 0-13-482308-7.
- [4] Help in programme MATLAB7, available on the internet (5.4.2010): <http://www.mathworks.com/products/mpc/>.
- [5] HRBCEK, J.: *Active Control of Rotor Vibration by Model Predictive Control - a simulation study*, In: Report 153, Picaset Oy, Helsinki 2007, ISSN 0356-0872.
- [6] NOSKIEVIC, P.: *System Modeling and Identification*, Ostrava : MONTANEX, a. s., 1999. p. 276, ISBN 80-7225-030-2 (in Czech).
- [7] MACIEJOWSKI, J. M.: *PREDICTIVE CONTROL with Constraints*, Prentice Hall, 2001, p. 102, ISBN 0-201-39823-0.
- [8] BUBNICKI, Z.: *Modern Control Theory*. Springer, 2005, p. 422, ISBN 3-540-23951-0.

Jozef Gnap – Alica Kalasova – Marian Gogola – Jan Ondrus *

THE CENTRE OF EXCELLENCE FOR TRANSPORT SERVICE AND CONTROL

The Centre of Excellence at the University of Zilina was established in 2009 as a new approach to research supported by EU. This model has been acknowledged around the EU as a highly effective way to strengthen a country's research capacity, build partnerships and translate discoveries and advances into economic prosperity and a better quality of life for all citizens. The Centre of Excellence for transport service and control at the Faculty of Operation and Economics of Transport and Communications at the Department of Road and Urban Transport consists of the laboratory of transport service, laboratory of mass passenger transport control and laboratory of freight transport. The main objectives of these laboratories are presented in this article.

Keywords: excellence, laboratory, intelligent transport system, passenger transport, freight transport, transport service.

1. Introduction

A Centre of Excellence is a formalized and documented relationship between Education and Research, the educational institution and the third party. All parties involved in the Centre of Excellence will bring to the partnership a special expertise of strategic importance to transport. A Centre of Excellence can represent either a physical place on the campus of an educational institution. In our case the main topics are defined in the area of intelligent transport systems (ITS) in road and urban transport. In the Centre of Excellence students, transport providers, research workers and scientists will be able to find a selection of ITS-solutions that ease and facilitate our daily lives. Intelligent transportation system has become essential instrument to increase safety and security on the road network, streamline logistics and reduce environmental effects caused by transport. For the educational institution it is very important to create an excellent workplace for R&D systems and intelligent transport services provided as basic infrastructure development companies using technology knowledge.

2. The Centre of Excellence at the Department of Road and Urban Transport

The strategic objective of the Centre of Excellence is in line with the main objective of the call OPVaV-2008/2.1/01-SORO "Operational Research and Development Program – Support networks of excellent research and development departments as pillars of regional development and promotion of regional cooperation". With a focus on technology, industry, or community, the Centre of Excellence will draw upon the expertise of the partners involved to showcase groundbreaking activities and to promote transport

technologies. Intelligent transport is an interdisciplinary problem. Creating the Centre of Excellence is intended to integrate research and teaching staff. The aim is to promote research of high additional value. Some institutes carry out research with end users who will ultimately benefit from its application. This is our interest as well. It can result in the higher level of collaboration between university researchers, graduate students, industry and public sector institutions.

Our research and development program and innovation will help to:

- Clarify innovation plans and medium-term challenges.
- Assemble partners and resources to develop solutions.
- Build collaborative R&D teams to develop technology.
- Access early-stage commercialization support.
- Engage students as future employees to build higher level organization.

The Centre can act as a bridge between transport research, transport companies and regional transport boards to conduct transport studies. It can develop a new model for commercializing university research as well. Put simply, the Centre can help transport companies, councils and their partners to deliver better services by supporting them in their efforts to become more efficient, innovative and engaged with citizens. We develop the team – partners and resources – required to deliver innovative solutions. The Centre is able to offer a wealth of expertise and experience.

The Centre offers:

- Access to research capabilities including facilities, equipment, personnel and experienced research teams.

* Jozef Gnap, Alica Kalasova, Marian Gogola, Jan Ondrus

Faculty of Operation and Economics of Transport and Communications, University of Zilina, Slovakia,
E-mail: jozef.gnap@fpedas.uniza.sk

- Creative students trained in leading-edge knowledge and technology areas.
- Opportunities to participate in a broad range of research initiatives including consortia and collaborative projects.
- Extensive intellectual property and project-management expertise.

3. Laboratory of Transport Service

The strategic objective of the project is to create an excellent laboratory for intelligent transport services as a precondition for infrastructure development companies using technology knowledge.

Movement and its quality is one of the key elements for assessing the standard of living. At the beginning of the 21st. century, our society can not avoid the trends of development in information society, which has a large impact on the transport process. Almost each step of life of our citizens depends on the quality of this service.

It is now necessary to:

- improve road safety and protection of all its users,
- avoid creating congestion,
- reduce the degradation of public transport
- reduce the negative impact on the environment,
- ensure that citizens of the Slovak Republic have access to safe and affordable transport.

The use of new technologies is an essential prerequisite for the introduction of advanced applications to address current traffic problems. Intelligent transport systems are sophisticated multimodal tools that integrate advanced technologies and apply them in transport in order to develop solutions to improve the quality of life for all citizens of Slovakia. The applications help to improve living conditions of the inhabitants, increase time and finance savings in the economic activities of the company, and improve the environment.

The main objectives of transport telematics are to offer to traffic users intelligent services, which must be considered at several levels:

- Services to passengers and drivers (users) - information presented to drivers via information systems on motorways, information sent to drivers to their cars (dynamic navigation), etc.
- Services for infrastructure administrators (administrators of transport roads, administrators terminals) - management of transport infrastructure maintenance, monitoring and management of traffic safety in relation to the economics of traffic routes, etc.
- Services for transport operators (carriers) - selection of traffic routes and most expedient routes, management of vehicle fleet circulation, etc.
- Services for public administration - linking the systems of transport telematics to information systems of public administration, monitoring an assessment of passenger and freight transport, solution of transport infrastructure finance, instruments for execution of transport policy of cities, regions, state.

- Services for security and rescue system - interconnection of the systems of transport telematics with integrated rescue system and security systems of the state, provision of better organization of interventions in liquidation of failures, accidents, enhancement of prevention from occurrence of incidents with ecological consequences.
- Services for financial and control institutions - electronic identification of vehicles and freights, monitoring of and search for stolen vehicles, electronic payments for provided ITS services.

A result of the conceptual interconnection of particular subsystems of transport telematics is the information superstructure over transport, enabling to implement the same management tools for this network sector, like it is today with the management of manufacturing enterprises (monitoring of costs, establishment of separate economic units etc.)

Knowledge of economic processes related to transport will enable execution of the state transport policy and offer a purposeful investment strategy in this branch. This concept of transport telematics can offer clear, controllable and transparent rules for entry of private investors in transport infrastructure (including the own funds of transport telematics).

The basic technologies of transport telematic systems include the following fields, for example:

- Electronic payments - payment for ITS services, for use of infrastructure, means of transport.
- Management of security and rescue measures - management of rescue and security vehicles, monitoring of dangerous freights.
- Management of traffic processes - traffic planning, traffic management, management of transport infrastructure maintenance.
- Management of public passenger transport - integrated transport systems, state administration.
- etc.

Research on intelligent infrastructure systems is linked very closely; every part of it is interactive and conditional. To enable the project to be realized, we need not just the sufficient scientific and research capacities in human resources, but also the instrumentation appropriate to those of current global requirements for research in abovementioned area.

Procured instrumentation will be used to monitor some of the factors that will determine and affect the functioning of intelligent infrastructure systems. By the implementation of this activity, a department of research and development services will achieve the construction place in the area of intelligent infrastructure. The department receives additional opportunities for collaboration or integration into the research grant programs.

4. Laboratory of Mass Passenger Transport Control

The current status of Mass Passenger Transport (MPT) and in general Public Transport (PT) is characterized by decreasing level of ridership. The MPT has to face problems with the moving of

passengers to the individual car transport. A big challenge for MPT consists in the process of implementation of new technologies which can help in the field of operation, management and service. Then the results can be applicable in order to improve the quality of provided service, better operational and management control, etc. The main advantage of the Laboratory of Mass Passenger Transport Control consists in the development of technological environment that can substitute real conditions in order to test, implement and develop various applications and methods for making the service and operation of public transport easier and more qualitative.

The goal is to equip the laboratory with modern technologies allowing the development of rich and useful applications in the field of public transport. At the present time the laboratory has a technology which is focused on passenger and vehicle fare information data and ticket processing.

Therefore, the laboratory will deal with the following research topics:

Fleet management control

This research topic deals with the area of fleet management control where various applications will be tested. This topic includes:

- Effective, consistent real time traffic management service delivery.
- Safe and secure public transport facilities.
- Timely and effective public transport vehicle operations continuity.
- Efficient centre management service delivery.
- Modelling the operation of vehicles.
- Vehicle tracking.
- Vehicle route optimization.
- Analyzing the impact of various traffic conditions, etc.

This topic has a big potential to be an interesting tools for public transport operators. For example, the applications analyze GPS data streams in real time to help fleet managers identify high risk driving behaviour and lower fleet operating costs resulting from excessive speeding. The applications can track and monitor the position and operation of fleet vehicles, giving fleet managers unprecedented visibility into operations delivering cost-saving efficiencies such as real-time GPS tracking of vehicles from the desktop, automatic route optimization, and detailed reporting for advanced decision support and efficient regulatory compliance.

With this application, the dispatchers and managers can view real-time information and summary of data in centre displays to support rapid, optimal decision making for most productive use of vehicles and drivers. These dashboards can drill down and include information customized to the needs of individual users.

Passenger's information system

The information in public transport is an essential for passenger. The common standard of static bus top information doesn't meet the requirements for actual and real time information in the technological highly depended society. One goal of our laboratory will be to test the new form of the information providing regard-

ing to the public transport service. Not only in direction from PT operators to passengers, but also from passengers to operators.

Passenger service

This topic includes analyzing and testing various technologies which are suitable for passenger processing as types of tickets, types of passengers. The passengers use the modern technologies that allow the information sharing about them and that is the reason for implementing such technologies into the passenger service.

The laboratory will also serve as virtual PT operation centre where following research topics will be included:

- Data processing.
- Passenger information systems in stops, vehicles.
- Booking systems for mass passenger transport, taxi.
- Passenger time schedule information PDZ, RDS-TMC.
- Solving static transport, parking.
- Providing information via internet, mobile phones and etc.
- Demand responsive service.
- New types of passenger processing.
- The results can be applied in ecological issues, sustainable mobility.
- Forecasting future travel demand.
- Tariff testing.
- Virtual public transport network.
- Applying geographic information systems.

5. Laboratory of Freight Transport

This laboratory will cover the three main areas of freight transport:

Load securing

This research activity will contribute to the transport safety within load securing during the carriage. The aim is to provide load securing instructions and certificates about safe load securing with big influence on traffic safety within the national and European level. Many manufacturers export their goods from Slovakia abroad. There is no such a laboratory in Slovakia but there are manufacturers of load securing equipment both in Slovakia and in Zilina. The testing of vehicle superstructures for load securing is also missing and majority of superstructures produced in Slovakia does not have any load security testing.

Following research areas will be covered by these facilities:

- testing of package stability for surface transport (road, rail, water) – Fig.1,
- strength testing of lashing bands, straps, chains, steel ropes (EN 12195-2, 3, 4) – Fig.2,
- static and dynamic load securing tests and identification of wrong load securing (traffic safety),
- static and dynamic tests for friction coefficients in laboratory conditions and in practice – Fig.3,
- monitoring of inertia forces inside cargo transport units (vehicle, wagon, container) during real carriages,

- analysis of load damages rising from insufficient packaging and load securing.

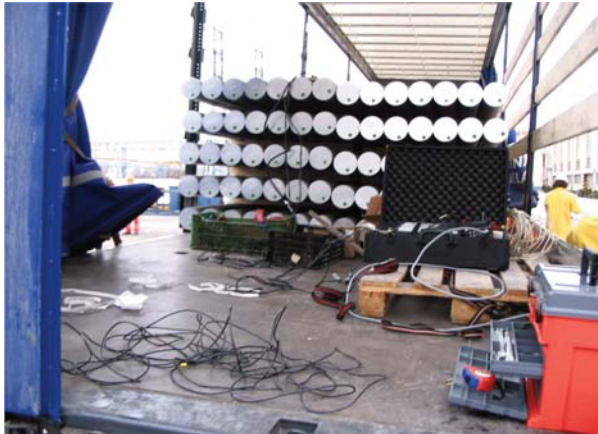

Fig. 1 Dynamic test of package stability



Fig. 2 Strength test of lashing bands



Fig. 3 Test for friction coefficients in laboratory in Germany

Quality and safety of transport service

Measurements, monitoring and evaluation of basic transport parameters during the carriage and storage in warehouses and

logistic centres is covered by these activities in accordance with ATP agreement, laws and regulations and customer requirements. Following equipment will perform these activities:

- 3-axes acceleration sensor,
- 1-axis acceleration sensor,
- temperature sensor,
- pressure sensor,
- humidity sensor,
- tilt and roll sensor,
- position sensor (GPS),
- remote on-line communication with monitoring device.

Testing of control recording equipment (tachographs) and information technology in transport

The laboratory will test recording equipment and assess their compliance with legislation. The laboratory will further evaluate the possibility of using tachographs recorded data for management and monitoring of road transport and improve safety and transport services. In practice, we encounter the fact that not all possibilities of digital tachographs are actually used for fleet management. However, digital tachographs recorded in real time large amounts of information [20].

The aim of the laboratory would also be evaluation of information technology used in road transport. On the market there are a number of information technology and software which do not provide appropriate information for management of road transport. The laboratory will process the requests for upgrading the analyzed technology to the most streamline operation in transport services.



Fig. 4 Workplace for testing digital tachographs (example from DEKRA company)

6. Conclusion

It must be appreciated that the EU Structural Funds will be available for building excellent laboratories. The laboratories will be very useful not only for research and development activities but also for raising the level of knowledge and practice of students of all university degrees in transport control and transport services.

Acknowledgement:

This contribution is the result of the project implementation:
Centre of excellence for systems and services of intelligent trans-

port, ITMS 26220120028 supported by the Research & Development Operational Programme funded by the ERDF.



"Podporujeme vyskumne aktivity na Slovensku/Projekt je spolufinancovany zo zdrojov EU."

References

- [1] BANISTER, D.: *Transport Planning*, University College London, 2002, 2nd edition, 2007. ISBN 0415261724.
- [2] COLEMAN, A.F.: *Transport Planning and Traffic Engineering*. Ed. Heinemann, 1996, ISBN 978-0-340-66279-3.
- [3] KRIVDA, V., OLIVKOVA, I., PALO, J., RICHTAR, M.: *Transport Telematics*. Published by EDIS ZU in Zilina, 2009, ISBN 978-80-8070-981-5.
- [4] SCHLOSSER, T.: *Intelligent Transport Systems*, 2001, ISBN 80-88905-64-8.
- [5] SVITEK, M.: Telematic Services Connected with the Electronic Toll System. *Technologies & Prosperity*, Praha 2006, ISSN 1213-7162.
- [6] JAGELCAK, J., GNAJ, J.: *The Instructions for Securing of Goods in Freight Road Transport*. PROFITUBE s.r.o. Kosice, University of Zilina, Zilina, 2007.
- [7] JAGELCAK, J., GNAJ, J.: *The Instructions for Securing of Goods in Freight Road Transport SLOVALCO a.s.*, ZU v Ziline, Zilina, 2007.
- [8] JAGELCAK, J., GNAJ, J.: *The Instructions for Securing of Goods in Freight Road Transport*. DUSLO a.s., ZU v Ziline, ZU, 2007.
- [9] IMO/ILO/UN ECE *Guidelines for Packing of Cargo Transport Units (CTUs)*, International Maritime Organization, London, 1997, ISBN 92-801-1443-3.
- [10] *Safe Packing of Cargo Transport Units (CTUs) - COURSE*, Model course 3.18, International Maritime Organization, London, 2001, ISBN 92-801-5116-9.
- [11] *Safe Packing of Cargo Transport Units (CTUs) - WORKING BOOK* with quick lashing guides for transport on road and in sea areas A, B, & C, Model course 3.18, International Maritime Organization, London, 2001, ISBN 92-801-5127-4.
- [12] JAGELCAK, J.: *Verification Measurements of Frequent Lashing Methods and Load Distribution Diagram* [on-line] - Version 2.2. - Zilina, (C) Juraj Jagelcak, 2006, p. 59 <<http://kcmd.uniza.sk/securing/securingSKEN.pdf>>.
- [13] ANDERSSON, P., JAGELCAK, J., LIND, E., PETERSEN, S.S.: *Report from Pulling Tests with Used Lashing Equipment* [on-line], [Hoganas: MariTerm AB], 2009. <<http://www.mariterm.se/hoganas/rapporter.html>>.
- [14] JAGELCAK, J., RIEVAJ, V.: *Standard Tension Force: Tension Forces in Web-lashing for Load Securing Created by a Ratchet Tensioner* [1st ed.]. Koln: Lambert Academic Publishing AG & Co. KG, 2009. ISBN 978-3-8383-1817-2.
- [15] JAGELCAK, J.: *Tension Forces in Web-lashing for Load Securing*. In: CDMTUR 2009 [electronic source]; Proc. of 5th int. conference : Zilina, Slovakia, 2009, Zilinska univerzita, EDIS ZU, 2009. ISBN 978-80-554-0124-9, pp. 70-74, CD-ROM.
- [16] EN 12195-2 *Load Restraint Assemblies on Road Vehicles. Safety. Part 2: Web Lashing Made from Man-made Fibres*.
- [17] EN 12195-3 *Load Restraint Assemblies on Road Vehicles. Safety. Part 3: Lashing Chains*.
- [18] EN 12195-4 *Load Restraint Assemblies on Road Vehicles. Safety. Part 4: Lashing Steel Wire RSopes*.
- [19] *European Best Practice Guidelines on Cargo Securing for Road Transport* [on-line], [Andersson, P. ... et al.]. Online document. [Brussels: European Commission, Directorate-General for Energy and Transport], 2006. p. 208, <http://ec.europa.eu/transport/road_safety/vehicles/doc/cargo_securing_guidelines_en.pdf> [Coauthors: Arbaiza, Alberto; Bonnet, Geraldine; Charalampopoulos, George; Finn Engelbrecht, Ruby; Hassing, Sibrand; Jagelcak, Juraj; Jonckheere, Filip; Kolettas, Soteris; Kuusk, Harri; Karki, Esko; Linssen, Hubert; Lundqvist, Anders; Manolotou, Eleni; Martins, Joao; Nordstrom, Rolf; Pompe, Julie; Prochazka, Milos; Renier, Luc; Rocco, Luca; Rolland, Nathalie; Ruzgus, Gintautas; Schoofs, Cyriel; Siegmann, Ernst Otto; Surmont, Charles; Vaikmaa, Siim; Vaituzs, Zulizs; Van Praet, Willy; Verlinden, Jos; Wiltzius, Marc; Winkelbauer, Martin]
- [20] POLIAK, M., GNAJ, J.: *The Wwork of Drivers of Freight Vehicles and Buses and Usage of the Tachographs - extended and updated version to 1st. 2. 2009*; Zilinska univerzita: EDIS - ZU, Zilina, 2009; ISBN 978-80-7100-989-1.

Jana Dicova – Jan Ondrus *

TREND OF PUBLIC MASS TRANSPORT INDICATORS – AS A TOOL OF TRANSPORT MANAGEMENT AND DEVELOPMENT OF REGIONS

Quantification of customer requirements is necessary for all managers that continually monitor changing transport market environment and the quantification also introduces a fundamental tool that allows evaluations of current situation. On the basic assess of reached results in last periods of time the quantification also contributes to create a quality proposal of future lead to entrepreneurship in transport. The article deals with problems of possible application of appropriate methods of application that allow to reach the best quantification of next customer requirements in transport, also contribute to realization of strategic objectives and development and improve decision making concerning next trends in region.

Keywords: regional management, mass public transport (MPT), prediction, methods, public mass transport indicators

1. Introduction

Regional development is more dependent on and influenced by articles and activities of managers in several regions for their ability to learn and innovate in conditions of permanently realized dynamical changes in regional macroenvironment and also in micro-environment. With respect to these facts, greater resolution sets to action and projects the character of future trend monitoring indicators of development regional planning that will note the influence of changed external environment, new globalization tendencies, integration and increased pressure of competition.

The aim of regional management to create operational conditions and development of territorial independently operating system – region, impacted and developed in competitive environment, advocacy of development concepts, generation of new project ideas and also contribution to creation of conditions for successful position of responsible region.

Also passenger transport influences the positive development. It contributes to accommodate the everyday requirements of customers to transport and contributes to physical achievement of basic transport objective: free movement of people.

2. Importance of regional management

Spatial distribution of the Slovak territory was changed successively from time perspective, by management, level of understanding, tool facility and also by influence of changed external

conditions. Nowadays we can assess the trend of various parts of territory in particular by dividing to regions – Bratislava, West Slovakia, Central Slovakia and East Slovakia, but every region has reached different results with respect to particularities of several regions.

Regional management can be defined as a regional planning tool, global attitude to existing and new planned tasks, new philosophy of planning, new conception of leadership and realization of intentions.

Regional management is able to:

- mobilize internal and external potential,
- provide current information for regional development and focus on trend to future, possibilities of new technologies and innovative applications,
- use of applications of specific plans, provisions and projects by professional project management,
- sales and coordination of available regional resources from personnel skills and organizational point of view.

Regional marketing presents the key aspect of specific techniques and procedures allowing a management application in real conditions of the region. Regional marketing also includes the procedures oriented to creation, preservation or change of attitudes or behaviour to the region. The regional marketing offers methods and tools to ensure the development given by the region and acquirement of its prosperity. It defines products and development perspectives and introduces the conformity of region supply together with market requirements and evaluation and optimal using of its

* Jana Dicova¹, Jan Ondrus²

¹ Faculty of Management Science and Informatics, University of Zilina, Slovakia, E-mail: Jana.Dicova@fri.uniza.sk

² Faculty of Operation and Economics of Transport and Communications, University of Zilina, Slovakia

resources and complete potential. The regional marketing leads to satisfaction of regional requirements together with public interests.

3. Mass Public Transport in Regions and Possibilities of Prediction

Mass public passenger transport presents an important social and economic component of environment in its impact. It has the character of a population service focusing on tasks consisting of accommodating its everyday requirements for transport (travel to work, schools, offices, health centres, etc.). This task is – in conditions of the SR – dominant in participation of passenger bus and railway transport and has unforgettable (non-representational) position in suburban and railway transport and urban passenger transport within transport services of urban agglomerations and cities. [6]

Mass public transport is an important functional component of a town and region and we can divide it to [5]:

- a) mass public transport that ensures the transport serviceability of a region:
 - regular (periodic) bus transport :
 - long-distance bus transport,
 - suburban bus transport,
 - railway public transport:
 - realized on state-owned railways,
 - realized on regional railways.
- b) mass public transport that ensures transport serviceability of a town:
 - urban bus transport,
 - trolley transport,
 - tram transport,
 - subway.

Transport requirements of population present a significant factor of life style and the function of public transport is providing such transport connection so that it arises the requirement to be satisfied in the utmost degree. And at the same time the transportation should be carried out the most efficiently due to the nature of the region. [3]

Quantification of customers' requirements in transport process can by transport indicators (number of passengers and transport performance). The trend can be to define as progression of indicators that are changed with respect to time function, dependence on parameters and represents trend tendencies of movement.

The Slovak Republic can be divided to following regions:

- = West Slovakia (Trnava, Trencin, Nitra districts),
- = Central Slovakia (Banska Bystrica, Zilina districts),
- = East Slovakia (Kosice, Presov districts),
- = Bratislava district.

Trend of number of passengers in several regions of the Slovak Republic is a process for period 2001 – 2008, sees Table 1. From long-term perspective trend in number of passengers we can observe that in each region there is a decrease every year. The greatest decrease of number of passengers was in Central Slovakia. There was a decrease in number of passengers in one year from 193,117 million of passengers to 112,720 million of passengers, which represents substantial decrease by 41.6 % between years the 2001 and 2008. Conversely, the lowest decrease in the number of passengers was in Bratislava region, concretely 25.5 % from 22,743 million of passengers in the year 2001 to 16,934 million of passengers in year 2008. The average decrease of number of passengers in all the regions during the period 2001-2008 is by 35.5 %: from 566,445

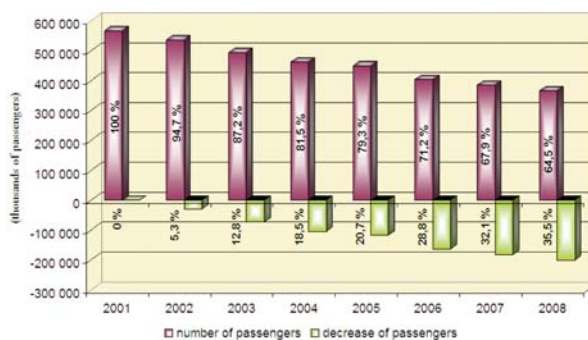

Fig. 1 Trend in Number of Passengers in Enterprises which are Specialized in Road Transport in Regions of Slovak Republic

Number of Passengers in the Enterprises which are Specialized in Road Transport (thousands of passengers)

Table 1

Region	Number of passengers (thousands of passengers)							
	2001	2002	2003	2004	2005	2006	2007	2008
Bratislava district	22 743	22 549	20 220	19 014	18 229	17 658	17 094	16 934
West Slovakia	228 726	210 574	187 298	177 984	184 004	160 058	155 547	152 328
Central Slovakia	193 117	184 941	174 878	161 323	149 186	130 528	122 413	112 720
East Slovakia	121 859	118 549	111 310	103 451	98 037	95 026	89 583	83 537
Total	566 445	536 613	493 706	461 772	449 456	403 270	384 637	365 519

Source: The Statistical Office of the SR

million of passengers in 2001 to 365,519 million of passengers in 2008 (Fig. 1).

To ensure the transport serviceability in regions, systems participate with different capacity of the means of transport and with different change of passengers. It is necessary to monitor also the realized transport performance in millions of passengers per kilometre except the number of passengers. There is a comparison of transport performance and its trend during several years of monitoring time in the table 2. The greatest decrease of transport performance was in Central Slovakia. Decrease of transport performance per year from 2 362 millions of passengerkilometres to 1 701 millions of passengerkilometres presents substantial decrease by 28 % between years the 2001 and 2008. The lowest decrease of transport performance was in East Slovakia: only 16.2 %, from 2 288 million of passengerkilometres to 1 917 million of passengerkilometres.

Figure 2 shows the processed trend of transport performance in several regions of Slovak Republic in monitored time during the years 2001 - 2008. While number of passenger in enterprises specialized in road transport in several regions of Slovak republic decreases, the transport performance in monitored time has also moderately increasing tendency (for example years 2002, 2004, 2006). In 2008, the transport performance in several regions of Slovak Republic was at a level of 78.1 % of transport performance realized in 2001.

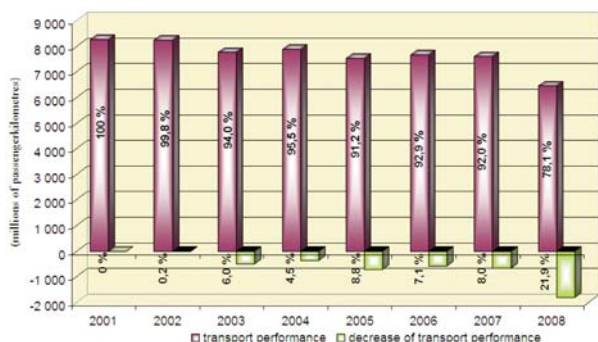

Fig. 2 Trend of Transport Performance in Enterprise Specialized in Road Transport in Regions of Slovak Republic

Succession of steps that allow determining the forecast of transport indicators trend to future is represented at Fig. 3. Input information for choosing the appropriate model of trend and prediction introduces quantified customer requirements of transport process (indicators of performances MPT) take into consideration spatial distribution of Slovakian territory and time aspect (time period: years 2001–2008).

The corect identification of input information creates the basis for modelling, which is a tool of systemic analysis of complicated problem solving where it can include also the determination of development of investigating indicators prediction. Model choice is influenced by time series analysis of input information on basis of decomposition. The main reason of decomposition is a revelation of relations and trend tendencies; depurated from seasonality, the forecast is better purposed. The main condition is to represent every single value of time series that can be represented as a summation or product of its components by single models of time variable.

View of Selected Prognostic Methods Table 3

Methods	Form	Characteristic
Exponential smoothing (Brown's model)	$T_{t-k} = A_{0t} - A_{1t} \cdot k$	= based on increase of observed value towards initial situation (condition), represents trend relation, typical is increase growth rate of models parameters,
Holt's exponential smoothing	$T_t = A_{0t} + A_{1t} \cdot t$	= using exponential smoothing, appropriate to application if time series have evidently linear trend and exponential smoothing takes distorted value,
Quadratic trends	$T_t = A_0 + A_1 \cdot t + A_2 \cdot t^2$	= not suitable method to application of prognosis with remote time, application in case if trend has parabola shape.

Application of selected methods represents a choice of appropriate trend function for given time series on the basis of realized

Number of Transport Performance in the Enterprises Specialized in Road Transport (Millions of Passengerkilometres) Table 2

Region	Transport performance (millions of passengerkilometres)							
	2001	2002	2003	2004	2005	2006	2007	2008
Bratislava district	566	820	483	511	469	479	478	449
West Slovakia	3 037	3 101	2 888	2 938	2 886	3 009	3 076	2 379
Central Slovakia	2 362	2 125	2 178	2 022	2 065	2 050	2 145	1 701
East Slovakia	2 288	2 190	2 208	2 411	2 105	2 127	1 897	1 917
Total	8 253	8 236	7 757	7 882	7 525	7 665	7 596	6 446

Source: The Statistical Office of SR

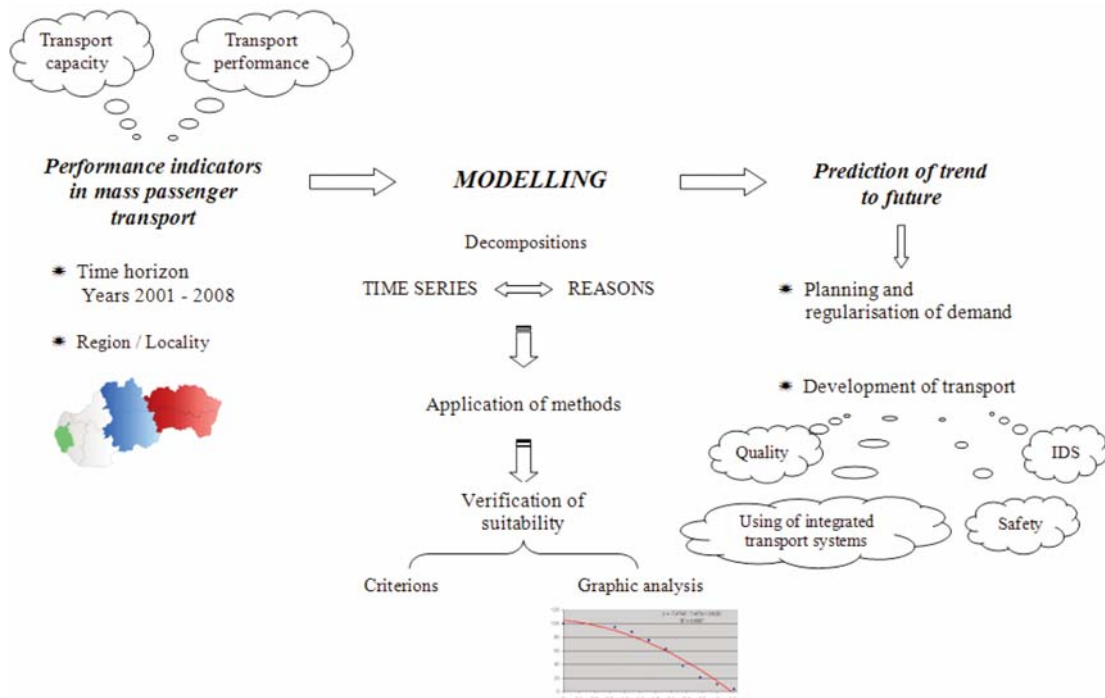

Fig. 3 Succession of Steps for Determination of Trend Performance MPT

decomposition and estimated attributes of development with respect to examined problems. From value time trend will be estimated model parameters. In case that we initiate presumption parameters, the complete condition of importance can be used to determination of forecast.

$$RMSE = \frac{1}{N} \sum_{i=1}^N (y_i - \hat{y}_i)^2 \tag{1}$$

Consecutively after evaluation of reached results quantities, value of future trend investigating indicators follows the period of the year 2009.

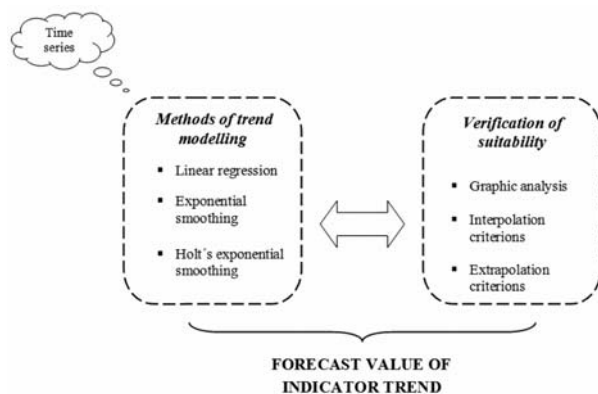

Fig. 4 Succession of Steps for the Forecast of the Indicator Trend

Verification of appropriateness of applied methods is realized on basis of adjudication of selected criteria because of the reason of measure precision; smoothing finding or average value residues characteristics (variance of real trend value y_t and smoothing ~ estimated trend value \hat{y}_t) introduces value RMSE.

Indicators of MPT of Bratislava Region at the Period of Years 2001-2009 Table 4

Year	Value of MPT indicator		Predictions of MPT indicator	
	Number of passengers (thousands of passengers)	Transport performance (millions of passengerkilometres)	Number of passengers - by methods exponential smoothing	Transport performance - by methods Holt's exponential smoothing
2001	22 743	566	22 571.1	-
2002	22 549	820	21 547.7	-
2003	20 220	483	20 570.6	508.87
2004	19 014	511	19 637.8	491.09
2005	18 229	469	18 747.4	494.41
2006	17 658	479	17 897.3	475.61
2007	17 094	478	17 085.8	468.11
2008	16 934	449	16 311.0	465.13
2009	-	-	15 571.4	449.12

* Note. Prediction was evaluated from time series from years 2003 - 2008

In monitored period of time 2001–2008, there was by indicator transport performance one extreme value by indicator of transport performance (in 2002 there was an increase of 44.86 %, but in next years this difference wasn't repeated any more). This value was a negatively influenced and misrepresented quantification of followed indicators forecast of MPT – transport performance, with respect to application smoothing method. So it was necessary to regulate the following time series and time series were applied for the forecast of years 2003–2008. To initiate the regulated time period, the service methods were used on basis of graphic analysis adjudication *Holt's exponential smoothing and methods of linear trend and methods exponential smoothing*. After the application of time series, the verification of appropriateness single methods by selected criterions followed. As the most appropriate methods that describe in the best way the trend of time series methods, *Holt's e exponential smoothing* has been evaluated because by determined criterions, it has reached the lowest value of RMSE (value was 22,8061) and all model parameters were important. Other applied methods had no important model parameters and so can't recommend the application these methods (*methods of linear trend and exponential smoothing*). Number of passengers by using method exponential smoothing reached the best results and the forecast values for the year 2009 were quantities of 15 571,4 thousand of passengers.

Indicators of MPT of West Slovakia Region at the Period of Years 2001–2009 Table 5

Year	Value of MPT indicator		Predictions of MPT indicator	
	Number of passengers (thousands of passengers)	Transport performance (millions of passengerkilometres)	Number of passengers – by methods exponential smoothing	Transport performance – by methods exponential smoothing
2001	228 726	3 037	220 291	2 910.31
2002	210 574	3 101	208 061	2 940.86
2003	187 298	2 888	196 509	2 979.49
2004	177 984	2 938	185 599	2 957.42
2005	184 004	2 886	175 295	2 952.74
2006	160 058	3 009	165 563	2 936.64
2007	155 547	3 076	156 371	2 954.09
2008	152 328	2 379	147 689	2 983.50
2009	-	-	139 489	2 837.69

Values of transport performance time series reached relatively periodic trend in monitored period of years 2001–2008, the only exception created the year 2008, when there was a rapid decrease by 20,70 % to value 1 701 millions of passengerkilometres. For this trend, selected methods were applied – methods of *exponential smoothing, Holt's e exponential smoothing and Brown's linear exponential smoothing*. On the basis of criterion of the lowest value acquirement, RMSE can be considered as the most appropriate in the method of *exponential smoothing* (value RMSE is 250.83). But it is necessary to point out that prediction value to year 2009 will also be influenced by the rapid change of value transport per-

formance which started the year before (in 2008) and its next trend. The best way how the recommended application was considered was by application recommended method. For the trend of indicator number of passengers, the best method described was *exponential smoothing, Holt's e exponential smoothing*, but the better measure of smoothing precision (RMSE = 7 622.89) was reached by application method *exponential smoothing*.

Indicators of MPT of Central Slovakia Region at the Period of Years 2001–2009 Table 6

Year	Value of MPT indicator		Predictions of MPT indicator	
	Number of passengers (thousands of passengers)	Transport performance (millions of passengerkilometres)	Number of passengers – by methods Holt's exponential smoothing	Transport performance – by methods Holt's exponential smoothing
2001	193 117	2 362	194 569	2 366.55
2002	184 941	2 125	181 833	2 323.30
2003	174 878	2 178	170 893	2 164.41
2004	161 323	2 022	160 675	2 100.44
2005	149 186	2 065	149 465	1 983.98
2006	130 528	2 050	137 929	1 949.94
2007	122 413	2 145	123 305	1 939.78
2008	112 720	1 701	110 655	2 007.53
2009	-	-	99 175.7	1 803.55

Trend of transport performance can describe in the best way by methods of *exponential smoothing and Holt's exponential smoothing* with respect to progress of time series of input information from monitoring time. Considering the suitability model criterion determined as the most appropriate methods *Holt's exponential smoothing* and the followed indicator has decreased, value 99 175.7 thousand of passengers by RMSE = 3 829.37. On the basis of initial adjudication of graphic representation of time series trend of transport performance, these trend selected follow methods were determined – *exponential smoothing and Holt's exponential smoothing*. Both these methods can be applied with respect to importance of model parameter, but by taking into consideration of criterion RMSE. The best method is *Holt's exponential smoothing* (RMSE has value 181.82 and method exponential smoothing has reached the value RMSE = 189.31).

Parabolic trend of number of passengers had pointed out appropriateness using of method *quadratic trends* but in following period, there is a forecast of decrease of indicators to value 79 369.5 thousands of passengers. Time series of transport performance value in monitored time was evaluated with respect to trends by methods *exponential smoothing, Holt's exponential smoothing and Brown's linear exponential smoothing*. Method of *exponential smoothing* after application forecasted too high value of smoothing constant and for that reason its application wasn't good. Method Brown's linear exponential smoothing has reached convenient results but RMSE has higher value (162.61) in comparison with method Holt's exponential smoothing that achieved value RMSE = 150.04 after appli-

Indicators of MPT of East Slovakia Region at the Period of Years 2001-2009 Table 7

Year	Value of MPT indicator		Predictions of MPT indicator	
	Number of passengers (thousands of passengers)	Transport performance (millions of passengerkilometres)	Number of passengers - by methods exponential smoothing	Transport performance - by methods Holt's exponential smoothing
2001	121 859	2 288	122 953	2 272.36
2002	118 549	2 190	116 694	2 227.03
2003	111 310	2 208	110 667	2 164.24
2004	103 451	2 411	104 872	2 127.14
2005	98 037	2 105	99 308,1	2 179.29
2006	95 026	2 127	93 976.0	2 127.61
2007	89 583	1 897	88 875,6	2 095.96
2008	83 537	1 917	84 006,8	1 993.55
2009	-	-	79 369.5	1 918.08

ation, with respect to these criterions of model appropriateness, the use of mentioned method is recommended: *Holt's exponential smoothing*.

4. Conclusion

Accomplishment of fundamental functions and operations of populated regions and cities depends on mass passenger transport that must ensure all necessary transport requirements. To forefront extends distinctively strongly urgency of good coordination of all operations in complete transport systems and in conditions of

increasing transport requirements and demands there is a need of development of regions and cities. [4]

The self-contained participants are essential in the process coordination (municipalities, cities, interest groups, natural person, juristic person, etc.) and put the emphasis on creativity, communication ability, ideas richness, engagement, effort to solve problems, flexibility, persuasion and natural authority. [1]

In regional management it is necessary to create a modern and elementary procedure and structure of managerial work. Just implementation of appropriate prognostic methods and planning models those allows to determine the planned value of supply and demand by evaluation of time series trend introducing the possible solution to reach stable and long time results of region and transport enterprise activities and also the application of intelligent transport systems, integrating transport systems, safety and quality of services.

Regional management of the area can allow to Slovak regions and municipalities fast adaptation to conditions of EU market as innovation and integrated management tools. Regional management can help to break through and assume to market with competitive supply gives to Slovaks new human and financial capital and so ensures a long-term perspective and permanent sustainable development. [1]

Acknowledgement

This contribution is the result of the project implementation: **Centre of excellence for systems and services of intelligent transport**, ITMS 26220120028 supported by the Research & Development Operational Programme funded by the ERDF.



"Podporujeme vyskumne aktivity na Slovensku/Projekt je spolufinancovany zo zdrojov EU."

References

- [1] DICOVA, J.: *Importance of Regional Planning and Regional Management for Regions Development (in Slovak)*. In: Ref. of Intern. seminar Regionalni management a E-learning, Pardubice: Fakulta ekonomicko-spravni : Univerzita Pardubice, 2006, pp. 19-23, ISBN 80-7194-917-5.
- [2] CHAJDIK, J., RUBLIKOVÁ, E., GUDABA, M.: *Statistic Methods in Practice (in Slovak)*, STATIS Bratislava, 1994.
- [3] POLIAK, M., KONECNY, V.: *Market of Mass Public Transport and its Financing (in Slovak)*, Zilinska univerzita, 2009, ISBN 978-80-8070-999-0
- [4] SUROVEC, P.: *Mass Public Transport (in Slovak)*, Zilinska univerzita, 2007, ISBN 978-80-8070-686-9.
- [5] SUROVEC, P.: *Technology of Mass Public Transport (in Slovak)*, Zilinska univerzita, 1998, ISBN 80-7100-494-4.
- [6] Government Resolution of SR Nr. 377/2005 *Conception of public buss and railway transport with emphasis on systemic solution of financing performances in public interests in 2005 and following years*.
- [7] The Statistical Office of the Slovak Republic - www.statistics.sk.

COMMUNICATIONS - Scientific Letters of the University of Zilina Writer's Guidelines

1. Submissions for publication must be unpublished and not be a multiple submission.
2. Manuscripts written in **English language** must include **abstract** also written in English. The submission should not exceed **10 pages** with figures and tables (format A4, Times Roman size 12). The **abstract** should not exceed 10 lines.
3. Submissions should be sent: **by e-mail** (as attachment in application MS WORD) to one of the following addresses: *komunikacie@uniza.sk* or *holesa@uniza.sk* or *vrablova@uniza.sk* or *polednak@fsi.uniza.sk* **with a hard copy** (to be assessed by the editorial board) **or on a CD** with a hard copy to the following address: Zilinska univerzita, OVaV, Univerzitná 1, SK-010 26 Zilina, Slovakia.
4. Abbreviations, which are not common, must be used in full when mentioned for the first time.
5. Figures, graphs and diagrams, if not processed by Microsoft WORD, must be sent in electronic form (as GIF, JPG, TIFF, BMP files) or drawn in contrast on white paper, one copy enclosed. Photographs for publication must be either contrastive or on a slide.
6. References are to be marked either in the text or as footnotes numbered respectively. Numbers must be in square brackets. The list of references should follow the paper (according to **ISO 690**).
7. The author's exact **mailing address of the organisation where the author works, full names, e-mail address or fax or telephone number**, must be enclosed.
8. The editorial board will assess the submission in its following session. In the case that the article is accepted for future volumes, the board submits the manuscript to the editors for review and language correction. After reviewing and incorporating the editor's remarks, the final draft (before printing) will be sent to authors for final review and adjustment.
9. The deadlines for submissions are as follows: September 30, December 31, March 31 and June 30.

COMMUNICATIONS

SCIENTIFIC LETTERS OF THE UNIVERSITY OF ZILINA
VOLUME 12

Editor-in-chief:

Prof. Ing. Pavel Polednak, PhD.

Editorial board:

Prof. Ing. Jan Bujnak, CSc. - SK
 Prof. Ing. Otakar Bokuvka, CSc. - SK
 Prof. RNDr. Peter Bury, CSc. - SK
 Prof. RNDr. Jan Cerny, DrSc. - CZ
 Prof. Eduard I. Danilenko, DrSc. - UKR
 Prof. Ing. Branislav Dobrucky, CSc. - SK
 Dr.hab Inž. Stefania Grzeszczyk, prof. PO - PL
 Prof. Ing. Vladimír Hlavna, PhD. - SK
 Prof. RNDr. Jaroslav Janacek, CSc. - SK
 Prof. Ing. Hermann Knoflachner - A
 Doc. Dr. Zdena Kralova, PhD. - SK
 Prof. Ing. Milan Moravcik, CSc. - SK
 Prof. Ing. Gianni Nicoletto - I
 Prof. Ing. Ludovít Parilak, CSc. - SK
 Ing. Miroslav Pfliegel, CSc. - SK
 Prof. Ing. Pavel Polednak, PhD. - SK
 Prof. Bruno Salgues - F
 Prof. Andreas Steimel - D
 Prof. Ing. Miroslav Steiner, DrSc. - CZ
 Prof. Ing. Pavel Surovec, CSc. - SK
 Prof. Josu Takala - SU
 Doc. Ing. Martin Vaculik, CSc. - SK

Address of the editorial office:

Zilinská univerzita
 Office for Science and Research
 (OVaV)
 Univerzitná 1
 SK 010 26 Zilina
 Slovakia
 E-mail: komunikacie@nic.uniza.sk,
 pavel.polednak@fsi.uniza.sk

Each paper was reviewed by two reviewers.

Journal is excerpted in Compendex and Scopus

It is published by the University of Zilina in
 EDIS - Publishing Institution of Zilina University
 Registered No: EV 3672/09
 ISSN 1335-4205

Published quarterly

Single issues of the journal can be found on:
<http://www.uniza.sk/komunikacie>