

INTERNATIONAL CONFERENCE ON 21ST CENTURY EDUCATION 2015

November 13 - 15, 2015

Higher Colleges of Technology - Dubai Men's College
Academic City, Dubai, UAE

Applied Learning: Preparing 21st Century Citizens for Work and Life

Organized by the 21st Century Academic Forum and the Higher Colleges of Technology



Applied Learning: Preparing 21st Century Citizens for Work and Life
21st Century Academic Forum
IC21CE 2015 / ICLLT 2015 Conference Proceedings

Editor

MARIA HABBOUSHI: Saint Louis University, 1 North Grand Boulevard
Saint Louis, MO 63103 U.S.A.
Tel: (+1) 314-828-0040; Email: mhabbous@slu.edu

Conference Proceedings Editorial Board Members

OMAR ADRA, University of Balamand, Lebanon
FARAH ARAB, University of Montreal, Université Paris 8
ELIZABETH FINOCCHIARO, Saint Louis University, MO, USA
HENK HUIJSER, Xi'an Jiaotong-Liverpool University, China
WHITNEY LINSENMEYER, Saint Louis University, MO, USA
ALEX MONCEAUX, Lamar University, TX, USA
ROEHL SYBING, Nanzan University
GENNY VILLA, Université Montreal, Quebec, Canada

Impressum:

The papers included in this volume were part of parallel international conferences, the International Conference on 21st Century Education 2015 and International Conference on Language Learning and Teaching 2015: Applied Learning: Preparing 21st Century Citizens for Work and Life. Papers were selected and subject to review by the editors and conference program committee. The papers published in these proceedings reflect the work and thoughts of the authors and are published herein as submitted.

Please use the following format to cite material from this book: Author(s), (2016) "Title of the Paper" in Applied Learning: Preparing 21st Century Citizens for Work and Life, Vol. 7, No. 1, edited by Maria Habboushi, 21st Century Academic Forum Harvard Conference Proceedings, Bozeman, Montana (ISSN: 2330-1236) Copyright © 2016, 21st Century Academic Forum

Publisher: *Facilitating, Fostering and Harnessing Innovation to Meet Key Challenges of the 21st Century* is published by 21st Century Academic Forum, 141 Discovery Drive, Suite 107, Bozeman, MT, 59718, USA. Email contact address is: publications@21caf.org.

Production Editor: Maria Habboushi (mhabbous@slu.edu)

Copyright and photocopying: ©21CAF Publishing. All rights reserved. No part of this publication may be reproduced, stored or transmitted in any form or by any means without the prior permission in writing from the copyright holder. Authorization to photocopy items for internal or personal use is granted by 21CAF Publishing. The articles in this conference proceeding remain in ownership of the authors.

Disclaimer: The publishers and editors cannot be held responsible for errors or any consequences arising from the use of information contained in this conference proceedings journal. The opinions expressed do not necessarily reflect those of the Publisher or Editors.

Mission: 21 Century Academic Forum is a global group of researchers and educators dedicated to supporting research that has the potential to influence the shaping of educational policy and practices to more effectively prepare students for the unique challenges of the 21st century.

Table of Contents

Arabic as a Foreign Language in the Nigerian Higher Education Curriculum: Problems, Solutions and Prospects <i>Kazeem O. Ajape</i>	1
Availability and Utilization of Electronic Resources by University Students in Niger State, Nigeria <i>Jibril A. Alhassan, Sharon O. Macaulay</i>	10
The Communication Styles Used by Networkers from UNO, Front Row and Aim Global within De La Salle University- Dasmariñas <i>Jan C. Austria</i>	21
Teaching Foreign Languages in Former Soviet Space - 21 st Century Georgian Practice <i>Ana Bakanidze</i>	31
The Leadership Qualities of University Librarians in Nigeria in the 21 st Century <i>Dr. Mohammed Abubakar Bitagi, Dr. Obaje Alfred Michael</i>	40
An Analysis of the Fictional Structure in Nineteen Eighty-Four <i>Hasan Çakir</i>	49
Gaming and Simulation in English Language Teaching: A Symbiotic Interweave Towards Language Efficiency <i>Manjusha Dhumal</i>	59
Level of Readiness of Selected Higher Educational Institutions in Region III to Offer a New Program for Physical Education <i>Anatalia Endozo, Jumel C. Miller</i>	65
Integrating Technology in the ESP Classroom in the Department of Biology- Tlemcen University (Algeria) <i>Faiza Haddam Bouabdallah</i>	76
Perceived Status of the Filipino Film Industry: Implications for Media Education <i>Isolde E. Valera</i>	85
Achievements of the EU Member States <i>Silvia Megyesiová, Vanda Lieskovská</i>	99
Lecturer Perception of Modern Technology Usage for the Teaching of Business Education Courses in Nigeria <i>Emeka G. Nwokocha</i>	107
Syntactic and Semantic Behaviour of the Ogba Article, Verb and Pronoun <i>Ben-Fred Ohia</i>	119
The Parameteric-Effects of the T-Movement, PSG and X-Bar Syntax on English and Ogbah <i>Henry Oburu Onyedibia</i>	130

Influence of Classroom Interaction Patterns on Student Achievement in Basic Electricity at Technical Colleges in Federal Capital Territory, Abuja <i>Owodunni A. Samuel</i>	144
The Collaborative Classroom: Digital Tools for Academic Writing <i>Richard Peel, Dawn Murray</i>	154
The English Language Needs of Different Stakeholders at Universitas Muhammadiyah Malang Indonesia: The Ethnographic Study <i>Dwi Poedjiastutie</i>	164
Enhancing Vocabulary Retention of Children with ADHD via Total Physical Response <i>Rajabi Peiman, Noori Masoome, Darakhani Leili</i>	175
Pedagogical Knowledge as a Way out of the Beginning ESL Teacher's Stress and Exhaustion <i>Rajabi Peiman, Darakhani Leili, Noori Masoome</i>	185
Impact of Permanent Vocabulary on Acquiring a New Language – An Empirical Evaluation <i>Kausar Saida, Yousuf Khan</i>	195
Trends in Library and Information Science Education in Nigeria in the 21 st Century <i>Katamba Abubakar Saka</i>	209
Sentiment Analysis and Education <i>Sandeep Srisharan Mukku, Nurendra Choudhary, Radhika Mamidi</i>	225
The Application of Rhetorical Differences to EFL Reading and Writing Education <i>Lihua Wang, Qinghua Wang</i>	231

Arabic as a Foreign Language in the Nigerian Higher Education Curriculum: Problems, Solutions and Prospects

Kazeem O. Ajape

Michael Otedola College of Primary Education
Noforija-Epe, Lagos State, Nigeria

Abstract

The study is concerned with the problem of how to improve the teaching of Arabic as a foreign language in Nigerian Higher Education System. The paper traces the historical background of Arabic education in Nigeria and also outlines the problems facing the language in Nigerian Institutions. It lays down some of the essential foundation-work necessary for bringing about systematic and constructive improvements in the Teaching of Arabic as a Foreign Language (TAFL) by giving answers to the following research questions: what is the appropriate medium of instruction in teaching a foreign or second language? What is the position of English language in the teaching and learning of Arabic/Islamic education? What is the relevance of the present curriculum of Arabic /Islamic education in Nigerian institutions to the contemporary society? A survey of the literature indicates that a revolution is currently taking place in FL teaching and that a new approach known as the Communicative Approach (CA), has begun to emerge and influence the teaching of FLs in general, over the last decade or so. Since the CA is currently being adopted to the teaching of most major FLs and since this revolution has not yet had much impact on TAPL, the study explores the possibility of the application of the CA to the teaching of Arabic as a living language and also makes recommendations towards the development of the language in Nigerian Institutions of Higher Learning.

Keywords: Arabic Language, Nigerian Institutions, Curriculum, Communicative Approach

Introduction

The Arabic language is the second language of every non- Arab Muslim, being the language supposedly acquired next to his mother tongue through the study of the Arabic Quran and later through other branches of Arabic and Islamic studies. In Nigerian context, Arabic is closely attached to all the Islamic knowledge disciplines within the Arabic school system. Therefore, the close relationship between Arabic and Islamic studies puts the language at the disposal of students learning it in this environment. And it is against this background that Muslims in Nigeria are committed to the course of Arabic and Islamic studies. Wherever there is a Muslim population, some kinds of Quranic and Advanced Arabic schools are established in which both Arabic and Islamic studies are studied simultaneously (Fafunwa, 1974).

Moreover, the early Arabic/Islamic education facilitated the first formal system of education in Nigeria. Many of the graduates from this early Islamic education furthered their studies in some of the ancient Islamic centers that later became some of the oldest Universities in the world (Fafunwa 1974). Among these early Islamic Universities are; the Qayrawan University in Fez, Morocco, the great al-Azhar University, Cairo established by the Fatimids of Egypt, Timbuktu also enjoyed the full accreditation of the scholars as the centre of Arabic and Islamic education in West Africa so also is the University of Az-zaytuni in Tunisia. In all these institutions, Arabic was the language of research, teaching and communication.

More so, these centres produced many of the early Muslim scholars in Nigeria and Africa in general. Some of the graduates of these centres came back to Nigeria and established Islamic centres while some of them were appointed as Qadis (Islamic jurist) some of them became administrators and translators for the traditional rulers of the former Islamic states (Galadanci 1982). It is pertinent to say that at the eve of the amalgamation of both the Northern and Southern provinces in 1912 C.E which later becomes what is known today as Nigeria, it was estimated that more than 19,000 Quranic schools with over 143,000 students flourishing in Northern Nigeria (Adesina 2011).

However, the first method of the introduction of the so-called secular subjects into Arabic and Islamic institutions was used in Katsina College in 1930 when the college broadened its curriculum by introducing science and other conventional subjects (Oloyede 2012). The Northern Provinces Law School was later established in 1934 by the Emirs of the Northern Nigerian under the auspices of the Colonial administrators for the purpose of training Islamic jurist that later became judges in the Sharia courts. The products of the school were the first set of Muslim scholars that were very conversant in both Western and Islamic education. The name of the school was later changed to School of Arabic Studies, Kano (al-Ilori, 1978)

English and Arithmetic were later taught in the school with other Arabic and Islamic subjects. This method assisted in the production of junior primary school teachers and it admitted students of ‘ilmiyah” schools who had never attended any conventional primary school. (Raji 2002) The opportunity created by this method paved way for the students to pursue their education up to university level in London, Cairo, Khartoum and Libya.(Mustapha 2001). According to Opeloye (1998), he notes that many of the top government functionaries today in Nigeria are products of that school; among them are the Grand Qadis, Chief justice, Secretaries in government functionaries, University Vice Chancellors and Professors. He observes that the lesson that should be learnt from this school system is that Institution of Islamic Education if organized to take cognizance of its immediate environment can be very useful to the society (Opeloye, 1998).

The Arabic Language in the Nigerian Higher Education Curriculum

The introduction of Arabic in the higher education curriculum was as a result of the establishment of the first University in Nigeria. This was the ultimate out-come of the Elliot commission set up by the British Government in 1943 to investigate on the organisation and facilities of the existing centres of higher education in the British West African colonies and to make recommendations regarding future university development in that area (Fafunwa 1972; Adesina, 2011). The result of the commission led to the establishment of the first University College in Nigeria which was formally opened in October, 1948 and named University College Ibadan an affiliate of University of London.

More so, the School of Oriental and African Studies in the University of London realised the establishment of University College Ibadan as an avenue to have access to many of the materials on the history of Africa that were written in Arabic language, hence this became the motive and the starting point of the introduction of Arabic language into the programmes offered by the University (Raji 2002; Ogunbiyi 2003; Abubakri 2002).

According to Ogunbiyi (2003), he highlights the factors that led to the inclusion of Arabic language in the curriculum of University of Ibadan. He opines that the first factor was as a result of the Universal Free Primary Education introduced by Government of the Western Region in 1955. This led to an increased need for teachers to handle various subject including Islamic Religious Knowledge and it was observed that there were no trained teachers to handle the subject except the products of the local Arabic schools, as result of this, certificate course in Arabic and Islamic studies were introduced to train those Arabic teachers. The Second factor was the growing awareness among the Nigerian historians of the importance of Arabic language to the study of the pre- colonial history of Africa while the third factor was the interest of the indigenous historians in the University that were favourably disposed to the establishment of Arabic language department in the University College led by Kenneth Dikke, a professor of history who later became the first Vice chancellor of the full-fledged University (Ogunbiyi, 2003).

As a result of this, the Department of Arabic and Islamic Studies was established in the University of Ibadan in 1962 and the first Head of the Department was John Hunwick a graduate of Arabic history from the School of Oriental and African Studies (SOAS), University of London. It is noteworthy to say that those that initiated the inclusion of Arabic language in the curriculum of the University College were all Christians among them are; John Hunwick, Kenneth Dikke, Sergeant and William Kensdale who was posted to the University as a librarian. He was interested in the collection of Arabic manuscripts from the immediate environment of the College and the rest of Nigeria. (Raji, 2002). This led to the establishment of the Centre for Arabic Documentation at the Institute of African Studies of the University. (Abubakri, 2002). This clearly shows that the mission of the inclusion of Arabic language in the curriculum of higher education in Nigerian system of education goes beyond the study of Islamic knowledge alone but it has wider objectives with a curriculum that was set up to meet those objectives.

Pertinent to say that the first graduates of the Department are Christians and they also diversified into different professions and became successful in their various fields of human endeavour. The Department has also produced a Christian professor in Arabic language and a Christian Doctorate degree holder in Arabic drama (Raji, 2002). Many of the products of the University have become Professors of Arabic and Islamic Studies in various Nigerian Institutions of higher learning. The twin subject was also introduced in 1963 at Abdullah Bayero College of the Ahmadu Bello University which was an offshoot of the School of Arabic Studies, Kano. Arabic and Islamic Studies Departments were later established in other Universities in Nigeria most especially in the Northern part of the country.

Teaching of the Arabic Language at Nigerian Universities at the Crossroads

The study of Arabic and Islamic studies in Nigerian institutions was plunged into a crisis in their bid to harmonise the intellectual gap between the modern secular education that emphasises modern knowledge and religious orientation of Arabic/Islamic education that emphasises religious sciences with the aim of producing an Islamic scholar. Raji (1988) asserts that the distinction between the secular and the Islamic education becomes more pronounced and the conflict climaxed in the universities with the introduction of Arabic and Islamic education at the University of Ibadan in 1961 and the twin subject was also introduced at Abdullah Bayero College of the Ahmadu Bello University in 1963. He cited an evidence from the paper presented by the former provost of Abdullah Bayero College at the University of Ibadan Arabic Seminar in which the Provost identified a host of problems most of which were rooted in this fundamental conflict. The provost asked the following questions:

The University was torn for example between meeting the secular demands of the University system and religious demand of Islamic education and those communities they were meant to serve. Should they adopt English in accordance with the University policy, as the medium of instruction in teaching Arabic / Islamic education instead of traditional Arabic language? Should the non-Muslim orientalist be employed to instruct? And their books recommended for use instead of Arabic textbooks in Arabic /Islamic education? (p.12)

Giving an answer to the questions stated above, Raji, (1988) gives kudos to Bayero University formerly Abdullah Bayero College. He asserts that the University has gradually overcome these secular forces that proved insurmountable for the University of Ibadan as a pioneer University. He notes that the University has consistently identified herself with the policy of Arabic/Islamic education, rather than secular policy of the University of Ibadan. He asserts that Arabic has continued to be used as medium of instruction with Arabic textbooks while the appointment of non-Muslim orientalist or the use of their books were totally discouraged in Arabic/Islamic education. At the same time, the syllabus drawn for the subject is not inferior to that of any Arab-Muslim university.

In contrary, Abdul-Rahmon (2008) demystifies the criticism against the involvement of non-Muslims in the teaching of Arabic/Islamic education in University of Ibadan. He asserts that the main factor that contributes to the underdevelopment of Arabic language in Nigerian institutions is the excessive theocentric perception of Arabic language. He maintains that the apathetic behaviour of the non-Muslim government officials and the generality of non-Muslims toward Arabic language which resulted in psychological hatred and fear arise from the Muslims' attitude of exclusiveness, in which many of the so-called modern Arabic/Islamic Scholars share this ridiculous sentiment.

This issue has become so much complicated between the Southern and Northern Universities, the former recognizes the secular policy of the university and English as medium of instruction while the latter insists on pure Arabic/Islamic traditional system of education and undiluted Arabic as the medium of instruction.

Therefore, there is need for reconciliation between the two schools of thought by putting into consideration the following fundamental questions that need to be addressed as far as this research is concern:

1. What is the appropriate medium of instruction in teaching a modern or second language?
2. What is the position of English language in the teaching and learning of Arabic/Islamic education?
3. What is the relevance of the present curriculum of Arabic /Islamic education in Nigerian institutions to the contemporary society?

Medium of Instruction in Teaching Modern Language

The most crucial aspect of teaching Arabic in Nigerian institutions of higher learning is the medium of instruction. The theoretical question that needs to be asked in this aspect is; can a foreign language be used to teach and learn another foreign language? In order to get an appropriate answer to this question different views and theories in teaching a foreign language were highlighted below.

The first thing that needs to be established is that in teaching second language, the language input (listening) must be higher than the level of language production expected of the pupils. This means that teachers need to develop the habit of speaking the language to the students several times for the students' listening, and this will gradually become meaningful to the hearing of the student. Chomsky (1975) developed a theory of language acquisition in which the learner is described as the generator of the language rules, to this extent his view is that learner develops acquisition of the target language through his own effort by joining what he heard together to pass a meaningful message.

This notion was also taken by Corder (1967) he argues that language errors made by students indicate the development of the underlying competences. Selinker (1972) referred to the learner's errors as the positive effort of learning new language. Krashen (1987) in his theory of communicative learning competence hold the view that language can be learnt or acquired. He believed that the process of language acquisition through communication is the best form of having good competence and proficiency of the target language. Bailey (1985) presents the results of classroom research on «the good language teacher». Some of the characteristics of outstanding teachers' lessons involved: More use of the target language by the teacher and the students combined, more teacher talk in the foreign language, more student talk in the foreign language and less student talk which is off the task.

Based on the views of the foreign languages experts stated above. It shows that the best methodology of teaching and learning a second or modern language is the communicative language teaching. This view has been upheld by the Modern Language Association as clearly stated by Burke (2011): she asserts that:

The Modern Language Association (MLA) Ad Hoc Committee on Foreign Languages advocated in a report that language majors at the university level "should become educated speakers who have deep trans lingual and transcultural competence," with the capability to operate between languages. Teachers would focus on students' ability to function as informed and capable interlocutors and use a more holistic cross-curricular approach to language learning and teaching. Students would understand the world and themselves through the lens of another language and culture (p.13)

Many researchers also hold the view that teachers of Modern language must always focus on communication in the classrooms, facilitate students' development of communicative competence and use a communicative approach to language teaching (CLT) (Burke, 2006, 2007; Savignon, 1997). According to Burke (2011) quoting Canale (1983) she asserts that the components of grammatical competence, discourse competence, strategic competence, and sociolinguistic competence offer a model of communicative competence as a basis for curriculum design and classroom practice. She concludes that this model closely resembles what the MLA committee (2007) emphasizes in its explanation of translingual and transcultural competence.

Therefore, teachers of a second or foreign language should always create a curriculum and instruction that promote students' development of communicative competence (Burke, 2006; Savignon, 1983, 1997). And must always take cognizance of the use of instructional methods

such as immersion, where both the teachers and students speak only the target language during class, and provide students with comprehensible input (Krashen, 1981).

The Position of English Language in the Teaching and Learning of Arabic/Islamic Education

It has been observed by many researchers that some teachers of Arabic language in Nigerian institutions of higher learning lack good mastery and communication of English language. (Oseni, 1988 ; Raji, 1999 ; Abdulrahim, 2009). Oseni, 1988 laments lack of confidence among the teachers of Arabic language because some of them find it difficult to express themselves in English and since the society is dominated with Western values in which English language is mainly used to transmit these values, therefore, the Arabic teachers that do not have good mastery of the language always exhibit inferiority complex, and in order to be accepted in their various schools, they become subservient to their boss and colleagues.

However, the importance of English language in Nigerian System of Education cannot be over emphasized. This is borne out of the fact that it is the Nigerian official language. It is also the second language and a medium of instruction in formal school system. Therefore, it is incumbent on both teachers and students at all level of Nigerian education system to have good mastery of the language. Abdul-Rahmon (2008) elucidates the importance of the acquisition of English language by the Arabic teachers as follows:

Proficiency in the Nigerian official language is of necessity for any Arabist/Islamist to function properly in the aspect of social integration. It is no secret that the disability of many of the Arabists in written and spoken English has hampered their efficiency. Such people become docile and reclusive in their place of work and as such become object of ridicule in most cases; hence they are incapable of defending their discipline when it is necessary to do so (p.10).

Moreover, the teaching of English language in Arabic/Islamic programmes should be done in such a way that it will not affect the standard of Arabic communication skill expected of the students studying the programme. Abdulraheem (2009) opines that English has not only replaced Arabic language in almost human endeavor but completely relegated it to background. He made an example of the situation in which the power of Arabic language has been withdrawn as a medium of instruction for Islamic studies, Islamic law, and even Arabic language. In which many institution are no more required knowledge or certification in Arabic before admission for Islamic related courses. Pertinent to say that there are some Arabic graduates that cannot converse effectively in Arabic language and some of them do not have good mastery of English language. This is as a result of the methodology applied by the individual university. The latter can be attributed to Arabic graduates from the Northern part of the country while the former is commonly noticed among the Arabic students from the Southern part of the country.

However, an intensive training in English language should be mounted for such students and the students themselves should make a concerted effort to master the communication of English language so that the erroneous believe of people about the poor English background of Arabic teachers as observed by Abdul-Rahmon (2008) and Oseni (1988) would be totally eradicated. This is also the stand of Oloyede (2012) when he observed that:

“From within and outside Nigeria indicate that in addition to deep knowledge in the Islamics, certain inter-personal and communication skills are necessary for effective delivery of the dividends of the twin subjects in a pluralistic setting such as Nigeria”.

More so, extra curriculum activities should always be organized for Arabic students that have low background of the language so as to improve their Arabic language efficiency. These may include; immersion and acculturation programmes, summer courses and visitation to the Arabic countries. Oderinde (2007) on this issue suggests that Arabic by Radio programme should be re-introduced in Nigerian broadcasting stations to enlightening non-Muslims that Arabic is not only for Muslims but a communicative tool like other foreign languages. Extra moral activities such as Arabic School Club, Arabic student' writing competitions and Arabic Banquet should be organized in all tertiary institutions with the support of Arabic speaking country embassies in Nigeria.

Relevance of the Present Curriculum of Arabic Education in Nigerian Institutions to the Contemporary Society

Critical observation of the present Arabic curriculum in Nigerian institutions shows that the content of the curriculum is too abstract and theoretical and many of the courses do not include practical skills that are relevant to the contemporary situation. The curriculum needs to be redesigned so that the students will have the ability of facing their future challenges in the aspect of economic, social, political, technological and intellectual advancement. All these are needed for their survival in the contemporary society. It was observed that the contents of the curriculum do not have any relationship with the intending professions of the students. When some students were asked about their future carrier, they chose professions like Arabic broadcasting, diplomacy, and bilingual translation. More so, the content does not have any specific purpose on vocational skills such as broadcasting, carrier diplomacy and entrepreneurship.

Moreover, these observations tend to agree with the views of other researchers in the field of teaching and learning Arabic language in Nigeria (Oladosu, 1986; Raji, 1996; Bidmos, 1996; Oloyede, 2003; and Oloyede, 2012). Oloyede (2003) asserts that the curriculum of the Arabic language and Islamic studies as a twin subject is unwittingly made abstract and theoretical, instead of its real nature as a practical way of life. Oloyede, (2012) expresses further that advanced training in Arabic or Islamic studies should incorporate some conventional disciplines such as official language of the immediate community of the learner, economics, elementary mathematics, political science, international relations, status and situation of Muslims in different parts of the world as well as the use of the computer. Therefore the present Arabic curriculum in Nigerian institutions needs total overhauling so as to be in conformity with needs of the students in order achieve the aims and objectives of teaching the language in Nigeria.

Conclusion

Nigerian education system in general is faced with multifaceted challenges resulting from the myriad of issues such as political, social and economic instability. It is therefore pertinent to say that with the amazing rates of change in the world today, there is need for readjustment in Nigeria educational curriculum from time to time to meet the societal demands of the global economy.

This study believes that a dynamic and progressive nation demands an education that will create sincerity and good life for its members. Therefore, to adjust to the changing time there has to be constant evaluation of the entire existing curriculum to ensure that they still meet the needs of the times. This will also go a long way to find everlasting solutions to some of the salient problems confronting the teaching and learning of Arabic language in Nigerian institutions of higher learning.

References

- Abdul-Raheem, H. I. (2008). Arabic as an alternative medium of education in Nigeria: Prospects and challenges. In Oseni, (Ed). *Fluorescence of Arabic and Islamic studies in Nigeria: festschrift in honor of Professor Wahab O.A. Nasiru*.
- Abdul-Raheem, H. I. (2009) The rivalry between English and Arabic in Nigeria education system: A need for curriculum reorganization. In Sanni & Muhibbu-din (Eds). *Transformation in Arabic and Islamic studies in Nigeria*. Studies in memory of Musa'AlliAjetunmobi .Ijebu-Ode: Shebiotimo Publications.
- Abdul-Rahmon, M. O. (2008) Perspectives in the teaching and learning of Arabic and Islamic studies in South-West of Nigeria. In Oseni (Ed), *Fluorescence of Arabic and Islamic studies in Nigeria: festschrift in honor of Professor Wahab O.A.*
- Abubakare, R. D. (1984). The future of Arabic learning in Yoruba land. *Ilorin Journal of Education*, 4, p.30-43
- Adesina, S. A. (2011). *Planning and educational development in Nigeria*. Educational Industries Nigeria Ltd: Lagos, Nigeria
- Al-Ilori, A, A. (1978). *Al-Islam fi NajjiriyawaShykh 'UthmabbnFodio*. Al-Fulani.: Markaz Press.
- Bailey, K. M. (1985). Classroom-centered research on language teaching and learning. In (Celce-Murcia, M. (Ed.) *Beyond Basics: Issues and Research in TESOL*. Rowley, Mass.: Newbury House.
- Bidmos, M. A. (1988) In quest of methodology of teaching Arabic language in Nigeria. In Opeloye. (Ed) Arabic and Islamic studies in Nigerian schools: challenges of the 6- 3-3-4 system. *Journal of Nigerian Association of Teachers of Arabic and Islamic Studies*. Vol VI., No. ii, Pg 1-9
- Burke, B. M. (2011). Rituals and beliefs ingrained in world language pedagogy: Defining deep structure and conventional wisdom. *Journal of language teaching and research*, 2(1), p.1-12.
- Chomsky, N. (1975). *Reflection on language*. New York: Pantheon books
- Corder, S.P. (1967). The significance of Learners' Error. *International Review of Applied Linguistics*, 5.
- Fafunwa, A. B. (1974). *History of education in Nigeria*. London: George Allen & Unwin.
- Fonchairo, M., & Bonomo, M. (1973). *The foreign language learner*. New York: Regent Publishing.
- Galadanci, S. A. S. (1982). *Harakat al-Lughat al-'ArabiyyahwaAdabiha fi Najjiriya*. Cairo: Dar al-Ma'arif.
- Krashen, S. D. (1981). *Second language acquisition and second language learning*. Oxford: Pergamon.
- Lawal, A. I. (2007). *Of tongue and its numerous "faces" the history of Arabic in Nigeria*. Lagos: LASU Press
- Modern Language Association. (2007). Foreign languages and higher education: New structures for a changed world [online]. Retrieved from <http://www.mla.org/flreport>, Dec. 3, 2012
- Mustapha, A. (2001). Sabotage in patronage Islamic education under Colonial rule in Nigeria. In *Journal of Nigerian Association of Teacher of Arabic and Islamic Studies (NATAIS)*, 6(1).
- Nasiru, Akare, R. D. (2002). *Survival of Arabic in difficult terrains*. Ilorin: Unilorin Press.
- Oderinde, B. O. (2007). *English and Arabic curriculum context: Benefits to Nigerian society*. Lagos: Lagos State University Press
- Ogunbiyi, I. A. (2003). An unfamiliar guest in a familiar household. *Perspectives in Religious Studies*, 1, p. 89-99.
- Oloyede, I. O. (2003).The Place of Arabic and Islamic Studies in a Globalized Nation. Being a Commissioned Paper Presented at the Formal Opening Ceremony of the National Conference of Nigeria Association of Teachers of Arabic & Islamic Studies (NATAIS) held in Lagos on the 31 st of December, 2003 (9th of DhulQ'adah 1424 A'H)
- Oloyede, I. O. (2012) Arabic and Islamic studies in Nigerian universities: trends, development and challenge. Being a paper presented at the University of Ibadan on the occasion of the formal opening of the 2012 International Conference on Arabic/Islamic Studies in Nigeria (11th – 13th April, 2012)

- Opeloye, M. O. (1988) Teaching of Islamic studies at the junior and senior secondary school levels within the 6-3-3-4 educational structure. In Opeloye (ed) Arabic and Islamic studies in schools: challenges of the 6- 3- 3- 4 system. Journal of Nigerian Association of Teachers of Arabic and Islamic Studies. Vol IV, No II
- Oseni, (1988). Teaching Arabic Literature at the Senior Secondary Level in Nigeria: Problems and Methodology. In (Opeloye. Ed) Arabic and Islamic studies in schools: challenges of the 6- 3- 3-4 system. *Journal of Nigerian Association of Teachers of Arabic and Islamic Studies*, 6(2).
- Raji, M. G. A. (1988) Arabic and Islamic Education in the Context of National Policy on Education in Nigeria. In Opeloye. (Ed) Arabic and Islamic Studies in Schools: Challenges of the 6- 3-3-4 system. Journal of Nigerian Association of Teachers of Arabic and Islamic Studies. Vol VI, No II pg. 47-55
- Raji, R, A. (2002) Tangled Complexities: Muslim – Christian Relations and the Issue of the Arabic Language in Nigeria. Ilorin: University of Ilorin Press.
- Riccardo, S. V, (1999) Research on the Good Teacher. ESPOS XV. Retrieved from e-spacio.united.es/fez/serv.php. on March 23, 2012
- Richardson, V. (1996) The roles of attitudes and beliefs in learning to teach. In J. Sikula, T. J. Buttery, & E. Guyton (Eds.), *Handbook of Research on Teacher Education* (2nd ed., pp. 102-119). New York: Macmillan
- Sanderson, D, (1983) Classroom-Centered Research on Language Teaching and Learning in Celamuricat (Ed) *Beyond Basics: Issues and Research in TESOL*, Rowley Mass., Newbury House
- Savignon, S. (1997) Communicative Language Teaching: State of the Art. *TESOL Quarterly* 25 (2), 261-277
- Selinker, C. (1972). Interlanguage. *International Review of Applied Linguistics*, 10, 25- 33

Availability and Utilization of Electronic Resources by University Students in Niger State, Nigeria

Jibril A. Alhassan and Sharon O. Macaulay

Federal University of Technology,
Department of Library and Information Technology
Minna, Nigeria

Abstract

This study was carried out to determine the types of e-resources available, the awareness about them and their use by university students in Niger State of Nigeria. Descriptive survey design was used for the study. The population of the study comprised the 20,000 undergraduate students of two universities in Niger, namely Federal University of Technology, Minna and Ibrahim Badamasi Babangida University Lapai. A simple random sampling technique was used to select 200 respondents from the two universities. Collected data were analysed using a frequency count and simple percentages. Findings revealed that the Internet services, e-mail services, online databases, and electronic databases were the available electronic information resources often used by the undergraduate students in both universities. The use of the e-resources enables the undergraduates to have access to current and up-to-date information, faster and easier access to information, and access to a wider range of information. The students used the resources for academic purposes, online application/registration, research, communication with friends and colleagues, sourcing of materials for project writing, completing assignments, and for other personal purposes. However, inadequate power supplies, and poor network/internet connectivity, were major constraints. The study recommends that universities should give priority to the development of Information and Communication Technologies in the library by subscribing to relevant educational databases. Information retrieval skills, using information technology, should be included in the curriculum for undergraduate students so that they can make use of these electronic resources effectively. Hands-on training on the use of these resources should be actively promoted.

Keywords: Electronic Resources; Utilization; University Students; Nigeria

Introduction

Libraries have been part and parcel of human civilization because the art of writing and preservation of knowledge is an integral part of human culture and civilization. Libraries have thus gone through tremendous developments and transformation over the years. One of the major aspects of human civilization is that humans adopt technology to develop libraries, all in an effort to preserve human experience. Thus librarianship helps to preserve and make widely accessible the records of human experience. Information Technology is the technology of the 21st century which started to manifest and transform in the later part of the 20th century. The emergence of Information Technology (IT) has re-directed the practice of librarianship.

The advent of Information and Communication Technology (ICT) has accelerated the availability and use of electronic resources in academic libraries because of high demand for relevant information by faculty members and students. In order to meet such demand, libraries and librarians have to address their role and position in relation to this global development. Thus, academic libraries now invest heavily in electronic resources.

In academic libraries, the electronic resources that are of critical importance for use are e-journals and e-books, because they are the e-version of the conventional books and journals found in the library. These e-resources are stored and organized in various databases to permit easy retrieval. Some of these databases are subject-based while others cover a wide range of subject areas. Publishers often have their own databases with all their publications while other agents collate publications from various databases to provide robust access to e-resources.

Students constitute the largest percentage of library users in universities. The advent of electronic resources, accessible by remote means using various facilities, has created a level of convenience for students in using library facilities that are e-based. However, it has been observed that the patronage of e-resources by students especially in the Federal University of Technology, Minna is still low. Similarly, Adeniran (2013) found that students of Redeemers University, Nigeria were aware of the different types of electronic information resources available in the university library; their use rate of these resources is low. It is against this backdrop that this study investigates the utilization of e-resources by university students in Niger State.

The present dispensation of library and information services has put every librarian on alert to be able to meet the demands of the varied clientele. This is as a result of a shift from traditional printed material provision to a hybrid service where both the print materials and the electronic sources are provided concurrently, especially in university libraries. In fact, the growth and diversity of electronic resources, especially e-journals, has led many to predict the extinction of printed journals. According to Shuling (2007), electronic information has gradually become a major resource in every university library in recent years. Kinengyere (2007, P.328) has stated that “the impact of moving from text-based to resource-based learning has involved heavier use of library materials and a demand for more and varied media sources” This makes the provision and use of electronic information systems in academic libraries a critical issue for those working in information and library services (Armstrong et al., 2001).

Literature Review

Tella et al. (2007) has noted that students’ ability to find and retrieve information effectively is a transferable skill useful for their future lives as well as enabling the positive and successful use of academic electronic resources. The ability to explore the digital environment is a requirement for academic success today. Students are increasingly expected to use electronic information resources at the university. In order to make use of the growing range of electronic resources, students must acquire and practice the skills necessary to

exploit them. Learning such skills is essential in a technology driven environment, and this can be enhanced through the use of innovative learning strategies (Lawson, 2005).

Okello-Obura and Magara (2008) investigated electronic information access and utilization at the East African School of Library and Information Science, Makerere University, Uganda. The study revealed that users derived many benefits from electronic resources as they gained access to a wider range of information, and their academic performance improved as a result of access to quality information.

Madhusudhan (2007) conducted a study on internet usage by research scholars in the University of Delhi and the results indicated that the problems encountered included an inadequate number of computers with internet facilities, slow internet connections, and lack of skills and training. Watts and Ibegbulam (2006) examined some of the barriers to the usage of electronic information resources available at the medical library of College of Medicine, University of Nigeria, Nsukka. Their findings revealed that lack of inadequate ICT infrastructure and affordable online access, absence of in-depth ICT skills and information searching skills among library staff, and cost of using the cybercafé were barriers to the use of electronic resources.

Oduwole and Akpati (2003) investigated the accessibility and retrieval of electronic information at the University of Agriculture Library, Abeokuta, Nigeria, and they reported that electronic information is relevant to all members of the University community, that it was increasingly easy to use, and that most staff members were satisfied with their search outputs. The constraints identified included insufficient number of terminals available for use, despite high demand, and inadequate electricity supply.

Ojo and Akande (2005) reported a low level of usage of electronic information resources by students in their study of access, usage and awareness of electronic information resources at the University College Hospital (UCH) Ibadan, Nigeria. The major problem identified was a lack of information retrieval skills for exploiting electronic resources, thus making the level of usage of resources by medical students very low.

Based on the findings in this prior research, it is considered imperative to study the availability and utilization of electronic resources by undergraduate students in the two universities located in Niger state in the North central part of Nigeria.

Objectives of the study

The objectives of the study were to:

- 1 Determine the types of e-resources available in university libraries in Niger State.
- 2 Determine the level of awareness of e-resources and how often they are being used by students
- 3 Determine the overall rate of use of the e-resources.
- 4 Explore the impact of e-resources on students' academic achievement in universities in Niger State.
5. Explore the challenges of using e-resources by university students in Niger State.

Research methodology

A survey research design was used in this study. The population of the study comprised 20,000 undergraduate students of Federal University of Technology (FUT), Minna and Ibrahim Badamasi Babangida University (IBBU), Lapai, both in Niger state, Nigeria. Two hundred (200) students, that is, 100 from each of the two universities, were sampled for the study using a simple random sampling technique. Structured questionnaires were used for data collection and then analysed using a frequency count and simple percentages.

Data analysis and interpretation

Distribution and return of questionnaire

Out of the total of 200 copies of the questionnaire distributed, 130 were completed, returned and found useful, representing a 65% return rate.

Table 1: Distribution of respondents by Institution and gender

Item	Frequency	Male	Female
F.U.T Minna	66 (51%)	46 (70%)	20 (30%)
IBBU Lapai	64 (49%)	36 (56%)	28 (44%)
Total	130 (100%)	82 (63%)	48 (37%)

Table 1 reveals that 66(50.77%) of the respondents were from FUT Minna while 64 (49.23%) were students from IBBU Lapai. The table also shows that 82 (63%) of the respondents were male while 48 (37%) were female. The high number of male respondents over females can be attributed to the lackadaisical attitude to girl child education in northern Nigeria, which are in turn due to cultural and religious inclinations.

Table 2: Computer literacy of respondents

OPTION	FUT MINNA	IBBU LAPAI	TOTAL	PERCENTAGE
YES	60	53	113	87
NO	6	11	17	13
Total	66	64	130	100

Table 2 shows that a large number of respondents were computer literate, that is, 113 respondents, representing (87%), while 17 (13%) of the respondents were not computer literate. The high rate of computer literacy can be attributed to the fact that the Nigerian labour market requires graduates to be computer literate.

Table3: Awareness of the electronic resources in your institution's library

OPTION	FUT MINNA	IBBU LAPAI	TOTAL	PERCENTAGE
YES	60	56	116	89
NO	6	8	14	11
Total	66	64	130	100

In Table 3, it is shown that 116 respondents, representing 89%, were aware of the electronic resources in their institution's library while 14 (11%) respondents were not. This implies that the majority of the respondents were aware of the electronic resources in their institution's library.

Table 4: The electronic resources available in your institution's library

OPTION	FUT YES	IBBU YES	Overall count & Percent for Yes	FUT NO	IBBU NO	Overall count & Total Percent for No
CD-ROM Databases	13(10%)	25 (19.23%)	29.23%	53 (40.77%)	39 (30%)	70.77% 130(100%)
Internet services	66 (50.77%)	64 (49.23%)	100%	-	-	- 130(100%)
E-mail services	59 (45.38%)	58 (44.62%)	90%	7 (5.38%)	6 (4.62%)	10% 130(100%)
Electronic journals	49 (37.69%)	39 (30%)	67.69%	17 (13.08%)	25 (19.23)	32.21% 130(100%)
Online Public Access Catalogue (OPAC)	21 (16.15%)	23 (17.69%)	33.84%	45(34.62%)	41(31.54%)	66.16% 130(100%)

Online databases	51 (39.23%)	41(31.54%)	70.77%	15 (11.54%)	23(17.69%)	29.23% 130(100%)
Electronic books	11 (8.46%)	20 (15.38%)	23.84%	55 (42.31%)	44(33.85%)	76.16% 130(100%)

Table 4 shows that eBooks (23.84%), CD-ROMs (29.23%) and OPAC (33.84%) are perceived to be unavailable to respondents in their university libraries, based on the low percentage of respondents that answered yes to their availability. Over 60% of the respondents affirmed that the resources were not available. All the other resources, namely internet services, email services, e-journals, and online database were attested to be available by respondents with an affirmative response of over 65%.

Table 5 : You make use of electronic resources

OPTION	FUT MINNA	IBBU LAPAI	TOTAL	PERCENTAGE
YES	63	59	122	93.85
NO	3	5	8	6.15
Total	66	64	130	100

Table 5 shows that 93.85% (122 respondents) from both universities indicated that they used the electronic information resources, while only 8 (6.15%) respondents indicated that they did not use electronic resources. This implies that electronic resources are used by most respondents.

Table 6: You prefer the printed resources over the electronic resources

OPTION	FUT MINNA	IBBU LAPAI	TOTAL	PERCENTAGE
YES	30	20	50	38.46
NO	36	44	80	61.54
Total	66	64	130	100

In Table 6, 38.46% (50) respondents indicated a preference for using printed materials over electronic resources, while a majority of the respondents (80, or 61.54%) preferred printed resources over electronic resources. This implies that both printed and e-resources were used by respondents, with e-resources enjoying a preference over printed sources.

Table 7: You use the following electronic resources

S/N	OPTION	FUT		Total	IBBU		Total
		YES	YES		NO	NO	
1	CD-ROM Databases	21 (16.15%)	20 (15.38%)	31.53%	45 (34.62%)	44(33.85%)	68.47%
2	Internet services	66 (50.77%)	61 (46.92%)	97.69%	-	3 (2.31%)	2.31%
3	E-mail services	57 (43.85%)	54 (41.54%)	85.39%	9 (6.92%)	10 (7.69%)	14.61%
4	Electronic journals	38 (29.23%)	35 (26.92%)	56.15%	28 (21.54%)	29 (22.31%)	43.85%
5	Online Public Access Catalogue (OPAC)	32 (24.62%)	26 (20%)	44.62%	34(26.15%)	38 (29.23%)	55.38%
6	Online databases	40 (30.77%)	39 (30%)	60.77%	26 (20%)	25 (19.23%)	39.23%
7	Electronic books	50 (38.46%)	45 (34.62%)	73.08%	16 (12.31%)	21 (16.15%)	28.46%

Table 7 indicated that internet services (97.69%), e-mail services (85.39%), and electronic books (73.08%), are used by over 70% of the respondents. Online databases (60.77%) and electronic journals (56.15%) are used by 55-65% of the respondents, while Online Public Access Catalogues (44.62%) and CD-ROM databases (31.53%) were used by less than 50% of the respondents. This implies that all the resources are used to some extent, but the most used are internet services, email services, e-books, and online databases with 60% and above.

Table 8: Frequency of using the electronic resources

Option	FUT	IBBU	Total	Percentage
Daily	18	24	42	32.31%
Weekly	22	17	39	30%
twice a week	6	9	15	11.54%
Monthly	20	14	34	26.15%
Total	64	64	130	100%

Table 8 revealed that 42 (32.31%) of the respondents made use of electronic resources daily, 39 (30%) of the respondents used the electronic resources weekly, 15 (11.54%) made use of electronic resources twice a week, while 34 (26.15%) respondents made use of electronic resources monthly. This implies that the frequency of use is high with 62.31% of the respondents using it either daily or weekly.

Table 9: Frequency of the use of electronic resources

Option	Very often	Often	Occasionally	Rarely
CD-ROM Databases	-	26(20%)	48(36.92%)	56(43.07%)
Internet services	62(47.69%)	47(36.15%)	21(16.15)	-
E-mail services	54(41.53%)	39(30%)	30(23.07%)	7(5.38%)
Electronic journals	31(23.84%)	16(12.30%)	52(40%)	32(24.61%)
OPAC	-	-	57(43.84%)	73(56.15%)
Online databases	27(20.76%)	39(30%)	35(26.92%)	29(22.30%)
Electronic books	57(43.84%)	48(36.92%)	17(13.07%)	8(6.15%)

Table 9 showed that internet services were the most frequently used as 62 (47.69%) respondents very often used it. This was followed by electronic books 57 (43.84%) and email services as affirmed by 54 (41.53%). Others were electronic journals 31(23.84%) and online databases 27 (20.76%). CD-ROM and OPAC were not frequently used by respondents. The table further revealed that electronic books were often used by 48 (36.92%), while 47 (36.15%) often used internet services, 39 (30%) often used email services and online databases, 26 (20%) often used CD-ROM databases and 16 (12.30%) often used electronic journals. OPAC was not often, but occasionally used by 57 (43.84%) respondents. Electronic journals were occasionally used by 52 (40%) respondents and CD-ROM by 48 (36.9%) respondents. The other four resources were online databases 35 (26.92%), email services 30 (23.07%), internet services 21 (16.15%), and electronic books 17 (13.07%). In the rarely used column, OPAC showed 73 (56.15%), CD-ROM 56 (43.07%), electronic journals 32 (24.61%), and online databases 29 (22.30%). However, while no respondents rarely used the internet services, only 8 (6.15%) and 7 (5.38%) rarely used electronic books and email services respectively.

The analyses of the table imply that internet services, eBooks and email services were the most frequently used electronic resources while OPAC and CD-ROM were the least frequently used. Furthermore, the fact that respondents were undergraduates could account for the more frequent use of electronic books when compared to electronic journals.

Table 10: Benefits from the use of e-resources

	Electronic Resources	YES	Percentage	NO	Percentage
a.	Access to a wider range of information	130	100%	-	-
b.	Faster access to information	127	97.69%	3	2.31%
c.	Access to current up-to-date information	120	92.31	10	7.69%
d.	Easier access to information	98	75.38%	32	24.62%
e.	Improved academic performance as a result of access to quality information.	122	93.85%	8	6.15%

Table 10 showed that all the respondents 130 (100%) confirmed that they had access to a wider range of information, 127 (97.69%) respondents indicated faster access to information, and 120 (92.31%) respondents indicated current and up-to-date information. Meanwhile, 98 (75.38%) indicated that they had easier access to information as a result of the use of electronic information resources while the majority of respondents (122, or 93.85%) reported that the use of the electronic resources improved their academic performance as a result of access to quality information.

This result implies that the benefits derived from the use of the electronic information resources by the undergraduate students in both FUT Minna and IBBU Lapai were significant and they included: access to current and up-to-date information, faster access to information, access to a wider range of information, and easier access to information.

Table 11: Purpose of using e-resources

OPTION	YES		Total	NO		Total
	FUT	IBBU		FUT	IBBU	
Academic purposes/ course works	59	55	114 (87.69%)	7	9	16 (12.31%)
Complete assignment	46	50	96 (73.85%)	20	14	34 (26.15%)
For research purposes	50	48	98 (75.38%)	16	16	32 (24.62%)
Communication with friends and colleagues	61	54	115 (88.46%)	5	10	15 (11.54%)
Online application/ registration	37	46	83 (63.85%)	29	18	47 (36.15%)
Sources for materials for project writing	65	58	123 (94.62%)	1	6	7 (5.38%)
Personal	48	50	98 (75.38%)	18	14	32 (24.62%)

Table 11 shows various purposes for which the respondents used the electronic information resources. The Table shows that most of the respondents 114 (87.69%) used the electronic resources for academic purposes/course work, 96 (73.85%) of respondents used the electronic resources for assignments, 98 (75.38%) of respondents used it for research purposes, 115 (88.46%) of respondents used it to communicate with friends and colleagues, and 83 (63.85%) of respondents used electronic resources for online application/registration. Almost all the respondents 123 (94.62%) used the electronic resources as sources of information for project writing and 98 (75.38%) of the respondents used the electronic resources for other personal purposes.

Table 12: factors that hinder the use of electronic resources

Factors that Hinder Electronic Resources Use	Yes		Total	NO		Total
	FUT	IBBU		FUT	IBBU	
Too much information retrieved	23(17.69%)	18(13.85%)	41(31.54%)	43(33.08%)	46(35.38%)	89(68.46%)
It is time consuming	18(13.86%)	28(21.54%)	46(35.4%)	48(36.92%)	36(27.69%)	94(64.61%)
Access to computer terminal is Limited	46(35.38%)	39(30%)	85(65.38%)	20(15.38%)	25(19.23%)	45(34.61%)
No IT knowledge to effectively utilize the services	50(38.46%)	42(32.31%)	92(70.77%)	16(12.31%)	22(16.92%)	38(29.23%)
Using electronic resources often distracts me from doing my other work	33(25.38%)	38(29.23%)	81(54.61%)	33(25.38%)	26(20%)	59(45.38%)
Library staff don't assist to use	48(36.92%)	40(30.77%)	88(67.69%)	18(13.86%)	24(18.46%)	42(32.32%)
The system is sometime slow	66(50.77%)	64(49.23%)	130(100%)	-	-	0(0%)
Sometime there is network failure	59(45.38%)	59(45.38%)	118(90.76%)	7(5.38%)	5(3.85%)	12(9.23%)
Power failure	38(29.23%)	45(34.62%)	83(63.85%)	28(21.54%)	19(14.62%)	47(36.16%)

Table 12 shows that 41 (31.54%) of respondents indicated that too much information retrieved hindered electronic resources use, while 89 (68.46%) of respondents indicated that too much information retrieved did not hinder use of electronic resources. 46 (35.4%) of respondents were of the opinion that time consumption hindered electronic resources use while 94 (64.61%) of the respondents had the opposite opinion. As for limited access to computer terminals being a hindrance to electronic resources use, 85 (65.38%) of respondents stated yes, while 45 (34.61%) of respondents stated no. 92 (70.77%) of respondents responded that a lack of IT knowledge to effectively utilize the services hindered usage of electronic resources use, while 38 (29.23%) indicated it did not. Also, 81 (54.61%) of respondents responded that using electronic resources often distracted them from doing their work, while 59 (45.38%) of respondents disagreed with this. 88 (67.69%) of respondents agreed that non-assistance from library staff to facilitate easy access hindered electronic resources, while 42 (32.32%) of respondents responded that non-assistance from library staff did not hinder their use of electronic resources. All the respondents (130, or 100%) agreed that the slow system sometimes hindered use of electronic resources. Almost all the respondents, representing 118 (90.76%), agreed that sometimes there was network failure, which hindered use of electronic resources. However, 83 (63.85%) of respondents agreed that power failure hindered use of electronic resources, while only a few respondents (47, or 36.16%) said that power failure did not hinder usage of electronic resources.

Discussion of results

It was revealed by the findings of this study that Internet services, e-mail services, online databases, electronic databases, and electronic journals were available for the use of respondents in both Federal University of Technology Minna and Ibrahim Badamasi Babangida Lapai. However, other electronic resources like CD-ROM databases, Online Public Access Catalogue (OPAC), as well as electronic books, were not readily available for their use.

The results also show that some of the available electronic resources like the internet, e-mail, online databases, electronic databases and electronic journals were highly used by the

respondents in the two universities, while others like CD-ROM databases, electronic journals, Online Public Access Catalogue (OPAC) and electronic books were rarely used.

The findings suggest that the benefits of using the electronic resources by the respondents were enormous and included access to current and up-to-date information, faster and easier access to information, improved academic performance as a result of access to quality information, and access to a wider range of information. This corroborates findings by Okello-Obura and Magara (2008) who investigated electronic information access and utilization at the East African School of Library and Information Science, Makerere University, Uganda. Their study suggested that users derived many benefits from electronic resources by gaining access to a wider range of information, and this improved academic performance as a result of access to quality information. Furthermore, the study also revealed that the undergraduate students used the electronic resources for various purposes, such as online application/registration, research, communication with friends and colleagues, sourcing materials for project writing, completing assignments, and for other personal purposes.

The major constraints, as found by this study, were limited access to computer terminals, lack of IT knowledge to effectively utilize the services, poor internet connectivity, and power failure.

Conclusion

Based on the findings of the study, the following conclusions are drawn:

- Electronic information resources like internet, e-mail services, online databases, electronic databases, and electronic journals were available for use in both Federal University of Technology Minna and Ibrahim Badamasi Babangida University Lapai.
- The resources were often used by undergraduates to support their academic course work, online application/registration, research, communication with friends and colleagues, sourcing materials for project writing, completing assignments, and for other personal purposes.
- The use of these resources by the students resulted in a number of benefits such as access to current and up-to-date information, faster and easier access to information, and access to a wider range of information.
- The study also established that the use of electronic information resources by undergraduate students in the two universities was very encouraging. Inadequate power supply, inadequate provision of key electronic resources and facilities in the library were identified as key factors militating against the effective use of the electronic information resources.

Recommendations

The following recommendations are made, based on the findings of this study.

1. Universities should give priority to the development of Information and Communication Technologies in the library by subscribing to relevant educational databases.
2. Information retrieval skills using information technology should be included in the curriculum for the undergraduate students to be able to make use of these electronic resources effectively. Hands-on training on the use of these resources should be actively promoted.

References

- Adeniran, P. (2013). Usage of electronic resources by undergraduates at the Redeemer's University, Nigeria. *International Journal of Library and Information Science* 5(10), 319-324. Available at <http://www.academicjournals.org/IJLIS>
- Armstrong, C. et al. (2001). A Study of the use of electronic information systems by higher education students in the UK. *Program: electronic library and information systems*, 35(3), 241-262.
- Kinengyere, A. A. (2007). The effect of information literacy on the utilization of electronic information resources in selected academic and research institutions in Uganda. *The Electronic Library*, 25(3), 328-341.
- Lawson, K. G. (2005). Using eclectic digital resources to enhance instructional methods for adult learners. *OCLC Systems & Services: International Digital Library Perspectives*, 21(1), 49-60.
- Madhusudhan, M. (2007). Internet use by research scholars in University of Delhi, India. *Library Hi Tech News*, 8, 36-42.
- Oduwole A. A., & Akpati, C. B. (2003). Accessibility and retrieval of electronic information at the University of Agriculture Library Abeokuta, Nigeria. 52(5), 228 – 233, Available at: <http://www.emeraldinsight.com/researchregister>.
- Ojo, R. A. & Akande, S. O. (2005). Students access, usage and awareness of electronic information resources at the University College Hospital, University of Ibadan, Nigeria. *Lagos Journal of Library and Information Science*, 3(1), 16 – 24.
- Okello-Obura, C. & Magara, E. (2008). Electronic information access and utilization by Makerere University Students in Uganda. *Evidence Based Library and Information Practice*, 3(3).
<https://ejournals.library.ualberta.ca/index.php/EBLIP/article/viewPDFInterstitial/935/3328>
- Shuling, W. (2007). Investigation and analysis of current use of electronic resources in University Libraries. *Library Management*, 28(1), 72-88.
- Tella, A. et al. (2007). Self-efficacy and use of electronic information as predictors of academic performance. *Electronic Journal of Academic and Special Librarianship*, 8(2, Summer). Retrieved 11 Jan. 2009 from http://southernlibrarianship.icaap.org/content/v08n02/tella_a01.html
- Watts, C., & Ibegbulam, I. (2006). Access to electronic healthcare Information Resources in developing countries: Experiences from the medical library, College of Medicine, University of Nigeria. *IFLA Journal*, 32(54). Retrieved May 15, 2010 from <http://ifl.sagepub.com/content/32/1/54.full.pdf+html>. Retrieved 17th of June 2012.

The Communication Styles Used by Networkers from UNO, Front Row and Aim Global within De La Salle University- Dasmariñas

Jan C. Austria

De La Salle University- Dasmariñas
Communication and Journalism Department
Dasmariñas, Cavite, Philippines

Abstract

The emerging industry of multi-level marketing or also known as “networking” has acquired the title “The Business of the 21st Century.” With the present economy of the Philippines, many of its people find it ideal to enter into this kind of business since the rate of unemployed and underemployed is increasing, thus, it capitalizes the word job. In recruitment and direct selling, the networkers use communication as their most prominent tool. The main objective of this study is to discern the top 3 communication styles that were used by the top 3 filipino-owned networking companies such as Unlimited Networks of Opportunities (UNO), FrontRow and Alliance in Motion Global (AIM Global) in De La Salle University-Dasmariñas. The study was limited to verbal communication styles. The study used qualitative method to undermine the selected companies. The researchers gathered data through in-depth and semi-structured interview with the top earners of selected networking companies. The researchers observed, interacted and participated together with audio recordings and detailed journals in the process of recruitment. Furthermore, this study also uncovered how these networkers use the communication styles and their methods of persuading their prospects to join the company.

Keywords: Multi-level Networking, Communication Styles, Persuasion

Introduction

Communication is a vital process in the lives of every human being. The way people communicate determines the success and failure of our goals. As there are a lot of nuances in human communication, it became more multifaceted, diverse and has numerous intentions. Communication serves as a tool with which, has influence on others, bring out changes in attitudes, motivate the people around and establish and maintain relationships with them. With regards to influencing and motivating, the communication in the field of network marketing industry is known. They have been using this viewpoint of communication to gain profit and endure the struggles in the business world.

On Network Marketing

Network marketing is a type of business opportunity that features a low upfront investment and the opportunity to sell a product directly to friends, families, and other personal contacts by means of relationship referrals and word of mouth. The sales force is compensated not only for sales they generate, but also for the sales of the other salespeople that they recruit. (*Xardel, 1993*). Most network marketing programs also ask participants to recruit other sales representatives (*Mcquail, 1994*). This recruited sales force is referred to as the participant's "downline", and can provide multiple levels of compensation (*Xardel, 1993*).

There are right ways and strategies on how to gain attention and trust every person in order to persuade them in joining networking business (*Go and Escareal-Go, 2011*). This includes the physical presentation that attains the charisma, approaching an individual through a small talk to something worthy and interrelation of each party. In these processes, it enables a situation to box the person's thinking and focus on the positivity (*Templeton et al., 2005*).

With them, the power of speech comes the power of persuasion or the capability to influence others to assent an idea, a point, a view or a proposal. They should project knowledgeability, buoyancy and authenticity. It appeals not only to the intellect but to the emotions as well (*Villamazo, et al., 2000*). In their efforts to present their best and most persuasive self, one may attempt an impression of maturity, assurance and trustworthiness by an appropriate front, dramatic realization and mystification (*Ross, 1995*).

Persuasion represents a conscious attempt to influence the other party, along with an accompanying awareness that the persuadee has a mental state that is susceptible to change. One can't force people to be persuaded; one can only activate their desire and show them the logic behind your ideas. Their devotion and total commitment to an idea come only when they fully understand and buy in with their total being (*Whalen, 1996*). The language used by the networkers is an important matter in order to persuade people in buying their products. Meaning, the effective techniques applied to maintain good image in the company with their goods and services are done through the word of mouth (*Grose, 2010*).

On Communication Styles

In building a successful network marketing business, analyzing just the words spoken on an exchange will be useful in figuring out "how" something is said since people tend to react to different styles intuitively and impulsively (*Newton, 2015*). It is not always about the content but in which way it was discussed, conversed, queried, and organized. This can be one of the complicated aspects of communication since people tend to react to different "styles" instantaneously and fervently (*Cristerna, 2014*).

With the presenter allowing others to control the conversation with consent, passive communication style is being used. These passive individuals do not retort openly to spiteful situations and just agree to whatever to avoid confrontations (*Cristerna, 2014*). With the presenter being intimidating or calculating, aggressive communication style is being used.

It embroils manipulation at all times. Individuals like these are skilled at influencing or controlling others to their own advantage. Exercising dominance in every word and tone. (Ryan, 2014). With the presenter appearing passive on the surface but is really acting out antagonism in a subtle, indirect way, passive-aggressive communication style is being used. Their spoken words hide an underlying message, of which the other person may be totally unaware. Manipulate by using dishonest messages (Cristerna, 2014). With the presenter having the confidence and clearly stating what needs to be said without resorting to games and manipulation, assertive communication style is being used. It is the sweet spot between being too aggressive and too passive (Ryan, 2014). As these network marketing businesses are growing today, many people are thrilled to know the secrets behind their success. Being the top network marketing companies in De LaSalle University- Dasmariñas, the researchers chose these three enterprises namely Unlimited Networks of Opportunities (UNO), Aim Global and Front Row to alleviate the knowledge on the communication styles they use. These are all direct selling companies and are targeting to persuade people to join them. Essentially, these three network marketing businesses are all established in the Philippines and are all Filipino-owned companies.

This study is significant, primarily because of its timing. This document should act as a hint into the perspective of the networkers and how they are able to convey their message towards their prospects using the communication styles. There are various communication styles but only the 4 basic communication styles were cited on this paper since those appear simpler, commonly used and highlight human relations more.

Literature Review

Elaboration Likelihood Model

The elaboration likelihood model (ELM) views persuasion primarily as the targets of persuasive messages use mental processes of motivation and reasoning to accept or reject persuasive messages. Developed by Petty and Cacioppo (1986), ELM posits two possible routes or methods of influence: centrally routed messages and peripherally routed messages. The more complex of the two paths is known as the central route, also referred to as an elaborated route. Centrally routed messages include a wealth of information, rational arguments, and evidence to support a particular conclusion. Centrally routed messages are much more likely to create long-term change for the recipient than are peripheral messages, however, not all individuals are capable of receiving centrally routed messages. As a result, when motivation or ability is missing from the target audience, the persuader can use the peripheral route to persuasion. Peripheral messages rely on a receiver's emotional involvement and persuade through more superficial means. Thus, ELM predicts that when the audience is unmotivated or unable to process an elaborated message, persuaders should focus on quick and easy ways to produce change. One significant drawback is that the peripheral route leads only to short-term change, if any change at all. ELM emphasizes the importance of understanding audience members before creating a persuasive message (Petty and Cacioppo, 1986).

The Narrative Paradigm of Walter Fisher (Griffin, 2012) argues that humans are story tellers. He is convinced that we are narrative beings who experience and comprehend life as a series of ongoing narratives, as conflicts, characters, beginnings, middles, and ends and it invites listeners to interpret its meaning and assess its value for their own lives. He proposed that offering good reasons has more to do with telling a compelling story than it does with piling up evidence or constructing a tight argument. According to Fisher, the secular combination of pure logic on one hand and emotional stories stir up passions on the other.

Narrative rationality is determined by the coherence and fidelity of our stories as the world is a set of stories from which we choose, and thus constantly re-create, our lives.

Rhetoric Theory by Aristotle saw the function of rhetoric as the discovery in each case of the available means of persuasion. Rhetoric is defined as the ability to see what is possibly persuasive in every given case. This is not to say that the rhetorician will be able to convince under all circumstances rather he is in a situation similar to that of the physician: the latter has a complete grasp of his art only if he neglects nothing that might heal his patient, though he is not able to heal every patient. Similarly, the rhetorician has a complete grasp of his method, if he discovers the available means of persuasion, though he is not able to convince everybody. (*Rapp, Christof, 2010*). Aristotle's view an orator will be even more successful when he just picks up the convincing aspects of a given issue, thereby using commonly-held opinions as premises. Since people have a natural disposition for the true and every man has some contribution to make to the truth there is no unbridgeable gap between the commonly-held opinions and what is true. This alleged affinity between the true and the persuasive justifies Aristotle's project of a rhetoric that essentially relies on the persuasiveness of pertinent argumentation.

Application to Communication Styles and Persuasion Strategies of Networkers

Persuasion leads to convincing people about a certain matter. Persuasion attempts to make a person become in a manner of embracing a viewpoint or a mindset that concerns such tradition, beliefs, attitudes and behaviors. Elaborate likelihood model has its advantage in the essence of networking business, the nature of persuasion is bombarded through the content of the messages being delivered. The power of words depends on how the speaker says the message. The said theory also contributes in the position of advertising in a way of endorsing products through the word of mouth and aims to encourage the consumers to buy. Through this, there will be a cash sustaining value and could possibly attract more consumers and create another negotiations.

In the Narrative Paradigm of Walter Fisher, the network marketing business is evident on how the networkers encourage their prospects to join and tell them the success of their own stories or their higher ups. Another significant factor is the stories being shared by those who have been successful in business. The testimonials of those networkers to the prospects during business meetings, sends message to the prospects that they themselves can be successful. Through the testimonies by the networkers, their prospects become more engage, so that they will be able to achieve what the top earners or the successful ones did.

The Rhetoric by Aristotle is relevant on how the networkers apply reason to imagination for the better moving of their free will. With the networker's type of persuasion, they will first use the artistic proof to highlight the chance of success then afterwards use the inartistic proof to emphasize the huge possibility. The five canons of rhetoric are highly relevant to the networker's use of persuasion to make reasonable point about joining the company. Capturing the attention and establishing the networkers credibility using different communication styles to tell their prospects how serious they are in working with them to have a successful future. Naturalness and having a full blown knowledge is one's key to motivation.

Research Design and Methods

In this study, qualitative method will be used to investigate the networking companies within De LaSalle University-Dasmariñas specifically UNO, Front Row and Aim Global. The researchers have observed and participated in the process being done by different networkers when they are trying to convince one person into joining their company. The data gathering was divided into two sections such as in-depth interview as it is useful when

detailed information about a person's thoughts and behaviors is needed and executed observation and interaction with the participants throughout the research process. The tool that was used for data gathering is documentation particularly, audio recording. The researchers analyzed the data by the transcribed audio material from the individual interviews and observations will be recorded either through an audio documentation or an observation checklist.

Population

The researchers prepared a set of interview questions for the in-depth interview and another set of open-ended questions for the semi-structured interview. The participants consists of students and alumni of De LaSalle University- Dasmariñas who were Adrian Feliciano, AJ Adan and R-jin Sarmiento from UNO, Kat Olino, Vincent Tio and Fatmah Keita from Frontrow, and Baldwin Caballero, KM Villanueva and Micko Joson from Aim Global.

Findings and Discussion

Communication Styles used by Networkers

The nine networkers have answered passive-aggressive as their top characteristic when it comes to recruiting and second is aggressive, and third is assertive. From the company, Aim Global, they have said that being passive-aggressive is always a part of their recruitment process and they call it framing which is about showing their good, friendly and warm side to easily build relationship. They also see their selves as playful because they do not want to be hindered by awkwardness and they see this as an easy way to convince their prospects. They also said that comfortability is also another factor they want to highlight whenever they recruit people since in business, there is money involved and with that they need to build the trust, make their prospect at ease with them and must always portray calmness. With the company, FrontRow, they have said that being passive-aggressive is a part of any business transactions since there will always be this path that they need their prospects to go or lean to and it will always be a part of their plan to motivate people to join their company. In line with that, they mostly use word play, their cleverness in communication to attract their prospect and lean towards the path they wanted in the first place. They sometimes use humor to bait their prospects in and then grab the opportunity to discuss their business. The description of their selves varies from one adjective to the other but they all agree with making their prospect realize that they can be family and that they can be trusted. From the company UNO, they believe being scheming will help their prospects realize that they can be a lot of help to a person who dreams big and joining their company is the first action that person needs to undergone to fulfill the dreams. They are already beginning to create a mindset that they will use until the end of their recruitment process. With UNO, excitement leads them to radiate confidence while having fun, they need to look enjoyable with what they are trying to sell, which is their company to their prospects.

Talking to their prospects seemed to be easy for them because of the characteristics they portray. They claim that naturalness attracts their prospects to feel like they are already close as well as the familiarity even though they just met for the first time. They mostly build their prospect's curiosity to be highly encouraged with what their business is all about. They call it anchoring, which is to feel connected and relatable to their prospects. They open topic about their prospect's lives to assess what could be the best way to approach them. They want to empathize and understand their prospects better. They are just maximizing what their prospects could get when they join their company by relating the experiences that they now hold based on their observation and understanding of the prospect's characteristics and knowing what factors they could use to persuade their prospects into joining.

They said that even though they agree with jokes as a technique, they also use aggressive style as it is the most formal way of inviting prospects and sharing their proposition, as well as, they could get the feeling of authority and respect which they need to earn for the prospects to feel that they are genuine and they tell the truth. They feel that they must not fail to deliver the results that the prospects need to see in order for them to be encouraged. With high regard with respect, they are being dominant to earn that respect in return. Building their credibility is quite difficult since most of them are getting negative feedbacks. Still, they know how to handle these objections by taking time to explain to their prospects what they deemed the prospects need to know. They usually show evidence of their company's legalities and evidence that they are really earning lots of money. They let their prospects say everything they thought they knew about the company because these networkers are certain that after those bursts, their prospects will be all ears of what they have to say. Sometimes, some prospects are still difficult to persuade. In these kinds of times, they use their prospect's words against them to make them realize that there is more about their business than they knew. They claim that it is not to create a conflict but to let them see the positive side of their proposition. They also use reverse psychology to have their offer more appealing and comparison to highlight their proposition.

These networkers claim that even though they are passive-aggressive and aggressive, they can still be assertive by being confident and clearly stating what needs to be said. There is still a truth from it by discussing what their business and products are all about. They said that they are already confident in what they are doing because they have been in the business for far too long, they have already earned a lot and they have already helped numerous people. They furthered that confidence must always be shown when they are recruiting because some people use this as a basis for deciphering the truth from the lie. All of them said that they are just sharing the opportunity so they are not hiding anything from the prospects and just wants them, their prospects, to understand what their business is all about. They claim being straightforward. When they do meet-ups, they tell immediately that they will be talking about a business which is networking. Consistency for them is one of the factors the prospects want to see when they are explaining their products and compensation.

The Way the Networkers Use the Communication Styles

With how the networkers use the communication styles when recruiting prospects, they mostly dominate the conversation or being aggressive and do sweet talks or being passive-aggressive. Based on their answers and the researchers' observation, these two are interconnected but also interchangeable depending on the situation they are in.

They dominate the conversation to attract authoritative and respect since they are the ones who know everything about the business and the products. They shape the environment by overcoming opposition to accomplish results. The reliability and dependability must ooze from their personality to show their mastery in the network. They want their prospects to see them as knowledgeable and already an expert with the business they are offering as well as they must phrase their sentences according to what can affect most their prospect's minds. Also, they said that some prospects need to see their determination in recruiting them and their capability to do so. They do not want to be hindered by any external factors when recruiting, though they think some would have an impact, still, they do not want to limit themselves. For them, their business is for everyone who wants to earn money; and when people see an opportunity to have money, they will immediately grab it. They just think that with every factor, they are things that they need to consider. Based on the researchers' observation, they mostly ask questions that are answerable only by yes and/or favorable to their proposition to send a sense of leverage among the prospects that they are right.

They sweet talk the prospects without them hinting because this is a part of their technique which is already incorporated in every word and sentences they use. As the way passive-aggressive communicators deliver their sentiments, they usually talk with sugary sweet voices and touch others as pretends to be warm and friendly. Since mostly, they are entering that hostile part of people's mind about networking, they do sweet talk to change their views about things and to open their minds about the business that they are offering. Additional with their sweet talks is the materials that they are using as evidence to bridge the gap either between them and their prospects or the successful persons and their prospects.

They mostly show pictures of successful persons because they want to create an image that their prospects will also have the same fate as their higher ups if they join the company. They also call this bridging, which is leading their prospects to think that they could also prosper in the business. Moreover, they use the pictures of activities which they mostly post on their social media accounts to touch the curiosity of their prospects. They said that a legitimate networking company has products to offer so they also show the product testimonials to their prospect to make way for the possibility of them joining the company. Moreover, the materials will be based on the needs and wants of the prospects, according to the networkers.

These networkers also have their difficult times convincing their prospects to join and they are all fond of saying, "we don't please people," but their explanations seems in contrast with it. When asked further, they created different strategies to satisfy their desire to share the opportunity. With this, they will do instant rapport to build the trust and the relationship they desire as future business partners, as they say. Making the person curious and making them realize their needs and wants are some of the best tactics they use. Another is they let their uplines do the talking and explaining of the business more.

The Way the Networkers Persuade the Prospects

Goal setting is their most effective tactic when it comes to persuading their prospect since they claim that it must be automatically done in any business. To make them relatable to their prospects, they share experiences connected to their prospect's interest. They will tell their own stories which are always from rags to riches, as they say. They will share their own visualization of what they want to have and want to be. Since the foundation of their relationship is trust, comfortability and familiarity, they chose safe topics as their second most effective way because they asserted that this is a people's business so the right handling and good attitude towards their prospect are the things they value. The approach must always be humanized as well show emotion in analyzation and knowing the interest of their prospects are the two challenges they need to fulfill to persuade them to join. Last but not the least is the show off. Not to boast but show proof that they are earning money with their business. They claim that this is one of most concrete way to encourage their prospects to have a taste of their business.

With the methods they use to influence the prospects to join, they mostly responded with building trust and friendship, making the stories relatable to their prospect by focusing on the interest, goals and motivational factors the prospects have while baiting themselves. The networkers persuade their prospects using the strategies of reverse psychology, comparing actions or comparison, refutation, self-actualization and arousing emotions. With reverse psychology, they often use this when prospects are hard to persuade and they think that there is a 50 percent chance that they will be able to sway the prospect's point of view. With comparative-advantages pattern, most of the time, they give their prospects a scenario which the solutions is what they want the prospects to do. A participant compared a 6k worth of shoes or a 6k worth if investment. The participant explained that if it will be shoes then no money will ever come back but if the prospect invest it to their company, he could even get

12k in return. With refutation, they use this for prospects that are in the worst case scenario to make them realize that these networkers are the experts. They have this term called “basag” which makes their prospects contemplate with what they have said because the gravity of the question returned to them is hefty. With self-actualization, they portray and believe that they are someone with good heart and so this is reflected by how their prospects see them. With arousing the emotion, they plead to their prospects’ ego. The background of the prospect is already established from the beginning so they will use this as the prospects’ weakness to sway his or her thoughts.

Conclusion

The main purpose of this study was to know the top 3 communication styles that the networkers use, their ways of using it and their methods in persuasion. The researchers conclude the study and acquired the following results: The top communication style used by networkers is passive-aggressive style as they claim that this style is a must for any businesses as they are always scheming and they always sweet talk their prospects into joining the company. The second is the aggressive style because they see it as the most formal way to invite a prospect as they want to get the feeling of authority and respect, thus, to be seen as knowledgeable. The third is the assertive style because they claim that they are confident in stating what needs to be said and they tell immediately that their proposed business is networking. With how these networkers use these communication styles, they use passive-aggressive style and aggressive style. These two styles are interrelated and interchangeable depending on the situation. With their methods of persuasion, they use reverse psychology, comparing actions or comparison, refutation, self-actualization and arousal of emotions.

Limitations

A study of networking can result in one joining the company and being more efficient and effective in the said field. However, the researchers put more emphasis on the aspects of communication present in the three specific networking companies namely UNO Front Row and Aim Global.

It was not within the scope of this paper to give an in-depth analysis of all the aspects of communication strategies. It was limited only to verbal communication styles and persuasion strategies of these networkers. The study pointed out that there may be other factors besides the communication styles used by the networkers that may affect the interpretation and adoption of prospects.

In addition to that, the researchers were open and willing to adjust whenever there are new and additional information during the span of the study to a limited extent only. The researchers’ major concern will usually be in the variety of communication styles found in the gathered data. When researchers reported their findings, some raw data (e.g. direct quotations from participants) as well as analyses of the data based on what was gathered were included.

Implications

The study aims to discover the communication styles of the networkers in the Universities in Dasmariñas, Cavite which would be useful for persons who are interested in joining the network marketing or multi-level marketing. These include not only employees, professionals, and businessmen who want to have a part-time job to earn extra income but also students.

The study is beneficial for aspiring leaders and those who would want to establish their own business. Networkers are not only persuaders but are also good leaders especially

*The Communication Styles Used by Networkers from UNO, Front Row and
Aim Global within De La Salle University- Dasmariñas*

in handling the activities of their recruits. The researchers aim to prove that everyone may adopt this kind of leadership in different facets.

This paper is also beneficial to future researchers who wish to generate and prove further study, emphasis and justification on matters which the researchers were not able to do due to the given time frame and other limitations.

This study is also beneficial to students and professor as they will have an additional knowledge as to how to communicate effectively with each other. This can also be useful for the professors to motivate their students to join various school activities, to come regularly in class and to participate well in class. With regards to dealing with people and conflict, those are already part of people's lives though this study will also be helpful as to knowing the communication style needed to be used when dealing with other people or preventing conflicts.

References

- Cristerna, J. (2014). The Four Basic Communication Styles. Web log post. LinkedIn Web, n.d Web.7 Mar. 2015
- Go, E., & Go, N. (2011). Marketing Breakthrough from Trials and Triumphs. Mansmith and Fielders, Inc., New Manila, Quezon City, Philippines pp. 31-32
- Griffin, E. M. (2011). A First Look at Communication Theory 8th Edition. New York: McGraw Hill.
- Grose, R. (2010). The Sunday Times: How to Sell Yourself, New Edition. Kogan Page Ltd Publishers, Philadelphia, Pennsylvania
- Mcquail, D. (1994). Mass Communication Theory: An Introduction, 3rd Edition. Sage Publications, London EC24 4PU p. 56
- Newton, C. (2015). The Five Communication Styles. Web log post. Brilliant Web, n.d Web.7
- Petty, R. E., & Cacioppo, J. T. (1986). The Elaboration Likelihood Model of Persuasion. *Advances in Experimental Social Psychology*, 19. Cambridge: Cambridge Academic Press.
- Rapp, C. (2010). Aristotle's Rhetoric. *The Stanford Encyclopedia of Philosophy*. Edward N. Zalta (ed.), Retrieved March 13, 2015 from <http://plato.stanford.edu/archives/spr2010/entries/aristotle-rhetoric/>
- Ross, R. C. (1995). *Speech Communication: The Speechmaking Process*. (10th Ed.). Simon and Schuster Company. Needham Heights: Massachusetts.
- Ryan, C. (2014). Basic Communication Styles. Web log post. LinkedIn Web, n.d Web.7 Mar. 2015
- Templeton, T. & Blanchard F. (2005). *The Referral of a Lifetime. The Networking System that Produces Bottom- line Results... Everyday!* San Francisco: Berrett-Koehler Publishers.
- Villamazo, P. C., Neus, J. G., & Cruz, E. E. (2000). *Functional Oral Communication*. Manila: University of Santo Tomas Publishing House.
- Whalen, D. J. (1996). *I See What You Mean: Persuasive Business Communication*. Thousand Oaks: Sage Publications.
- Xardel, D. (1993). *The Direct Selling Revolution. Understanding the Growth of the Amway Corporation*. Blackwell Publishing.

Teaching Foreign Languages in Former Soviet Space - 21st Century Georgian Practice

Ana Bakanidze

Sokhumi State University
Faculty of Humanities
Tbilisi, Georgia

Abstract

This presentation aims to present research on new approaches, methodology, challenges and achievements of teaching foreign languages in post-Soviet Union space in the period of the 21st century. The opening part will present issues related to teaching foreign languages in Soviet Union space and the core topics for discussion are key issues related to teaching in general in what are now former Soviet countries and more specifically in 21st century Georgia. Research will be concluded with discussion on the following: Russian language was dominant in Soviet times and the process of teaching foreign languages was in fact regulated by the centralized government; handbooks were unified and loaded with Soviet ideology; the population had low motivation for studying and utilizing foreign languages. In the former Soviet Union space and especially in the 21st century, motivation for studying foreign languages has increased; adapted handbooks for teaching foreign languages are based on American and European practices; effective methodology of teaching approved in many countries became widely spread in Georgia; school- and university-level education in Georgia still requires amendments to the methodology. However, it's worth mentioning that the practice of private tutorship has been developing in the country recently; dominance in terms of frequency of teaching and studying is English (which has in fact become a sort of second language for the young generation), followed by Russian, German, French, Italian, Turkish, Greek and others. The Republic of Georgia in the 21st century has a demonstrated rapid growth of demand in studying foreign languages which also causes improvement of criteria for the educational system.

Keywords: Teaching Foreign Languages, Former Soviet Space, Georgia

Introduction

Before we move on to discussing the trends and contemporary situation, one shall brief on the history of teaching foreign languages in Georgia. Georgia is a country with a diverse and rich history. It is located in the South Caucasus region and has its own language, which is part of the Ibero-Caucasian language group. In general, this group is very interesting and diverse in terms of linguistics; it has quite difficult grammar categories and rich phonetics. For example, the Caucasian accent creates consonants which are in every Caucasian language and are hard to pronounce for people who are not speakers of these respective languages.

Georgian is the only language from this group which has its own alphabet. This alphabet has been changing through centuries and at this stage we have all three types of Georgian alphabet. These are Asomtavruli, Nuskhuri, and Mkhedruli.

The very first literature work (Martyrdom of Shushanik) goes back to the 5th century. However, introduction to this work informs that some facts are used from literature works produced before that unfortunately are unavailable now.

Besides centuries of writing history of Georgia, language and instruction of languages had a very big importance in Georgia; for example, literature work ("The Vita of Grigol Khandzteli", year 951) going back to the 10th century, demonstrates that religious leaders spoke a number of languages. Historical documents also inform us that Georgian kings and nobility also knew foreign languages.

Throughout centuries, knowledge of foreign languages was a sign of being an educated person; however, times changed and priorities were also differing; for example, during the 12th century, Greek language was the priority, during middle ages, it was Persian, and in the 18th and 19th centuries, Russian and French languages took the lead.

During the 20th century, English and German languages slowly entered the educational and public arena; however, during these times, Russian remained as the most important foreign language. Soviet officials did their best to portray Russian not as a foreign language but a native one for the Soviet citizens. It's worth mentioning that for Georgians, Russian always remained and still is a foreign language.

Background

Teaching Foreign Languages in Soviet Georgia

"In the period of 1921-1990, the education system of Georgia was purely dependent on those decisions and directions that were provided by respective officials from Moscow to their Georgian counterparts. The reasoning for that were educational programs, plans and the vast majority of school books that were centralized and then adapted, "translated" to respective local languages of member republics. Teaching foreign languages in most of the cases was pre-defined and pre-planned by the central authority. The central committee of the Soviet party adopted a decree in 1933 setting forth that a decision on creating unified "stable" schoolbooks which, by its nature, would ensure that a unified and joint study process would be carried out throughout the Soviet Union. For instance, from the year of 1940, those English and German language schoolbooks that were printed in Tbilisi would be a reflection of those versions that were developed in Moscow, on a central level." (Mindandze, 2006, pp 38-41).

In those respective times, schoolbooks would be developed with an influence of translation-grammar methodology and, thus, would pay a significant amount of time to teaching issues related to grammar aspects along with translation. We shall also mention that the

educational system used during the Soviet times would be perceived in most of the cases primarily as a source for ideological upbringing of the younger generation; the latter aimed at upbringing of a “Soviet Citizen,” the best portrayal of pressure from this ideology could be identified among study topics.

That is why foreign language handbooks would have specific content such as agriculture and economics and would also portray the life of pioneers, Soviet Union activists, and soviet heroes, as well as text reflecting soviet states’ lives. Such content indeed had an impact on beneficiaries. In the course of the Soviet Union, issues along with methodology of foreign language instruction require further and comprehensive study; however, in frames of general study, one could assert that, besides absence of relevant theoretical principles and not limited to obvious reasons for teaching language – neither schools, nor higher academic institutions in the Soviet Union could carry its obligations in the way it was supposed to; there could be few reasons identified in this regard:

Centralized study programs and plans; lessons that were more in compliance with the Soviet aspirations; grammar and vocabulary has a dominant role in study programs; paying less attention to speaking skills; these study programs would absolutely ignore listening skills; low motivation of students which was caused by those texts and vocabulary full of pre-defined ideology and texts and etc. (Mindadze, 2006).

Beyond all of these processes, it’s worth mentioning that the Soviet educational policy served as a tool for positioning Russian as a native language for the Soviet citizens. Casework was carried out in the Russian language and so was TV and media in general. Russian was a common language for communication and various efforts were made to weaken national languages. A clear demonstration of this argument is the 70s of the previous century, when there was an attempt to change the constitution, including in Georgia. In 1978, based on the new version of the constitution, the Georgian language was doomed to become abolished as a state language – this also meant that secondary and higher education in Georgia would have been Russian, thus Georgian would be harmed.

Students in Georgia went against this idea and there were some very large protest actions organized, which was also the largest one in the history of Georgia and also the one that didn’t result in people being killed. Basically, the Georgian language’s status was kept as a national one in the constitution; a special monument was also placed in Georgia and special day was also marked in the calendar; we still celebrate this day as an official state celebration. Back then, Georgian students really demonstrated their power to the huge Empire, which in fact entered Afghanistan very soon with forces; it also threatened Poland with just another intrusion. If we discuss more, in 1978, protest actions turned into national movement and it resulted in regaining independence in 1989.

Therefore, teaching the Russian language was a priority in Soviet Georgia; there were other manuals and handbooks in the Soviet Union and the same ones were used in every member country. Books were full of Soviet ideology and usage of these languages was limited because of closed spaces and borders. Because of this factor, teaching foreign languages was not a priority. The teaching process mostly covered translation and grammar manners.

Methods of Research

Foreign languages in Contemporary Georgia

The situation in contemporary Georgia is relatively different: after Georgia became independent, Russian language and literature received fewer classroom hours. However, Russian still remained as a leading foreign language which was taught to school pupils. Russian still kept its privilege since its literature was also taught along with a language, because this was not the case with English, German, French and other languages.

Such reality existed in the 1990s and one can assert that such development is partially a result of the Soviet path or incumbent government's foreign or internal priorities. The core aspect for announcing Russian and the compulsory foreign language was the fact that after the collapse of the Soviet Union – Georgia became part of the Union of Independent States. It shall be noted that Russian was taught from third grade only at specialized schools, where other languages such as German, English and French were also taught in a comprehensive manner and from second grade. All these foreign languages were still taught with old Soviet programs and guidebooks (Gusharashvili, 2014).

Major changes in the educational system started from the year of 2000. Based on the national action plan, instruction of foreign languages were very important. Changes to the methodology were mostly related to improving communication skills.

According to the decision of 2001, the Common European Framework of Reference for Languages became a valid system in regards to foreign languages.

The latter document really affected teaching-instructing languages not only in Europe, but also in the whole world.

From 2006, national study plans were supposed to be in line with the Common European Framework of Reference for Languages and with standards it has set. It also sets which level of instruction it has to be in compliance with basic, beginner and intermediate language levels. (Sikharulidze, 2012).

Georgia, which is the member state of the Council of Europe, demonstrates a high percentage of foreign language fluency, therefore the educational plan in the schools of Georgia sets knowledge as few (two-three) foreign languages as a priority of the European framework.

In 2005, foreign language became an option in Georgia; from 2010, the first foreign language was English. Pupils are able to select a foreign language from the 7th grade that is also in compliance with an option of selectiveness.

There are few resources of teaching languages, such as public schools and universities; also, private tutors and international language study centers are becoming increasingly popular. However, private tutors are indeed the most popular.

Due to the fact that the University education has the long-lasting history and wide resources, we are going to present more widely.

Instruction of Foreign Languages at Universities

What is the history of instruction of foreign languages at higher education institutes of Georgia? The first higher education institute, Ivane Javakhishvili Tbilisi State University, was established in 1918 in Georgia. The latter higher education institute has the biggest experience of the instruction of languages. Through the years, the most famous scientists and specialists instructed Georgian languages (Arnold Chiqobava, Simon Kaukhchishvili, Giorgi Tsereteli and the others). Initially, the directions of Iberian-Caucasian languages, classical philology and Oriental studies was established. Instruction of English, German, French and Russian has a

history of decades. Currently Tbilisi State University represents the biggest resource in terms of the instruction of foreign languages among Georgian higher education institutes, particularly the following directions are functioning at the Humanities Faculty of University: Caucasian Studies, Orientalology, Classical Philology, Byzantine Studies, Modern Greek Studies, Western European Languages and Literature, Slavic, American Studies, Instruction–Scientific Institute of Scandinavian Studies, Japanese Language and Culture Centre, Centre of Polish Studies, Centre of Jewish Studies, Centre of the Ukrainian Studies, and Centre of Turkish Culture. Instruction is being conducted on three levels (Bachelor, Master, and Doctoral - BA, MA, PhD at the majority of the mentioned centers. English Philology is in the highest demand (popular) in terms of the number of students; it's followed by German, French, Italian, and Greek philologies. One of the lowest demands is on the instruction of Caucasian languages.

In the period of the Soviet Union, special attention was paid to instruction of the Russian language. Therefore, we see the department of Russian philology not only at the Tbilisi State University. For instance, the history of Russian studies of Batumi Shota Rustaveli State University counts more than seven decades. Instruction of the Russian language commenced from the period of the foundation of Batumi Institute in 1935. In 1938, the department of Russian language was established; it was reorganized several times through the years, it was functioning together with the department of Russian literature or independently.

In the period of the Soviet Union, Russian was considered to be a basic or second language in all spheres in Georgia. The same situation was at higher education institutes, there existed not only directions of Russian philology, but also Russian sections of almost all specialties, the same approach prevailed at secondary schools – separately Georgian and Russian schools. Children and young people with Georgian nationality studied at these schools and institutes. In the 1950-60s studying in the Russian sector was regarded as prestigious and was very popular. Later on, from the 1970s, when the national movement started to become active, the popularity of the Russian language lost its strength gradually, especially after 1978 when the authority of that time revealed its intention to cancel the status of the state language of Georgia from the Soviet Constitution of Georgia. Then huge protests of Georgian students, which were very dangerous and rare in the conditions of the Soviet regime, prevented the realization of the latter initiative. These events increased a desire to protect the Georgian language, especially among Georgian young people. Considerable parts of our respondents involved in the research indicate that a big contingent of pupils who studied in Russian sectors at schools shifted in the Georgian sector that time.

German, English and French languages approximately with the same load were instructed at schools and higher education institutes during the Soviet regime. A majority of the respondents of our survey consider that the German language was the most popular after the Russian language in the conditions of the Soviet regime in Georgia and most of the people studied this language as a foreign language at schools and higher education institutes.

What are the conditions currently in terms of instruction of foreign languages at higher education institutes? Nowadays, 31 authorized universities (higher education institutes which implement three levels of higher education programs and scientific researches) are functioning in the country according to the official data of the Ministry of Education and Science of Georgia. We studied the educational programs of the mentioned universities and their resources in terms of instruction of foreign languages.

In the 2015-2016 academic years, 15 higher education institutes from the acting authorized 31 state and private universities have special instruction programs of foreign

languages. Most of the universities where instruction-scientific institutes or departments of foreign languages don't exist have specialized profiles, such as Tbilisi State Medical University, Shota Rustaveli Theatre and Film University, Tbilisi Vano Sarajishvili State Conservatory, Agricultural University of Georgia, Apolon Kutateladze Tbilisi State Arts Academy, Georgian Technical University, Georgian Aviation University and etc.

The universities where instruction of foreign languages is conducted:

100 % - section of English philology;

40 % - direction of German philology;

40 % - direction of Russian (or Slavic) philology;

33 % - direction of French philology;

26 % - direction of Oriental languages (Arabic, Persian, Turkish);

20 % - direction of Turkish philology.

It should be noted that Turkish is often joined with the direction of the instruction of Oriental Languages, In such case if we combine directions of Turkish Philology and Oriental languages where Turkish is instructed thoroughly as a foreign language - then the share of the instruction of Turkish at higher education institutions of Georgia reaches 40%;

20% offer Greek studies (*NeoGreek*);

13% - Italian Philology.

It should be noted with regards to the instruction of Caucasian languages, the Georgian language is representative of the respective linguistic family; Georgia is the part of the South Caucasus. Abkhazian language is one of the Caucasian languages; Abkhazian is the second state language after Georgian according to the Constitution of Georgia. Unfortunately, the share of instruction or studying of these languages is close to minimum at higher educational institutions in Georgia.

Less than 10% of universities instruct the other foreign languages. The following programs exist.

Prioritized foreign languages:

Research of educational programs of universities would have been enough in order to determine which is the most important foreign language in Georgia today, most of the higher education institutions have a program of English Philology; English takes the first place according to the number of students studying in Bachelor, Master and Doctoral programs of foreign languages.

It is possible to determine the priority languages by means of assessment of the statistics of Unified National Exams of Georgia except the university environment. The exams have been held in Georgia since 2005 and it's permitted to enter accredited higher education institute only after passing the mentioned Unified National Exams.

LEPL NAEC- National Assessment and Examination Center of the Ministry of Education and Science of Georgia manages the process of Unified National Exams.

Below is given the chart of the statistics data showing the changing number of registered junior high school students from year to year at the entrance exam of foreign language.

Unified National Exams - 2005-2015				
Year	Number of registered junior high school students			
	English	German	French	Russian
2005	16560	5266	1426	6805
2006	18226	4842	1221	7610
2007	23290	5246	1212	8702
2008	14820	2078	488	5729
2009	17001	3439	917	6561
2010	21926	3340	859	7354
2011	21854	2723	697	6504
2012	23746	2641	664	5438
2013	28979	2333	447	7525
2014	25269	1539	312	6455
2015	29117	1422	266	7413

Data is authorized by LEPL NAEC- National Assessment and Examination Center.

Another survey, which was conducted in order to determine a priority foreign language in Georgia, was related to open employment vacancies. We studied available vacancies on the largest employment websites of Georgia: www.jobs.ge and www.hr.gov.ge. We divided them into 3 main categories: vacancies in the state / public sector, jobs, vacancies in private sector and vacancies in international organizations and non-governmental sectors. We surveyed vacant positions separately for managers and lower-level officials in each of the above mentioned sectors. Results are as follows:

In the private sector (average summed data are presented only):

English language knowledge is mandatory according to the qualification requirements of 80% of vacancies;

40% is mandatory to have knowledge of two foreign languages: English and Russian;

10% is mandatory to know the Russian language only.

In the state/public sector (average summed data are presented only);

English language knowledge is mandatory according to the qualification requirements of 50% of vacancies;

50% is mandatory to have knowledge of two foreign languages: English and Russian;

10% is preferable to have knowledge of any other foreign languages (German, French, etc.)

International organizations and non-governmental sectors (average summed data are presented only);

Knowledge of English language is mandatory according to the qualification requirements of 90% of vacancies;

30% is mandatory to have knowledge of two foreign languages: English and Russian;

10% is mandatory to have knowledge of any other foreign languages (German, French, etc.)

Findings and Conclusions

Our survey enables us to come up with the following conclusions:

The greatest resource and experience of instruction of foreign languages exist at the Ivane Javakhishvili Tbilisi State University;

The greatest share of instruction of foreign languages comes from the state universities; however, there are private universities, where diverse resources of language instruction exist, for example, at the program of Bachelor's degree of International Relations at Free University. Arabic, Persian, Chinese, Japanese, Korean, Turkish, French, Spanish and German languages are instructed at the Institute of Asia and Africa;

The program of English philology can be found at all universities where foreign languages are instructed; only the English language program is instructed in some universities;

The English philology program still remains the most popular and in high demand at universities where only English philology is available and at universities where other languages are accessible too, the next positions are occupied by the German, Slavic, French, Oriental, Greek and other languages;

Foreign languages are instructed mainly at the Faculty of Humanities;

Based on statistics in regards to entry exams at the higher academic institutions:

English represents the foreign language which is in the highest demand and priority in Georgia;

The biggest portion of high school juniors choose English as a foreign language while passing university entry exams;

Demand on English language is growing annually, while demand on other European languages (French and German) is reduced;

Russian is the second language being in high demand after English. Popularity of the latter languages neither increased nor decreased, according to the number of registered high school juniors respectively; demand on Russian is stably medium after the English language.

Based on the obtained data that is in accordance with opening vacancies with employment opportunities, one can assert that, English language is a priority for all sectors of the employment market, and the next is the Russian language. Knowledge of foreign languages is in higher demand in International organizations and the private sector. Knowledge of foreign language is mostly demanded on managerial positions.

References

- Abdushelishvili, L. (2013). Developing verbal fluency among adults through teaching process; Tbilisi State University publishing;
- Anderson, R. C., Hiebert, E. H., Scott, J. A., & Wilkinson, I. (1985). *Becoming a Nation of Readers: The Report of the Commission on Reading*, National Academy of Education
- Baratashvili, I. (2014). *Effectiveness of an integrated combination of Phoenix-Graphoex methods while teaching English on a beginner level, as a foreign language*. Tbilisi State University Publishing.
- Mindandze, I. (2006). *Communicative didactics and discussion, as a source for teaching*. (pp 38-41). Tbilisi;
- Gusharashvili, G. (2014, May 23). Language Policy in Georgia. *Tabula*. 1-2.
- Sikharulidze, M., (2012). Competences for teaching foreign languages. *Mastsavlebeli*. 1-2.
- Tserodze, A. (2011). *Role of working through project in regard to teaching foreign language at the third level of school*. Tbilisi State University publishing;
- .

The Leadership Qualities of University Librarians in Nigeria in the 21st Century

Dr. Mohammed Abubakar Bitagi¹ and Dr. Obaje Alfred Michael²

¹Federal University of Technology, University Library, Minna, Nigeria

²Federal University of Technology, University Library, Minna, Nigeria

Abstract

University Librarians are expected to exhibit leadership qualities that makes it possible for university libraries to support the achievement of the objectives of their parent institutions. This study was therefore, carried out to determine the leadership qualities of university librarians and attainment of the objectives of university libraries in the 21st century in Niger state, Nigeria. The conceptual view of leadership was explained. The primary objectives of universities and the role of their libraries in attaining these objectives were highlighted. It was observed that adequate information resources were not available while expected services were not fully provided by the libraries. The descriptive survey research method was used for the study. Questionnaire and interview were instruments used to gather required data. The population of the study was 81 professional and para-professional staff of the two institutions studied. However, only 76 questionnaires, representing 93.8% were returned and found usable. Data gathered was analysed using frequencies and percentages. The findings of the study showed that the universities studied have ever failed or granted partial accreditation of some courses due to inadequacies from the libraries while majority of the respondents, 54 (71.1%) agreed that inadequacies from the libraries could be attributed to lack of leadership qualities of the University Librarians. Consequently, it was suggested by all (100%) of the respondents that University Librarians should possess such leadership qualities as being committed, competent, confident and highly educated, among others. It was concluded that the failure of university libraries in meeting accreditation requirements is sine qua non to failing to meet the objectives for which they were established. It was recommended, among others that aspiring university librarians should possess personal qualities that could enhance their leadership capabilities of university libraries.

Keywords: Leadership Qualities, Universities, University Librarians, University Libraries.

Introduction

The 21st century academic librarianship emphasizes the demand for leadership capabilities that meet with the challenges facing academic environments in terms of attaining their core objectives of teaching, learning, research and others such as requirements for institutional and courses accreditation. That is to say there is need for change in the way and manner some academic libraries are administered by their librarians. Turnbull (2008) reiterate that change is the only constant in the lives of professionals and responding to the new demands of this century is the challenge that keeps them and their colleagues awake at night.

Many scholars in recent times have defined and provided conceptual views of leadership. In the view of Levine and Crom in Fatokun, Salaam and Ajegbomogun (2010), leadership is about listening to people, supporting, encouraging and involving them in the decision-making and problem-solving processing. Similarly, Popa (2012) define leadership as the art of motivating a group of people to act towards achieving a common goal. In that direction, the author cited Drucker as having observed that leadership is all about results. Irrespective of the way and manner leadership is defined, these authors are of the view that leadership in the 21st century has to do with showing and paving the way for attainment of desired, expected, prescribed and assigned objectives. Consequently, it could be argued that the extent to which organizational objectives, and in this perspective, the academic libraries could be achieved, depends largely on the personal qualities and effectiveness of the university or college librarian rather than adoption of any style of management. That is why it is appropriate to assume that the failure of the university librarian to provide good leadership is tantamount to the total failure of the library to perform its expected functions.

University libraries are those that are solely established by universities to support the attainment of their objectives. Universities are charged with the primary objectives of teaching, learning and research. Their libraries, towards that direction, are expected to provide supplementary information resources in all formats and services that could enhance the attainment of the objectives of their parent institutions. In addition to providing current, relevant and adequate information resources and services needed to support teaching, learning and research, university libraries in Nigeria are expected to provide resources that meet with the accreditation requirement of the various courses offered by each university. Accreditation is an exercise carried out every five years to determine the continuity of courses offered by universities based on the available human and material resources of each Department and that of the library by the National Universities Commission (N.U.C.) which is an umbrella organization that supervises the academic activities of Nigerian universities to avoid graduating half-baked professionals in the 21st century.

From the foregoing, the role of university libraries in attaining the objectives of their parent institutions cannot be overemphasized. This is because if the university library fails to meet with the accreditation requirements that are needed to back up the curricula activities of the courses, such courses will not be accredited by the N.U.C. The effect of this may lead to lack of full recognition or suspension of such course(s). Thus, university libraries in Nigeria, in the 21st century, should be headed by librarians who have adequate personal leadership qualities to manage all the staff and other resources to meet the goals expected of their libraries.

University librarians are political appointees and professional heads of their libraries. Their appointment is for a single five-year term. They are responsible to the vice chancellors in the day to day performance of their duties, the top most of which is to effectively administer the library and its resources in order to realize the objectives for which the library was established.

Statement of the Problem

The university libraries are established to provide supplementary information resources and services to enhance the teaching, learning and research activities of their parent institutions and also meet with the requirements for accreditation of the courses offered by the institutions. In order to meet with these objectives, these libraries, in Nigeria, are provided with funds from various sources such as the Internally Generated Revenue (I.G.R.) of their institutions, allocations by the Federal Government and Tertiary Education Trust Fund (TETFund), and donations from individuals and organizations to acquire information resources.

A preliminary investigation by these researchers revealed unavailability of adequate information resources while expected services were not fully provided by the libraries covered by this study. The question at hand, then is what is responsible for these problems? Could it be due to lack of leadership qualities of the university librarians to manage the resources of their libraries effectively? The answers to these questions constitute a gap in knowledge. These researchers therefore, decided to investigate the leadership qualities of the university librarians of the libraries covered by this study to determine their effectiveness. This has become imperative because no study seems to have been carried out on this.

Scope of the Study

This research was based on the Federal University of Technology, Minna and Ibrahim Badamasi Babangida University (IBBU), Lapai libraries. The leadership qualities of their university librarians in line with the expectations of the 21st century were examined to determine their effectiveness.

Objectives of the Study

This study was conducted to achieve the following specific objectives:

1. Determine if the universities covered by the study have at one time or the other failed or granted partial accreditation of certain courses as a result of inadequacies from the libraries.
2. Determine if the inadequacies of the libraries could be attributed to lack of leadership qualities of the University Librarians.
3. Examine the types of qualities that are expected of the university librarians to effectively manage the available resources to attain the objectives of their libraries in the 21st century.

Research Questions

This research was guided by the following questions:

1. Has your university at one time or the other failed or granted partial accreditation of certain courses as a result of inadequacies from the library?
2. Could the inadequacies of the libraries be attributed to lack of leadership qualities of the University Librarians?
3. What are the types of qualities expected of University Librarians to effectively manage the available resources to attain the objectives of their libraries in the 21st century?

Literature Review

Abioye (2014) cited Montgomery to have defined leadership as the capacity and will to rally men and women to a common purpose and the character which inspires confidence. From this definition, it could be deduced that leadership has to do with summing up of sufficient courage, commitment and intellectual capacity to organize and direct others in order to achieve desired objectives. It therefore, becomes pertinent that for university librarians to achieve the core and other objectives for which they were appointed in the 21st

century, they must show a lot of courage, commitment and will to organize their staff, who belong to various cadres, qualifications and experiences in such a way that the goals of the parent institutions are easily achieved. Consequently, therefore, the success of the library in performing to expectations in the provision of required current and relevant information resources and services could be linked to the effectiveness of the university librarian. Equally, the failure of the library could be blamed, to a great extent, on the leadership of the library.

It is however, to be noted that for a university librarian to succeed in the 21st century, he must possess certain qualities. These, according to Abioye (2014) include the followings:

1. Each leader must have vision(s) of the kind of future the organization (library) is aiming at and be able to carry others along.
2. Leaders should be able to harness resources towards achieving defined objectives.
3. Effectiveness in leadership should involve taking cognizance of feedback from followers or subordinates in order to ensure that visions as communicated are being followed and carried out progressively.

An effective university librarian need to have a combination of the above qualities in order to judiciously utilize all the resources such as finance, staff, and materials to meet the institution's objectives of teaching, learning and research etc.

Imoke (2014) observe that there are many opinions on what a leader should be and do, and different lists of core competences that leaders should possess in order to adequately fulfil such a role. The author however, argue that anyone who facilitate change toward some desired outcome is displaying leadership qualities. After all, Turnbull (2008) observe that leadership entails painting a vision of where you want to go, establishing priorities for getting there, building the right team, aligning the organization (library), and holding people accountable for results. These qualities of institutional librarians could be measured by comparing the achievements of one librarian and the other. That is to say that if the current librarian is more innovative by introducing new ideas and policies that lead to better attainment of institutional objectives, he could be judged to be a better leader.

One of the necessary qualities of a successful university librarian is the ability to forge a reliable and dependable interpersonal relationship between himself and the staff and among the staff themselves. Cebula, Craig, Eggers, Fajardo, Gray and Lantz (2012) corroborate this view when the authors, in a research which focused on how leaders mobilize others to create extra ordinary results, found out that the how-to of leadership- the strategies, tactics, skills and practices- are insignificant unless leaders understand the value of the social capital built by investing in relationships. The authors also cited Kouzes and Posner as having stated that followers want their leaders to be honest, forward looking, competent and inspiring. In a similar dimension, Bennis and Goldsmith in Cebula et al. (2012) identified the characteristics that constituents want from their leaders to include purpose, meaning, trust, action, and results.

Abubakar (2013) studied factors that motivate employees perform to expectations in universities and discovered that for efficient performance, the employer must manage or harmonise employee objectives and channel them to productive use through motivation. It could be observed however, that the harmonization and channelling of employee objectives to production use could only be achieved where the leadership of various sections or units of the organization is very effective by serving as an example for others to follow. That is, the attributes of leaders in any organization determines to a great extent the actual performance of staff or employees working under them. Consequently, if the leader lacks sense of direction and under rate the role of motivation in achieving desired goals, the followers will follow suit, leading to wastages of all resources put in place by the organization. In Library

practices, this situation may lead to failure of providing necessary information resources and services that best meet with the information needs of the academic community, failure of students at examinations and non-conformance with the requirements of accreditation.

In contributing to the various ways through which a university librarian could motivate the staff to achieve desired goals, Ogunrombi and Elogie (2009) observe that unless conducive working conditions are developed that will motivate library employees to attain their maximum potentials, the attainment of the goals for which the university was established will be a mirage. The authors went further to argue that the university librarian must have a good grasp in the management of human resources and a proper understanding of the psychological functioning of the individual. This, according to the authors will lead to the achievement of the goals of the library and self-actualization of the employees. Motivational qualities are therefore, what the university librarians need to give of their best. Motivation according to Luthans in Ogunrombi and Elogie (2009) is a process that raises, energizes, directs and sustain behaviour and performance, adding that it stimulates people to action to achieve the desired tasks.

Okpaleke and Uwaifo (2012) carried out a study on the relationship between librarians' background and adopted leadership styles in selected Federal University Libraries in Nigeria. The objectives of their study were to determine the leadership style of librarians, the predominant style amongst them, and the influence of their background on their styles. The findings of their study showed that librarians adopted autocratic, participative and delegative styles in their administration, with the participative style being the most adopted.

The findings from the above study show that librarians, despite the fact that they used participative style most often, used a mixture of styles to achieve desired objectives since the choice or dependence on one style may lead to failure. It could therefore, be argued that the success of librarians in the attainment of set objectives at all times depends to a great deal on the performance and commitment of their subordinates towards the task of achieving the overall objectives for which they were all employed and the traits and behaviour of the head librarian towards them. Consequently, if the subordinates are disenchanted or less committed, no leadership style is enough to achieve desired goals. Rather, the personal qualities inherent in a leader rather than the style of m

anagement could enhance productivity.

Research Method

The descriptive survey research method was used for this study. Nworgu (2006) described descriptive survey research method as that which aims at collecting data on, and describing in a systematic manner, the characteristics, features or facts about a given population. The method was relevant to this study because it intended to collect data on and describe the leadership qualities inherent in university librarians in Niger state from the library staff. The population of the study was 81 comprising 52 and 29 academic librarians and para-professional library staff from Federal University of Technology, Minna and Ibrahim Badamasi Babangida University, Lapai respectively. This category of staff was chosen for the study because they obtain qualifications and experiences which put them in a better position to judge the leadership qualities of their University Librarians. Questionnaire was drafted and administered to elicit response from the population covered by the study using one trained research assistant for each library. In addition to that, interview was conducted with some senior professionals of the libraries. Data gathered were analysed using descriptive statistical analysis involving frequency of occurrence and percentages.

Data Presentation and Discussion

Copies of Questionnaire Administered	Copies of Questionnaire Returned	Percentage (%)
81	76	94

Table 1: Response Rate

Table 1 shows that 81 copies of questionnaire were administered while 76, representing 94% were retrieved and found usable.

Responses	Frequency	Percentage
Yes	76	100
No	0	0
TOTAL	76	100

Table 2: If the universities have at one time or the other failed or granted partial accreditation of some courses as a result of inadequacies from the library.

Table 2 reveals that all, 76 (100%) of the respondents agreed that certain courses have at one time or the other failed or granted partial accreditation as a result of inadequacies from their libraries.

Responses	Frequency	Percentage
Yes	54	71
No	22	29
TOTAL	76	100

Table 3: If inadequacies of the libraries could be attributed to lack of leadership qualities of the University Librarians

Table 3 shows that majority, 54 (71%) of the respondents agreed that the inadequacies of the libraries in meeting with the accreditation requirement of certain courses could be attributed to the lack of leadership qualities of their respective University Librarians while only 22 (29%) of them did not agree.

S/N	Qualities	Frequencies	Percentages (%)
1	Ambitious	0	0
2	Broadminded	45	59
3	Caring	70	92
4	Commitment	76	100
5	Competent	76	100
6	Confident	76	100
7	Consistent	76	100
8	Cooperative	72	95
9	Courageous	76	100
10	Creative	76	100
11	Delegative	76	100
12	Dependable	76	100
13	Determined	76	100
14	Enthusiastic	65	86
15	Ethical	69	91
16	Evaluative	71	93
17	Fair minded	69	91
18	Flexible	25	33
19	Forward looking	58	76
20	Highly educated	76	100
21	Honesty	76	100

22	Imaginative	67	88
23	Initiative	73	96
24	Inspirational	73	96
25	Intelligent	76	100
26	Interested in feedback	71	93
27	Open minded	70	92
28	Optimistic	73	96
29	Organised	76	100
30	Positive attitude	69	91
31	Proactive	76	100
32	Purpose driven	76	100
33	Resourceful	76	100
34	Respectful	68	90
35	Result oriented	76	100
36	Social	73	96
37	Supportive	69	91
38	Trust worthy	76	100
39	Upright	65	86
40	Visionary	76	100

Table 4: Qualities expected of University Librarians to effectively manage available resources to attain the objectives of their libraries in the 21st century

Table 4 reveals that all, 76 (100%) of the respondents expected University Librarians to be committed, competent, confident, consistent, courageous, creative, delegative, dependable, determined, highly educated, intelligent, organized, proactive, purpose driven, resourceful, result oriented, trustworthy and visionary. These qualities were closely followed by 73 (96%) of the respondents who argued in favour of initiative, inspirational, optimistic, and social among others. At the bottom of the expectations were that their librarians should be too flexible and ambitious as rated by 25 (33%) and 0 (0%) of the respondents respectively.

Discussion of Results

The findings in Table 2 revealed that all the respondents agreed that their universities have at one time or the other, failed and or been granted partial accreditation of some courses as a result of inadequacies from the libraries. This position corresponds with the result of interview conducted with some senior professionals of the two libraries. They were categorical when they opined that between 2004 and 2014 the stringent guidelines coupled with the lackadaisical attitude from TETFund and University Librarians respectively, the financial support from TETFund could not be accessed to acquire current, relevant and adequate information resources. That according to them left their libraries with mostly outdated information resources which could not meet the National Universities Commission (N.U.C.) accreditation teams' requirement for some courses offered by the universities.

In Table 3, majority of the respondents, 54 (71%) agreed that lack of leadership qualities of their university librarians could be attributed to the reasons why their libraries could not meet up with the accreditation requirements of the N.U.C. on some courses. This argument was also supported by the result of the interview conducted with some senior professionals who argued that their librarians were not consulting with them on matters that affect library development. They observed that meetings which are supposed to be ideal fora for sharing ideas and taking good decisions were not organized at all. Consequently, every staff was on his own. This may be as a result of management style adopted by the University Librarians. Okpaleke and Uwaifor (2012) in this respect, discovered that librarians adopted

The Leadership Qualities of University Librarians in Nigeria in the 21st Century

autocratic, participative and delegative styles of management in their libraries. However, the authors argued that though participative style was most often adopted, there is the need to combine the three since the choice or dependence on one style may lead to failure in achieving desired objectives. From the findings of this study, these researchers have however, found out in Table 4 that personal leadership qualities of librarians are what they need to effectively manage human and material resources of their libraries to achieve expected objectives.

Table 4 is a list of qualities expected of University Librarians in the 21st century, though not exhaustive, from which the respondents were to make their choices. On top of the choices were 76 (100%) of the respondents who expected their Librarian to be committed, competent, confident, consistent, delegative and highly educated among others. These options corroborate those listed in the website on leadership (www.leadership.uoregon.edu/resources/exercises-tips/skills/leadership-characteristics). Ogunrombi and Elogie (2009) also supported this finding while contributing to the various ways university librarians could motivate staff to achieve desired goals. The authors observed that the University Librarian must have a good grasp in the management of human resources and proper understanding of the psychological functioning of the individual. It is the hope that if the librarians possess qualities that were highly rated, it could serve as an impetus for the attainment of the objectives for which the university libraries and the parent institutions were initially established.

Conclusion

From the findings of this study, it was concluded that the failure of the university libraries to meet accreditation requirement of the National University Commission (N.U.C.) is sine qua non to failing to meet the aims and objectives for which the libraries were established. The injection of a proactive, social and energetic librarians becomes imperative to tackle the challenges faced by libraries in a bid to move forward in the 21st century.

Recommendations

The following recommendations were made to solve the problem of leadership qualities in academic libraries in the 21st century:

1. Aspiring university librarians should possess personal qualities that could enhance their leadership capability of university libraries.
2. University librarians must be trained and retrained on various aspects of university library and staff management for effect service delivery.
3. The University librarians should be proactive in discharging their responsibilities by carrying along their professional colleagues and other staff in order to achieve the objectives of their libraries.

References

- Abioye, D. (2014). Leadership: A biblical perspective on leadership. In T. Abioye, C. Awonuga and A. Amuwo (Eds.). *Leadership and innovation in Africa's development paradigm*. Ota: Covenant University Press.
- Abubakar, U. N. (2013). Motivational factors affecting job performance of academic libraries in university libraries, Niger state, Nigeria. *Journal of Information Resource Management (JIRM)*, 3(2), 36-42.
- Cebula, N. C. E., Eggers, J., Fajardo, M. D., Gray, J., & Lantz, T. (2012). *Achieving performance excellence: The influence of leadership on organizational performance*. Washington: Department of Justice, National Institute of Corrections. Retrieved from www.nic.gov on 26th November, 2014.
- Fatokun, J. O., Salaam, M. O. & Ajegbomogun, F.O. (2010). The influence of leadership style on the performance of subordinates in Nigerian libraries. *Library philosophy and practice*. Retrieved from <http://unllib.unl.edu/LPP/fatokun-salaam-ajegbomogun.htm> on 3rd November, 2014.
- Imoke, L. (2014). The innovative leader as a cultural agent of change. In T. Abioye, C. Awonuga and A. Amuwo (Eds.). *Leadership and innovation in Africa's development paradigm*. Ota: Covenant University Press.
- Nworgu, B. G. (2006). *Educational research: Basic issues and methodology*. Nsukka: University Trust Publishers.
- Ogunrombi, S. A. & Elogie, T. A. (2009). Staff motivation and productivity in John Harris Library, University of Benin, Benin City, Nigeria. *Library and information management forum: Journal of Ahmadu Bello University Library Complex*, 11(1 and 2), 33-41.
- Okpaleke, J. S. & Uwaifo, S. O. (2012). Relationship between librarians' background and adopted leadership styles in selected federal university libraries in Nigeria. *Middlebelt journal of library and information science*, 10(1), 224-239.
- Popa, B. M. (2012). The relationship between leadership effectiveness and organizational performance. *Journal of defence resource management (JoDRM)*. Issue 01/2012 pages 123-127, on www.cceol.com
- Turnbull, S. (2008). The 21st century leader. *Leadership trust*. Available at leadership.org.uk. Accessed on 5th July, 2015

An Analysis of the Fictional Structure in Nineteen Eighty-Four

Hasan Çakir

Necmettin Erbakan University,
Education Faculty
English Department
Konya, Turkiye

Abstract

In this study, an analysis of the structural organization in *Nineteen Eighty-Four* is presented. The fictional structure of the novel is analysed under four headings: subject, style status, and tone. Substantial attention is paid to illustrate the success of the writer in writing such a romantic fantasy. However, great care is taken to state the literary value of the elements used by the writer in the creation of the novel as a work of art.

Keywords: Dystopia, Satire, Allegory, Orwell

Introduction

The structure in fictitious works is the overall organisation of the work as a piece of literature. The division of works into chapters may function as a road sign to get a superficial insight into the structure of a given work. But this is not a sufficient clue to trace all the lines of the structure. All the elements included in and excluded from the work are of highly significant importance for the structure. The theme and its colourful elaboration with realistic or fantastic details enhance the structure. A convincing story and a proper plot organisation stemming from it have an artistic effect on the structure. Many people involved in the story and their distinctive characterisation contribute very much to the structure.

The setting in which the story takes place is an integrative element. The more convincing the place and the milieu of people around the main hero, the more believable the work is likely to be. Last but not least, the language and style is the dough of the structure. The language must be suitable to the character's nature and sophisticated or ignorant personality. The diction diligently dealt by the writer will, of course, be instrumental in rendering the raw material of the theme into an art form. Furthermore, the point of view is the essential source as to whether we, as readers, believe the story and then accept the identification of the protagonist to feel the tension in the work. The vantage point through which the story is revealed and the perspective of how it is seen are the elements increasing the literary value of a work.

The success of a master writer in these literary components determines the compactness or a slackness of the structure in a work. What follows from these explanations is that the structure encapsulates the total texture of a work as an imaginative creation of literature, not to mention the contribution of original and personal talent of the writer. His own background and worldview, prejudice and preference, mentality and ideology frequently are reflected in the work in an overt or covert context. His unique skill to impose them on the work or his effort to conceal and avoid pouring them into the work shapes and improves the work. In addition, his narrative technique spices the work and adds a disparate taste into the structure. Repetition of an element, the leitmotif, the contrast characters and the situations, the mystery and fantasy, the prophecy and rhythm and the patterning, reiteration, flashbacks and foregrounding, the strenuous conflict, the scene and smooth transitions between them. All these narrative techniques present or absent are of highly significance in the structure. The success or failure in realisation of these components indicates the mastery of the imaginative writer. So does the success of the structure in fictitious works of art, either in a novel, drama, or in a short story etc.

Now the structure in *Nineteen Eighty-Four* shall be examined. The work of art cannot be cut into its parts. To illustrate the concept of structure, this novel will be dissected into its literary organs.

1. The Subject

The subject in *Nineteen Eighty Four* is Winston Smith's revolt against the party rules in a totalitarian state. The party has an absolute power and authority over the party members. It exerts its authority on them constantly and keeps a check on their every action, word, gesture and thought. It does so because it cannot tolerate even an individual thinking against the rules. The totalitarian authority fears that such a person can topple the structure of totalitarianism. There is such a person. It is Winston Smith, who works in the Records Department of the Ministry of Truth, which concerns itself with news, entertainment, education and the fine arts. There is an opposition in Winston Smith against the news on the telescreen. It is his own work to do distortion of them, of which he is certainly aware. Winston disgests the eradication of the past constantly carried out by the

party. He hates the changes always made on the language to rub of the remains of the past and to narrow the range of thought and its displacement with a new but artificial language whose vocabulary gets smaller every day. Smith resents the ever-checking of his life and his psychologically and socially harassment being a party member. No longer does he want his every movement to be detected by the telescreen:

“...The telescreen received and transmitted simultaneously. Any sound what Winston made, above the level of a very low whisper, would be picked up by it; moreover, so long as he remained within the field of vision which the metal plaque commanded, he could be seen as well as heard... It was even conceivable that they watched every body all the time.” (NEF: 6.)

His hate for the state forced him to do something subversive. Smith decided to keep a diary in order to communicate with the future, with the unborn generation to transfer into the paper, the interminable restless monologue that have been running inside his head, literally for years. That is a simple crime for him to be punished by death, or at least by twenty-five years in a forced labour camp. Smith hopes that the state will collapse some day of itself. He believes that the state based on absolute tyranny cannot live forever. He looks for some people who share the same hope and belief as he has. He thinks that a man named O'Brien shares his belief, but he makes a great mistake, for O'Brien is a member of the inner party and holder of some post so important and remote that Winston has only a dim idea of its nature. Winston is arrested and tortured and released after O'Brien has made him believe in the party principles with torture. Smith's struggle is finished; he has won the victory over himself. Smith began to love Big Brother, an invisible leader for the party.

In *Nineteen Eighty-Four*, Orwell characterizes and shows the likelihood that a totalitarian power can usurp the authority of a state and come to exert its hard discipline on the people. This is one of the great themes Orwell repeatedly works out in his novels. Asserting that Orwell wrote a masterpiece of political speculation, Crick (1980:570) says:

If totalitarianism becomes our common way of life, then all other human values, liberty, fraternity, social justice, love of literature, love of plain speaking and clear writing, belief in a natural moral decency, among ordinary people, love of nature, enjoyment of human oddity, and patriotism would perish. Orwell argued for the primacy of the political only to protect non-political values. So while he was primarily a political writer and *Nineteen Eighty-Four* may assume his own and known political values, yet it does not make them explicit. It is a flawed masterpiece of both literature and political thought.

Nineteen Eighty-Four parodies totalitarian power and Orwell constantly scorns and mocks the maltreatment and violation of human rights in totalitarian regimes, which he deeply understands and regards as the greater menace to humanity.

2. The Tone

George Orwell's attitude towards his subject is certainly a satirical one. Orwell did understand the political conjuncture of his time and satirized it in *Nineteen Eighty-Four*. The satire is not at the level of words, but has a quality penetrating into the whole of the book. His vision of the world in this conjuncture is the recurrent theme of the book. Williams (1985:99) suggests that three themes predominate the central structure on which, at the level of ideas, the book is founded. First, there is the division of the world into three super-states, which in shifting alliances are in a state of limited but perpetual war. Second, there is the internal tyranny of each of these states, with a specific version of the relations

between social classes and a detailed presentation of a totalitarian society, which has been developed beyond both capitalism and socialism. Third, there is the exceptional emphasis on the control of a society through ideas and means of communication, backed up by direct repression and torture but mainly operating through ‘thought control’.

In order to achieve a coherent satire of that political conjuncture of the world, Orwell composes the powerful tragedy of Winston Smith’s struggles in a natural and plausible way. He naively supposes that he can work secretly to harm the system. This is the usual mistake, on which traditional tragedies are based. His decision to violate the rules of the party is a tragic mistake on the part of Winston Smith, who has conceded that he is not or will not be able to succeed. In this sense, he is a tragic character. Weatherly (1984: 88) states the similar view when he says: “surely *Nineteen Eighty-Four* is a literary work of the highest order – a tragedy meeting many of Aristotle’s standards, and reflecting Orwell’s own sense of tragedy as defined in “*Lear, Tolstoy, and the Fool*” “A tragic situation precisely exists although virtue does *not* triumph when it is still felt that man is nobler than the forces which destroy him.” Orwell successfully develops Smith’s character and narrates his tragic story very well.

It is possible to find in *Nineteen Eighty Four* many tragic elements such as *hamartia*, *peripeti* and *anagnorisis* together. We can also find such tragic elements in the story as the diary Winston Smith keeps and the book he reads. In the development and revelation of the attitude towards the subject, the function of this diary and Goldstein’s book cannot be overlooked. The book and especially, the diary function as did the chorus in the ancient Greek tragedies.

The diary and Goldstein’s book are static of their nature. They are unlikely to have an active part in the story and therefore outside the actions. However, they have an informative though static quality of their nature. The application of them in the story is an interesting technique to develop the plot and character. Orwell puts them into a good use, and imposes on them the function to display and develop his attitude throughout the story.

3. Status

3. 1. Setting, Atmosphere and Time

Orwell places Winston in a utopic country on a utopic world different from ours. Orwell goes beyond fictional world built like ours with the technique of mimesis. Fictitious world is more or less similar to ours. But his is quite unlike our world. The world is splitted into three great super-states, Eurasia, Oceania and Eastasia. These super-states are permanently at war. These belligerent states add nothing to the wealth of the world, since whatever they produce is used for the purpose of war. Their object of waging a war is always to be in a better position in which to wage another war.

Eurasia comprises the whole of the northern part of the European and Asiatic landmass, from Portugal to the Bering Strait. Oceania comprises the Americas, the Atlantic Islands including the British Isles, Australasia, and the southern portion of Africa Eastasia, smaller than the others and with a less definite western frontier, comprises China and the countries to the south of it, the Japanese islands and a large but fluctuating portion of Manchuria, Mongolia and Tibet (NEF:151)

Winston Smith is a citizen of Oceania ruled by the party of a totalitarian regime. He is forced to love that state and its leader Big Brother as the usual case with any totalitarian state. Love for this leader constitutes the most fundamental source of authority. Beauchamp (1973: 68) explains the love and loyalty of the citizens for the totalitarian

state as follows: “ In dystopian fiction, the embodiment of the state is always such a figure: Zamiatin’s Well-Doer, Orwell’s Big Brother, Huxley’s World Controller, even Forster’s Machine (in “The Machine Stops”), all of them incarnation of the Grand Inquisitor. And no clearer confirmation of the “displacement” of Eros which Freud saw underlying all authority can be found than in the erotic language Orwell’s disobedient Adam uses to express his ultimate submission “I love Big Brother.” In the megacivilization of utopia, man’s whole duty is to love the führer and serve him.”

The inner party in totalitarian Oceania rules the whole country and keeps control on everything through the four Ministries. The ministry of Truth feeds the people with lies in the name of news and education. The Ministry of peace runs permanent wars. The Ministry of Love keeps watch on every thought, action the people make through the thought police. The Ministry of Plenty deals in scarcities. There is telescreen everywhere, which spots every gesture and sound. The language, the past and even the present are not only changed but also changed continuously. The remains of the past are eradicated completely. Telescreen continually indoctrinates the people with lies and fictitious statistics about the national revenue. The party produces a newspaper containing almost nothing except sport, crime and astrology, sensational five-cent novelettes, films oozing with sex, and sentimental songs which were composed entirely by mechanical means on a special kind of kaleidoscope known as versificator. There was even a whole sub-section which was called pornosec, in Newspeak engaged in producing the lowest kind of pornography, which was sent out in sealed packets and which no party member - other than those who work on it - was permitted to look at.” (NEF:38)

In Oceania no one dares to speak with each other because he may be a spy for the thought police: There is no individual life for the party member. Even to think different from the three party slogans means to be “vaporized”, which means there is no record of a citizen killed by the thought police in its persecutions.

In such a setting, Winston Smith’s strong struggle makes him a true tragic character. He yearns the nostalgic past, a sort of ancestral memory. He loves a girl named Julia. He believes in the parols that live different free like animals. He tries to find furtively someone holding the same hope that the state will certainly collapse someday.

As to the atmosphere, it is that of hopelessness and control.

Outside, even through the shut windowpane, the world looked cold. Down in the street little eddies of wind were whirling dust and torn paper into spirals and though the sun was shining and the sky a harsh blue, there seemed to be no colour in anything except the posters that were plastered everywhere. Big Brother is watching you. (NEF:6)

It is hard to tell whether this extract is more likely to be symbol for the scene in which the story will take place.

As to the setting, it is really a fantastic one. Orwell displays an interesting “mindstyle” in time in this fantastic novel. In his utopic world, the clocks behave differently from the clocks we know.

It was a bright cold day in April, and the clocks were striking thirteen.” (NEF:5) At this moment O’Brien glanced at his wrist watch, saw that it was nearly eleven hundred, and evidently decided to stay in the Records Department until the Two Minutes Hate was over...” (NEF:13)

Both these extracts are odd and linguistically transparent, so they strongly postulate a fictional world at variance with the world in which we live to an irreconcilable extent. In creating a world at odds with ours, I assume that Orwell tries to show the generalized nature of totalitarianism. Regardless of time and place, totalitarianism possesses the same identity and authority with the same structure anywhere any time. This inference about the nature and structure of totalitarian regime is analogous with the views that Freedman (1984: 97) has when he says: “Orwell’s programmatic satire contains a (predictably neater and cleaner) split. Most of the satiric theses are part of a generalized satire of totalitarianism. Orwell constructs a “pure” totalitarian model, and O’Brien is even made to refer to the Roman Catholic Inquisition and the Stalinist purges as comparatively crude and ineffective. Nonetheless, Orwell does also include a considerable amount of specific, allegorical satire. Its primary targets are Roman Catholicism (and to some extent, Christianity in general) and the Soviet Communism. The anti-Communist elements are reasonably obvious. They include the fact that Ingsoc (English Socialism), the ruling ideology, and the system of Oceania, renders property nominally collective; the constant use of terms such as “comrade”; references to “the Revolution”, which apparently established the rule of the party; and various details modelled after the Stalin-Trotsky split and the great Soviet purges of the 1930s. Such elements are probably the most widely known aspects of the book.”

By focusing on the limited life of Winston Smith in such a tough and harsh regime, Orwell tries to show the merits of freedom, natural and universal right of Man. Orwell also brands as tyrannical regime any system that violates the right to live, to think, to act and to express freely. And he puts a veritable emphasis on the freedom of expression because the other types of freedoms follow from that of expression:

“Freedom is the freedom to say two plus two make four. If that is granted, all else follows.” (NEF: 68)

3. 2. Point Of View and The Plot

The point of view in *Nineteen Eighty-Four* is that of the third person omniscient. It is perhaps the best view because the story could have not revealed through first person central narrator; namely through Winston Smith, possessing a limited freedom to be present freely everywhere involved in the story. Winston Smith lives in a country where everything is controlled. That is why the omniscient narrator is used, which overlaps with the writer who tells the story. But most of the story is revealed through Winston’s perspective. It is Winston, the protagonist, who feels, thinks and also experiences the events throughout the story. Suggesting the same view, Lonoff (1992:35) says that Orwell needed a spokesman for his views, an individual who, in looking outward and inward, would illuminate the evils of a system. So although he kept the story in the third person, he wrote it from Winston’s perspective.

The plot in the book is a linear one, in which the story is narrated from the beginning to the end. The story progresses through a series of scenes, which follow each other in a consecutive way. Winston Smith, the main hero in the novel, wants to leave a print about the past so that the future generation should compare the present with the past by means of his diary. He also tries to find anybody whose thought parallels to his. Thus, when he betrays himself, he is arrested, tortured, remedied of the “harmful” thought.

3. 3. THE Characters

Nineteen Eighty-Four involves only a few significant characters as in tragedies. Of these dramatis personae, the most important one is Winston Smith, a round character changing as the story is progressing. The reader watches his story, or rather, experiences

the events, which behold him. His description has been scattered, and explained points by points. Orwell develops Winston Smith as a character in a description made from physical to psychological aspects.

His hair was very fair, his face naturally sanguine, his skin roughened by coarse soap and blind razor blades... (NEF: 5)

Winston stopped writing, partly because he was suffering from cramp. (NEF: 11)

The physical jerks would begin in three minutes. The next moment he was doubled up by evident coughing fit which nearly always attacked him soon after waking up. It emptied his lungs so completely that he could only begin breathing again by lying on his back taking a series of deep gasps. His veins had swelled with the effort of the cough, and the varicose ulcer had started itching... (NEF: 29)

Winston Smith is also a well-informed and conscious man who clearly knows the party structure and hates it. He remembers the past with a strongly retentive mind never stopping to reason. He also has the belief that the system will certainly come to an end. Winston is the only altruistic person thinking the other people in this country. Always resentful to the state destroys everything, he is successful in his work at The Ministry of Truth.

Julia is another character, a young girl working at the Fiction department of The Ministry of Truth. She is a bold-looking girl of about twenty-seven, with thick dark hair, a freckled face, and swift, athletic movements. She is fresh, young and healthy. She seems to be a spy for the thought police because of her physical charm. Julia is successful in wearing countenance and changeable demeanour. She obviously has a practical cunning, which Winston lacks, and she seems also to have an exhaustive knowledge of the countryside. But being clever at school, she has been captain of the hockey team and had won gymnastic trophy two years running. She had been a troop-leader in the spies and branch secretary in the Youth League before joining the junior Anti-Sex League. She had always been an excellent character.

The other character is a man named O'Brien, a member of inner party and holder of an important post. He is a large and muscular man with a thick neck and a coarse humorous brutal face. In spite of his formidable appearance, O'Brien has a certain charm of manner with an appearance of being a person possible to talk to. Later in the story, he proves to be a member of the thought police. His influencing appearance has deceived Winston completely.

The other characters play no part in the story because of a little importance. The reader observes them in the story as dummies or slot-filling character sometimes functioning as elements of the scene, or sometimes as the background elements to draw a contrast between their own ineffective character and that of Winston.

4. Style

Orwell's style is easy and formal. He writes this novel as he used to write for the *observer*, the newspaper for which he has worked. His is the style of a working journalist. His choice of words is formal and often with lexical meaning. There is almost no abstraction, and archaism. His narration is as clear as his mind and his common sense. The reader therefore grasps his meaning easily. Nouns, adjectives, adverbs, and verbs are formal. To my way of thinking, Orwell's intention behind being so diligent to chose

formal words instead of colloquial ones is to state his story in a precision and transparency, a quality observed in scientific writing. In this way, he has been highly successful in preventing any unnecessary intruding association from occurring to the reader's mind and taking away from the flow of the story.

Orwell has a preference for passive verbs, and the structures to reflect the limited activities of the protagonist in a totalitarian state where the party controls everything. Through other literary tools, Orwell undercuts Winston's agency and also allows readers to experience how truly passive Winston is in this nightmarish utopic country. The structures that downplay the agency in English include passive voice, nominalization, depersonalisation, negation, perfect aspect and subjunctive mood of the verbs, copulas or the linking verbs, intransitive and resultive verbs, existential *it* and presentational *there* structures, along with cleft sentences. By playing words and manipulating the language, Orwell has the reader feel Winston's tragic and powerless situation, one of the foregrounded theme in *Nineteen Eighty-Four* – the powerlessness and passivity of the individual under a totalitarian regime. Kies (1992:48) also points out that characteristic of style when he says:

Orwell illustrated the futility through the fate of Winston Smith; however, it is not the level of plot that the reader can best appreciate that powerless-ness. Rather, it is through the language that Orwell used to describe Winston, to narrate his action, and to develop his character that the reader perceives not only the futility of struggle but also Orwell's sensitivity to both the use and meaning of the language. Specifically, Orwell manipulated the expression of agency so that Winston Smith is never seen as active or in control of any situation.

When necessary, Orwell usually uses sense-appealing words so perfectly that these words take the reader to the situations in which Winston has been and the places where the action has occurred. As a result, the reader participates in the feelings and sufferings of the hero as he reads the novel, imagining the story like a piece of movie.

The expression on his face changed. The annoyance passed out of it and for a moment he looked almost pleased. A sort of intellectual warmth, the joy of the pedant who has found out some useless fact, shone through the dirt and scrubby hair. (NEF: 185)

Here are examples of loose-structured sentences. Orwell uses such sort of sentences from the beginning to the end of the story. As Leech and Short (1981: 228) explains that the most common type of complex sentence is the loose structure, in which trailing constituents predominate over anticipatory constituents. Unlike periodic sentence structure which saves its clause to the end, loose sentence structure is more *natural* in that it makes the information easy for the addressee, by reducing the burden to remember syntactic information that has to be used in decoding. In this connection, the qualities of loose-sentence structure are easiness, and informativity, often found in an unconstrained use of language. In relating his story with that structure, perhaps Orwell's aim is to be direct and natural. In my judgement, he achieves his objective perfectly well.

By lack of understanding they remained sane. They simply swallowed everything and what they swallowed did them no harm, because it left on residue behind, just as a grain of corn will pass undigested through the body of a bird. (NEF: 128)

Here is an example of simple simile. It is highly suitable for explaining the ignorance of the people who lack the power to reason and consequently the interest in revolt against the totalitarianism. Orwell has no propensity to use figurative language elaborated with images and tropes. It is perhaps that he does not need. We must look for the justification in his aim: he also wants to appeal to the mind as well as to the basic senses, a five-flanged door to emotions.

Conclusion

Of the literary approaches applied in literary appreciation, the textual one is the most descriptive but the most objective. In order to scrutinize *Nineteen-Eighty Four*, by George Orwell, we adopted the textual approach. However, much care is taken to state the literary value of the elements used by the writer in rendering the novel as a work of art.

Orwell works on a bleak vision of future in *Nineteen Eighty-Four*. He predicts that the world will be divided into three regions between three super states. They will perpetually fight with each other to enlarge their political and military zone. His stylistic features are suitable to the characterization of the protagonist and the general narration of this satirical novel. Orwell's serious tone toward his subject reveals the seriousness of the thematic concerns. For the reflection of the message and the tone, the fictional world is materialized with distinct life of the protagonist in a totalitarian state. The setting and atmosphere are those of horror, absolute control, and tyrannical torture. The protagonist is defeated in the tragic resolution of the work.

Orwell's narrative talent shapes the structure in *Nineteen Eighty-Four* and places a different pleasure in its structural elements. He repeats some elements, depicts contrast characters, presents interesting situations, sets up seriously challenging conflict, and keeps a certain fictional pattern. Additionally, he successfully controls the rhythmic pace of the actions. The mystery or suspense, fantasy or reality, message or prophecy efficiently increases the quality of the novel. The synopsis or reiteration and some scenic presentation of several actions, including flashbacks or foreshadowing are certainly functional in the structure of the work. The artistic success in realisation of these narrative components indicates the mastery of the writer.

References

- Aristotle. (1450). *Poetics*. (Translation: İsmail Tunalı.1987). *Poetika*. İstanbul: Yunan ve Latin Klasikleri, Remzi Kitabevi.
- Beauchamp, G. (1986). Of Man's Last Disobedience: Zamiyatın's We and Orwell's 1984. *Critical Essays on George Orwell*, Bernard Oldsey and Joseph Browne (Ed.), Boston, Massachusetts: G. C. Hall and Co.
- Crick, B. (1980). *George Orwell – A Life*, Harmondsworth, and Middlesex: Penguin Books.
- Cuddon, J. A. (1976). *A Dictionary of Literary Terms*. Harmondsworth, Middlesex: Penguin Books. (Ref: reprinted 1984).
- Freedman, C. (1986). Antinomies of Nineteen Eighty-Four. *Critical Essays on George Orwell*, Bernard Oldsey and Joseph Browne (Ed.), Boston, Massachusetts: G. C. Hall and Co.
- Kies, D. (1992). Fourteen Types of Passivity: Suppressing Agency in Nineteen Eighty-Four. *The Revised Orwell*, Jonathan Rose (Ed.). East Lansing: Michigan State University Press.
- Leech, G. N. & Short, M. H. (1981). *Style in Fiction*. New York: Longman Group.
- Lonoff, S. (1992). Composing Nineteen Eighty-Four: The Art of Nightmare. *The Revised Orwell*, Jonathan Rose (Ed.) East Lansing: Michigan State University Press.
- Orwell, G. (1949). *Nineteen Eighty-Four, (NEF)*. Harmondsworth: Penguin Books, Reprinted. 1970.
- Weatherly, J. (1986). The Death of Big Sister: Orwell's Tragic Message. *Critical Essays on George Orwell*, Bernard Oldsey and Joseph Browne (Ed.), Boston, Massachusetts: G. C. Hall and Co.
- Williams, R. (1985). *Orwell*, New York: Harper Collins Fontana Press.

Gaming and Simulation in English Language Teaching: A Symbiotic Interweave Towards Language Efficiency

Manjusha Dhumal

Head and Associate Professor
Prof. Ramkrishna More College, Pune
Department of English

Abstract

India is a nation of linguistically diverse classes. Hence the daunting task of connecting the entire nation falls on the English Language. This renders English Language Teaching all the more demanding, intricate, and exceptionally challenging. Teachers have to develop and initiate their own individual and innovative strategies of teaching. Teaching a language caters to developing and excelling in the four domains of language learning viz. Listening, Speaking, Reading and Writing and has to be made highly learner-centric. Language learning should be implemented at various levels of usage. Learning a language theoretically becomes strenuous and complex to apply. Gaming and simulation play a dominant role in language learning and nurturing the learners on a pedagogical, didactic, as well as psychological level. Simulation refers to a task based activity in which the real life situations are explored. This type of learning has no barriers and can be applied or implemented to all age groups. This paper will focus on the role of games and simulations executed in a class with the objective of teaching English as a foreign language, and enhancing and enriching its learning experience towards ultimate perfection.

Keywords: Gaming, Simulation, Language, Role-play.

Introduction

Communication is the chief function of language and has to be syntactically correct along with pragmatic as well as contextual accuracy. Moreover, fluency in language appends a spark to communication. Language learning is an approach to make associations and links with the outside world and this has to be implemented at various levels of usage. Theoretically taught language becomes tedious and boring with no effective results. Grammar based monotonous teaching often leads to disinterestedness in the language learning process consequentially with no positive outcome. Knowledge of language can widen avenues and minds and create empathy and understanding. The more you know a language, the more profound and meaningful those connections can become. Learning a language needs daily and consistent practice over a period, in addition to a willingness to communicate. Putting in a lot of effort is required to attain fluency in language learning. There are no shortcuts whatsoever.

As far as the scenario in India is concerned, there is plurality of situation in the classroom with students coming from varied linguistic, communal, social, cultural and economical background. Consequently, an innovative, creative expertise is in demand to tackle the situation. At the same time language learning should be more relaxing and entertaining than demanding and stressful. There is a new move to teach English and bridge the gap between the English medium schools and the government schools. There is a widespread demand for learning English." Indian English "has been accepted as a legitimate variety the world over resulting in the need to develop teaching methodologies to suit the state of affairs.

Methods of Research

In recent years, there has been a great amount of experimentation and educational trialing related to language learning processes. A review of research reveals extended periods of language socialization into sophisticated communicative practices (Verghese, BV, (2002)). Language is used as a tool for self-identity as well as cultural identity and development (Verghese, BV, 2002). Visual and kinesthetic learning are more effective, imbibe superior sensibility, and have a greater learning impact (Verghese, BV, (2002)). It inculcates quality learning through interest and infuses learners with a long-term retention power and ability to revive it efficiently. Hence, gaming and simulation are the closest training to application and therefore, are effectual tools in the process of learning a new language. Being fluent in second language gives a huge advantage when it comes to communication, travel, work etc.

Findings

Games and fun based activities are a vital part of teaching English as a foreign language. Whether you are teaching adults or children, games enthuse up your lessons and make certain that your students will leave the classroom demanding more. Games can be used to warm up the class before your lesson begins during the lesson to give students a break when you are tackling a tough subject or at the end of the class when you have a few minutes to kill. There are innumerable games that you can play with your students. Language games are used to test vocabulary, practice conversing, and learn tenses. The list is endless. A good language game pushes the learner to enhance his/her speaking, listening, writing and reading skills of the target language:

With the world entering into digitalization there are wonderful language learning techniques, which might render effective results if the students develop self-discipline and hard

work (Googlecoin, 2016). Just to mention a few, Anki is one such software which is quite popular and which means 'memorisation' in Japanese. It allows users to create their own decks of cards or download pre made decks by other users. It allows studying online or on cell phones, it stores your statistics and also tracks your progress (Googlecoin,2016).

FluentU takes real world videos like music videos, movie trailers, news and inspiring talks and turns them into language learning experiences (Googlecoin, 2013). You are easily able to import words and then you can automatically see images, definitions and examples that have been written for those words. You can even see how the word is used in different videos throughout the site. It tracks your history and provides new and different video clips based on your previous history on FluentU.

Supermemo is another learning software that uses spaced repetition learning methods with the aid of electronic flash cards. These cards can be downloaded from a pre made collection or in some cases merged. Users are prescribed with a card to which they have to respond:

Bravolol teaches you through spellings, pronunciations, visual recognition, and problem solving activities. However, online language games have its own demerits and drawbacks. Learning route accelerates when it is actually taught by a human rather than a passive, unemotional mechanical process. Thus the language teacher is the facilitator, as well as the guide. Learning becomes more effective when action and reaction is involved. It may sound clichéd but traditional language games like scrabble, Pictionary, Categorising articles with a given alphabet, jumbled up words or sentences etc have it so we recompense. The emotions involved, the teamwork, the awards and praises received have a big role to play in the language learning process. There is absolutely no investment in terms of devices, instruments, availability of electricity, internet connection etc. One does not have to be dependent on any external factors. Repetition and consistency speeds up the language learning

Another technique, which assists in the language learning progression and augments the communicative competence, is Simulation or Role-play Simulation heightens interest and excitement in learning a language. It endorses a constant level of newness and freshness while transforming the teacher-student, boss and assistant relationship (Aldrich, Clark: (2009). Erudition happens at varied levels like cognitive, social and emotional. The decision-making experiences that participants accomplish, the increased role awareness, and the ability of simulation to provide a vehicle for free, interdisciplinary communication. The concrete approach afforded by simulation exercises connects the fissure flanked by schoolwork and the real world Aldrich, Clark: (2009). Learners during simulation activity tend to forget that they are students in a classroom and imagine themselves to be part of a simulated environment.

Simulation is an important part of language learning as it bonds learners with other students and the teacher as well who may or may not be a part of the entire activity. Role-play can be helpful and attention grabbing for average and slow learners as it can provide a cover for such students who have some kind of inhibition and who do not mind expressing ideas, feelings, or viewpoints when they are thought of by others. Emotion is an integral part of simulation and it involves gestures and facial expressions, which convey how we feel when we are conversing or are resilient.

There seems to be a lot of evidence in favour of simulation. The pedagogical approach at the school level is student centric. There is an integral connection between language and culture and culture learning is a vital contributor to second language learning (Ferdig, Richard E; Freitas, Sara de, (2012)). For a role play the teacher should provide the students with extensive lexis which will allow them to construct discourse related to daily activities, family, school and child associated activities such as games and grammar limited to present and past tense (Ferdig, Richard E; Freitas, Sara de, (2012)).

Discussion

The teacher should see to it that language learning becomes engaging, enjoyable and memorable. The teacher should be brief and to the point so that the students get more time to enact and play their role. The topic given should be real and relevant. The roles given to the students should be close and applicable to everyday life. A comfortable ambience should be created so the students do not feel nervous and pressed because no one can give a good performance under great stress. Autonomy given to students can aid in the process of finding new words and phrases. Assistance can be provided if the students get stuck for words and expressions. The teacher can intervene and provide appropriate vocabulary.

It is not advisable to jump in and correct every mistake. This can deter the students from performing their best and in the process lose confidence (Feng lui & Yun ding, 2009). Corrections can be made after the role play activity is over. However if the activity is recorded, the students can be made to listen to the recording and try to locate the errors and make self-corrections. Peers can also help in making corrections. Positive and profitable inputs can also be given to them. The teacher should offer comments and advice at the end. Incorporating simulation in the classroom adds variety, enthusiasm, a change of tempo and opportunities to learn language using playway method (Kapp, Karl M, (2012)). It becomes fun learning unlike the rote learning of traditional grammatical rules. Role-play should be an essential part of language teaching class and not just an offbeat event to be conducted occasionally (Google coin, 2016). Role-play is a fun based, motivating activity enabling quieter students to get an opportunity to express themselves. The classroom can be transformed into a micro mini outside world. The teacher while assigning the task to the students should make minor alterations by creating small variations each time.

Simulation facilitates language learning at phonological, morphological, syntactical, semantic, and pragmatic planes. While expressing themselves students learn intonation pattern, word stress and accurate pronunciation, of the words. They are able to comprehend the link between spellings and phonetics. This activity improves vocabulary and lexical competence of the students. They learn several new words, their synonyms, and one word substitute etc. They are trained at using syntactically correct sentences. They are guided, directed and corrected by the teachers for their grammatical errors. Along with learning the language at these levels, simulation also aids at gaining knowledge at semantic level. Students get to know and understand the literal and figurative meaning of the words along with its usage. Language learning becomes successful if the listener is able to perceive the intention of the speaker. Hence simulation helps the student to learn the language at contextual or pragmatic level as both the speakers as well as the listener are active participants in the enactment. Role play enriches the communicative competence of the learners. When the teacher divides the class into different teams, it promotes

competitive spirit amongst the students who wish to excel than the other teams. It is great fun to learn with other living, breathing human beings and a little healthy competition can really boost the morale.

Conclusion

Thus, we observe that diverse strategies are inculcated in the language learning process. Along with language learning, a lot of incidental learning takes place as well. The student who acts as a medical practitioner and recommends the patient to take a course of pills twice a day may need not enter this very profession but will definitely learn and develop a strategy for giving recommendations, instructions or advice. A student enacting the role of a salesman will automatically comprehend the nuances of driving home his point or asserting his ideas thereby developing his communicative ability. Other factors like working in a team enhance confidence, build up leadership qualities, and amplify endurance level of the students. Hence, we can perceive that fun games and simulation go a long way in language learning process and language teachers should imbibe them in classroom teaching.

References

- Aldrich, C. (2009). *Simulations and Serious Games*. San Francisco: Pfeiffer.
- Crookall, D. (1990). *Simulation Gaming and Language Learning*. New York: The University of Alabama.
- Curry, M. (n.d.). *FluentU Language Learning Blog*. Retrieved 7 May, 2016, from www.fluentu.com/blog/best-way-to-learn-a-new-foreign-language-online
- Feng, L. & Yun, D. (2009). Role Play in English Language Teaching. *Asian Social Science*, 5(10), 140-143.
- Ferdig, Richard E; Freitas, Sara de,(2012): *Interdisciplinary Advancements in Gaming, Simulations and Virtual Environments: Emerging trends*.USA
- Googlecoin. (2016). *Googlecoin*. Retrieved 7 May, 2016, from [https://scholar.google.co.in/scholar?q=gaming and simulation](https://scholar.google.co.in/scholar?q=gaming+and+simulation)
- Googlecoin, (2016). *Googlecoin*. Retrieved 7 May, 2016, from www.digitaldialects.com
- Googlecoin, (2013). *Googlecoin*. Retrieved 7 May, 2016, from www.playinfluent.com
- Gray, D. (2010). *Game Storming: A Playbook for Innovators, Rule breakers and Changemakers*. O'Reilly Media Inc, USA.
- Kapp, K. M. (2012). *The Gamification of Learning and Instruction*. San Francisco: Pfeiffer.
- Leadpagesnet. (2015). *Leadpagesnet*. Retrieved 10 September 2015, from <https://my.leadpages.net/leadbox>
- Verghese, BV, (2002): *Creativity in English Language Teaching*. New Delhi: Anmol Publication.

Level of Readiness of Selected Higher Educational Institutions in Region III to Offer a New Program for Physical Education

Anatalia Endozo¹ and Jumel C. Miller²

¹ Angeles University Foundation
Department of Physical Education
Angeles City, Philippines

² Systems Plus College Foundation
Department of Physical Education
Angeles City, Philippines

Abstract

This study was carried out to present the level of readiness of selected higher educational institutions to operate the Bachelor of Physical Education program major in School Physical Education. Specifically, it aimed to evaluate the level of readiness based on the compliance minimum requirements of the of selected higher educational institutions in the region as embodied in the Commission on Higher Education policies, standards and guidelines (PSGs). Part of the study covered the assessment of the actual situation of the institutions based on administration, faculty, curriculum, library and physical facilities using the Commission on Higher Education assessment instrument. The study was a descriptive-qualitative type of research with the use of CHED evaluation instrument to ensure consistency, fairness and objectivity in the implementation of the provisions of the policies, standards and guidelines. Standard evaluation form, documentary analysis and interview were utilized to gather data. The study was conducted in selected higher educational institutions in Region III with their administrators, faculty and personnel served as the principal respondents. Among the notable findings of the study was the need to hire a more qualified dean/head to handle the key positions. Results also emphasized the need to improve the library collections especially for professional holdings, periodical collections and subscriptions. Likewise, documents and pictures presented by selected higher educational institutions helped to validate the actual situation especially in terms of physical facilities which were proven to be of great contribution to positive learning environment in the implementation of the program. It was likewise recommended that the major findings on the reports be further evaluated by the institutions for further compliance of the identified deficiencies to be granted the permit to implement of the program.

Keywords: Readiness to offer the new program for physical education, Compliance with the Commission on Higher Education policies, Standards and guidelines, School physical education, Sports and wellness management

Introduction

The turn of the century marked the beginning of the second century for the profession of physical education. It was the time for physical education to move on from its status as a "second-class" profession to "first class" status, or as put it, to "become the renaissance profession of the new millennium" (Park, 1989). During the 20th century, medicine emerged as the renaissance profession because of the development of a sound scientific base. Substantial scientific evidence supports the role of physical activity in disease prevention and healthy lifestyle promotion, and quality physical education represents the best opportunity to provide all children with physical activity experiences that promote physical activity now and for a lifetime (Masurier, 2006).

Sport is an effective medium through which the energy of the youth can be directed to positive ends. It coincides with the recommendation of the International Charter of Physical Education and Sports (UNESCO, 1978) Article 1 that, "the practice of physical education and sport is a fundamental right for all" and Article 2 "Physical education and sport is an essential element of lifelong education in the overall education system". It is believed that youth regular and early participation in sports will eventually develop a positive values or traits which will be worthy foundation in their adult life. The mandate in the Philippine Constitution affirmed that higher educational institutions recognize the importance of sports in the life of the Filipino youth as mandated in Article XIV, Section 19 that states: "The state shall promote physical education and encourage sports program, league competitions, and amateur sports including training for international competitions to foster self-discipline, teamwork, and excellence for the development of a healthy and alert citizenry". All educational institutions shall undertake regular sports activities throughout the country and in cooperation with athletic clubs and other sectors."

The economic growth witnessed in many countries in Asia has led to significant changes in cultural and social practices. As people become more affluent, their lifestyles and habits reflect their shifting priorities and spending power. In general, people in urban Asia have grown more sedentary in tandem with greater technological advances that offer an escape from physical work and exercise. This trend has raised the concerns of educators who have noted a declining interest in physical education and sports in schools. Educational institutions play an important role in improving the health and wellbeing of the students, especially through physical education, sports and recreation programs. Unfortunately, increasing demands from other curricular areas have resulted in a reduction in time allocation, budget and status for physical education and sports in schools.

UNESCO has a mission to contribute to sustainable human development through educational, scientific and cultural programs. This has led to its role as the lead agency spearheading the United Nations Decade of Education for Sustainable Development (2005-2014) in the Asia and Pacific region. To achieve the goals of the Decade, UNESCO strongly advocates the development of the intellectual capacity, morals and ethics, emotional maturity and physical wellbeing of children and youth, enabling them to become responsible citizens and leaders of the future. (Shaeffer, 2008)

Physical education (PE) is the academic discipline and profession, which focuses on the art and science of human movement (Kroll, 1971) with an emphasis given to sports, fitness and outdoor recreation. Sports refer to four kinds of physical activity: Olympic competitive sports, outdoor games and recreation, exercise and fitness, music and movement (IOC, 1990).

Furthermore, Physical Education as academic discipline and as a profession plays an important role in human development and continues to expand at a fast time. By its very nature, physical education and sports are about participation, inclusion and a sense of belonging. It bring individuals and communities together, highlighting commonalities and

bringing cultural and ethnic divides. Therefore, physical education professionals must do a better job of documenting and studying the evidence of the link between quality physical education and the present and future of physical activity participation. To date, research has demonstrated that programs exhibiting the characteristics of quality physical education lead to increased physical activity levels (Dale, Corbin, & Dale, 2000; McKenzie et al., 2004; Pate et al., 2005; Sallis et al., 1997), improved self-concept (Goni & Zulaika, 2000), increased self-efficacy (Dishman et al., 2004), improved motor skills (Emmanouel, Zervas, & Vagenas, 1992), increased enjoyment (Dishman et al., 2005), increased motivation (Prusak, Treasure, Darst, & Pangrazi, 2004), reduced sedentary behaviors following graduation from high school (Dale & Corbin, 2000), and increased physical activity over the long-term in women (Trudeau, Laurencelle, Trembley, Rajic, & Shephard, 1998). In addition to the existing research (Trudeau & Shephard, 2005), large-scale interventions with significant physical education components are being conducted (e.g., the Trial of Activity for Adolescent Girls and Lifestyle Education for Activity Program) and will provide insights into physical education's impact on youth physical activity (Pate et al., 2005).

It affirms that Physical Education and Sports provide an opportunity to learn skills, discipline, confidence and leadership and they convey core principles that are important in a democracy, such as tolerance, cooperation and respect. Physical education and Sports teach the fundamental value of effort and how to manage essential steps in life such as victory or defeat. For the individual, sport enhances one's personal abilities, general health and self-knowledge. On the national level, physical education and sports contribute to economic and social growth, improve public health, and bring different communities together. On the global level, if used consistently, physical education and sports can have a long-lasting positive impact on development, public health, peace and the environment.

Moreover, the scientific evidence supporting physical activity's role in health and well-being has been extensively documented, and there is little question that physical education plays an important role in public health because it reaches most children (Pate, Corbin, Simons-Morton, & Ross, 1987; Sallis & McKenzie, 1991). Moreover, because physical activity has been engineered out of most aspects of daily life, the relative contribution of physical education to daily physical activity becomes significant.

Physical education is a life-long process. Every student must continue his or her participation in a developmental program of physical activities, which are healthful, intellectually invigorating, morally uplifting, socially significant, culturally enhancing and environmentally oriented. Physical education as an academic discipline is directed towards understanding people, with particular reference on the ability to move, the ways on how to utilize this ability, and the ways to which this ability is related to other aspects of functioning as a whole person. Thus, movement as a dynamic function of man is the area of central concern that gives physical education its unique identity as an academic discipline (CMO 23, series of 2011).

Therefore, the essence in coming up with quality physical education were based on the following reasons: (1) Regular Physical Activity Helps Prevent Disease; (2) Regular Physical Activity Promotes Lifetime Wellness; (3) Quality Physical Education Can Help Fight Obesity; (4) Quality Physical Education Can Help Promote Lifelong Physical Fitness; (5) Quality Physical Education Provides Unique Opportunities for Activity ; (6) Quality Physical Education Teaches Self-Management and Motor Skills; (7) Physical Activity and Physical Education Promote Learning; (8) Regular Physical Activity Participation Makes Economic Sense;(9) Physical Education Is Widely Endorsed; and (10) Quality Physical Education Helps to Educate the Total Child (Masurier, 2006).

With the earlier cited concepts and ideas, the researchers were motivated to present a report on the level of readiness of selected higher educational institutions to offer the new program, Bachelor of Physical Education major in School Physical Education. The output will serve as a guide for administrators, teachers and students regarding the said program. More so, the evaluation findings are expected to address the problems and deficiencies that need to be complied by the institutions to acquire the full grant of government permit towards implementation of the program.

Statement of the Problem

This study aimed to present a report on the level of readiness of selected higher educational institutions to offer Bachelor of Physical Education major in School Physical Education.

Specifically, this study sought to answer the following questions:

1. How may level of readiness of the selected higher educational institutions in compliance with the policies, standards and guidelines be described based on the areas of administration, faculty, curriculum, library; and physical facilities.
2. How may the selected higher educational institutions be evaluated in terms Commission on Higher Education policies, standards and guidelines (PSG's) for Bachelor in Physical Education?
3. What are the recommendations for compliance to acquire the government permit/recognition to offer the course or program?
4. How may the evaluation report will stimulate the motivation of the stakeholders to collaborate in the promotion, implementation, and assessment of healthy, fit and sporty lifestyle of the selected higher educational institutions?

The purpose and focus of this study was to present an evaluation report on the level of readiness of selected higher educational institutions to offer Bachelor of Physical Education major in School Physical Education. The output will serve as a guide to provide a strong base of knowledge to anyone who wishes to offer the program.

The study was conducted in selected higher educational institutions in Region III while the school administrators, faculty and selected key personnel served as the main respondents. Administrators, faculty and department chairs were the respondents regarding the minimum standards, policies and guidelines for Bachelor in Physical Education. However, comparison of the evaluation of the different group was done. Comments for each group were taken and considered independently in crafting recommendations.

Conceptual Framework

The program has always standards that it follows based on what was prescribed by the accrediting agency. For academic institutions, standards were being provided by accrediting bodies with the Commission on Higher Education for Higher Educational Institution, for Basic Education is the Department of Education while for skills development is the Technical Education and Skills Development These are the authorities who give minimum standards on this trifocal organization which provides the formal education of the Filipino. The Commission on Higher Education provides supervision, approval, monitoring and assessment of the different higher educations in the country both the private and public entities. The policies, standards and guidelines were based on the Commission on Higher Education Memorandum Orders that were forwarded to the different institutions in the country for implementation and guidance.

The study adopts the input – process – output where it explained the flow of the study. The input was the Commission on Higher Education Circular Order (CMO) 23, series of 2011 that explains and discusses the whole standard operating procedure of the Bachelor of

Physical Education major in School in P.E. and Sports and Wellness Management. The focus of the Bachelor in Physical Education program emphasized the specialization on coaching, teaching, training, sports coordinator, event manager, and head of athletics. This is in preparation for the K + 12 programs, totally, the curriculum will change with regards to its content and standards. The process will focus on the evaluators' inspection; evaluation of the higher educational institutions and survey based on the CMO standards series of 2011. A continuous collaborative effort and triumph can be measured through continuous developments push towards meeting the standards of physical education and meeting the excellent performances of sports. The management of the higher educational institutions will give the direction to the school where it will go in the next coming years in the field of physical education. Jensen (1983) said that having clearly stated goals that are both challenging and realistic is of utmost important. Administration without them is similar to going a field trip with no destination in mind and, therefore, no determined route to follow. Socrates expressed it well when he said, "for a ship without destination, no wind is favorable." The output of the study gives a reports on the evaluation results for Bachelor of Physical Education major in School Physical Education of selected Higher Educational Institutions. Recommendations based on CMO. 23 Series of 2011 Standards for selected Higher Educational institutions to attain the quality program for physical education and sports were also presented. Fig 1. Presents the schematic diagram of the study.

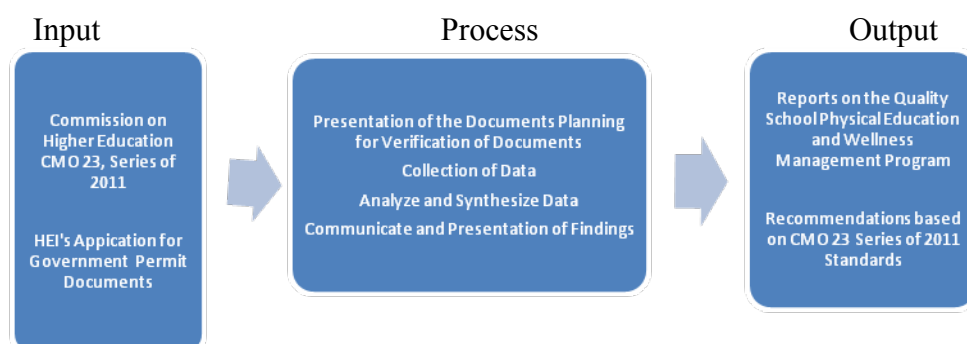

Figure 1. Schematic diagram of the study.

Methods of Research

The methodology employed in the study was a descriptive method. This method primarily concerned with finding out "what is". Borg and Gall (1989) classified the outcomes of this type of research into four categories of description prediction, improvement and explanation. Descriptive research describes the natural or man-made educational phenomena that are of interest to policy makers and educators. This type of research yielded to present rich data of the level of readiness of selected higher educational institutions to offer BPE course and led to important recommendations to acquire the permit to implement the program. The CHED evaluation instrument was utilized to position various inquiry related to policies, standards and guidelines, plan inquiry, collect data, analyze and synthesize the data and communicate or present comprehensive findings considering every details or key areas of the program.

The following were the research instruments utilized by the researcher in ensuring that all the needed data gathered for the study are valid and reliable.

CHED Evaluation Instrument

It is a standardized instrument used to gain information from a subject. These are survey form checks institutions compliance with CHED policies, standards and guidelines in terms of the following key areas: administration, faculty, curriculum, library and physical facilities to offer the Bachelor of Physical Education program.

Documentary Analysis

To support the needed data, a documentary analysis of pertinent materials submitted by the selected higher educational institutions were analyze and evaluated based on CHED Policies, standards and Guidelines to offer the BPE course. Related print materials such as books, journals and periodicals as well as websites and published and unpublished related learning resources were used in the study.

Interview

Interviews with the personalities of selected higher educational institutions were conducted to crosscheck data presented found in the instrument and submitted documents. The interviews made after the collation of the data to deepen the analysis and interpretation of data.

Statistical Treatment of Data

The data gathered were collated based on the responses in the questionnaires. Results were tallied, classified, tabulated, analyzed and interpreted using the appropriate statistical tool. The descriptive statistics was used in order to analyze all the data acquired and obtained. The data were in frequency, percentage and weighted mean. The study was conducted among five (5) selected higher educational institutions in Region III. The main respondents of the study were the administrators, faculty and key personnel of the institutions.

Findings

The evaluative report presented was an actual verification on the visitations conducted by the regional quality assurance team and deficiencies were submitted after the initial findings and later feed backs from the CHED central office was faxed in the school. Based on the strengths and weaknesses, the following items were identified as in non – compliance based on the CMO 23.

Non-Compliance Report

Program Head. Not complied with.

The findings stated that the status of the program head was not indicated whether part-time or full time and contract was indefinite. The question was, how can the program head provide leadership in the department if that will be the case?

The policies that were created in each educational institution vary in terms of hiring, recruitment and tenure of service. There were situations that faculty were given a terminal contract and it will depend on them to continue their service or they will not be rehired based on the performance evaluation through the recommendation of the dean. One of the qualities of a program head must be physically educated person and has learned skills necessary to perform a variety of physical activities; is physically fit; does participate regularly in physical activity; knows implications of and benefits from involvement in physical activities; and values physical activity and its contributions to a healthful lifestyle. (National Association for Sport and Physical Education, AAHPERD, 1992).

Faculty: Not complied with.

There were 4 faculty who will teach in the degree program but only the application letter, résumé's and other documents were submitted but the certificate of appointment were not submitted either part-time or fulltime basis. But on the competencies of the faculty who intended to apply were all qualified based on the standards.

Library Holdings: Not fully complied with.

The books that were purchased were not sufficient because of the high costs of the books. Most of the books that were purchased were foreign and some are Filipino authors. Imported books cannot just order in the publishing companies but it will take months to be delivered. The required books were insufficient since the books were not just found in a book store like JOPERD and McMillan. It needs to be ordered in different book suppliers. Apparently, books serve as sources of knowledge and information for the students to seek their deeper knowledge, understanding and comprehension. This is in conformity with the passage of Dr. Seuss that, "the more you read, the more things you will know. The more that you learn the more places you'll go."

Laboratory Equipment/Facilities: Not complied with.

In some institutions, a plan of building up gymnasium for the general use of the students in their physical education and sports activities were highlighted. Unfortunately, in some, construction was not yet started when the time lapses with the given time of completion on the deficiencies by the CHED office. The plans and the proposals were submitted for alternatives based on the standards and marketing of the school for business purposes. In the history of academy or lyceum, gymnasium became the physical, intellectual, social and moral centers of Greeks (Bucher and Wuest, 1999). Nowadays, classic gymnasium class – physical education focuses on the body and the brain. Gymnasium is the setting for fitness activities and sports (Rahn, 2011).

The laboratories required for the course is comprehensive, like for the following: Biomechanics laboratory is to gain a better understanding of the cause and effect mechanisms of sports motions. The lab is equipped mainly for film analysis. The Human Performance Laboratory conducts both basic and applied research in sports medicine and biomechanics, using metabolic carts, treadmills, bike ergo meters, motion analysis systems, and other pertinent equipment software (www.indiana.edu/~kines/facilities/index.shtml). And the Sports Medicine House serves its purpose to prepare athletes/students to gain strength for athletic competitions, rehabilitate and recovery station for injured athletes. The facilities were managed by licensed athletic trainers or Physical Therapist with expertise on exercise physiology. Other therapist helps in the rehabilitation program by giving therapy session (Miller, 2012). Below was the suggested/recommended structure of the gymnasium based on the land area.

The attainment of goals varies on the leadership and management ability. The will to attain objectives may consider tough but as long as the positive energy, teamwork, and hard work will stay together, there is no possible that it cannot be achieved no matter how hard the tasks. It was emphasized that though it was a challenge to come up with an approach how to get the support of departments especially the management, it is good to present something and let them realize the inputs of the employees as they contribute in the attainment of the school's aspiration towards progress and development. It was a challenge on my part of some institutions of not achieving the goal in securing government permit for the Bachelor of Physical Education program but it takes years for better planning and preparation rather than not to achieve something because of immediate decision without enough preparation for some. The institutions, through its President, filed its application for government permit to

offer the Bachelor of Physical Education Major in Sports and Wellness Management to the Commission on Higher Education for evaluation.

Discussion

Program Administration

Dean/Director/Department Head – Not fully complied with. It was identified that the designated program head were not able to meet the minimum requirements to handle the position. A Dean/Director/Department Head shall be employed and assigned on full-time basis to provide leadership and direction to the physical education institute/college of the school and who shall have the following qualifications:

- In the attached documents it is not specified the status of appointment whether full-time or part time

Faculty: Not complied with. There were four (4) faculty assign to teach Physical Education. As per compliance, no attach document for the certificate of appointment (full-time/part-time) and certificate of licensure examination for teachers (LET). As stated in the policies , standards and guidelines of the Commission on Higher Education the following are the qualification of the faculty teaching the professional courses in Sports and Wellness Management. For the General Education and Major Courses – 100% of the full-time faculty and a minimum of 50% of the part-time faculty have Master’s degree in the discipline they are assigned to teach. The faculty must be a holder of at least Master’s Degree in Physical Education to teach the courses at the Sports and Wellness Management. The faculty must have at least three years of professional work experience in Sports and Wellness Management. Other lecturers such as sports specialist, sports and wellness managers, professional relevant to course offerings may teach.

For faculty development, institutions have a planned and focused on five (5) areas: scholarship, faculty research, seminars and trainings, collaborations and linkages and exposures through educational trips and benchmarking. The institution must have a system to support faculty development (complete doctoral degrees in education and other allied fields; attend fields; attend continuing education seminars, workshops, and conferences; undertake research activities related to teacher education and give lectures and present papers in national/international conferences, symposia and seminars.

Curriculum: Complied with. As per Commission on Higher Education’s policies, standards and guidelines, the General Education Courses must have 63 units while the Professional Education Courses has to complete Professional Courses (51 units) and Major Courses (60) units respectively. The Bachelor of Physical Education major in School Physical education (BPE-SPE) curriculum should consists of General Education (63 units), Professional Education Courses (51 units), Theory/Concept Courses (12 units), Methods/Strategies Courses (24 units), Field Study 1-6(6 units), Practice Teaching (6 units), Special Topics (3 units) and Major Courses (60 units) with a total of 174 units. On the other hand, Bachelor of Physical Education major in Sports and Wellness Management (BPE-SWM) must obtained a General Education (63 units),Core Courses(27 units, Professional Courses(51 units),Elective (9 units) and Practicum of (6 units) with the total of 166 units.

Library: Complied with. The librarian of each institution was holder of Master of Library and Information Science and a licensed librarian. The head librarian must be a holder of Master in Library and Information Science degree with a valid license and serving in a full-time basis. For library holdings/facilities, the list of books for professional education is not sufficient for the program applied for. Must provide five (5) non-duplicated book titles per course found in the curriculum and must have published within the last five (5) years. Must have at least

3,000 total number of accessioned books for initial permit and 5,000 for government recognition. The higher educational institutions were required to subscribe to at least two (2) peer reviewed or refereed journals and periodicals in Physical Education and allied programs that are published locally and internationally. The subscriptions may be for hard or electronic copies of journal. Must provide at least 100 audio-visual materials in the forms of tapes, films, records, CDs and DVDs. Fifty percent of the collections should have been published/produced within ten (10) years. Must provide Internet access to faculty members and students for research and other academic activities. The library may provide access to electronic library materials such as CD-ROMS. These are considered as additional library holdings beyond the minimum requirements. For Laboratory Equipment/Facilities was identified to be of non-compliance.

School site/building: Complied with. The site was owned or leased. If leased there are at least 10-year lease contract and the total/floor area of at least 1,000 square meters. Laboratory Requirements – Not fully complied. For programs offering specializations in the science and technology fields, the appropriate laboratory facilities specified in the course specifications should be complied with.

Educational Technology Laboratory Requirements – Complied with. As per actual verification there are available theater. In addition to the required laboratories and facilities for general education, the following shall be provided:

- Lecture classroom: Not complied with. As per actual verification there is a need to construct Gymnasium and other Sports facilities and fitness laboratory in some institutions.
- Specialized laboratories for physical fitness and testing;
- Information and communication Technology facilities and equipment;
- First – aid stations
- Open space for play area
- Emergency and Disaster System is required. In the absence of any of the above-mentioned facilities, the institution shall enter into an agreement with the other institutions/agencies.

Admission Requirement: Complied with. As per CHED compliance, the institution has selective admission and retention of students to ensure that those who enter the physical education teaching and sports wellness management. Must have a system of selective admission and retention of students to insure that those who enter the physical education teaching and sports and wellness management professions possess a reasonably high level of scholastic achievement and the appropriate aptitudes, interest, and personality traits. There shall be well-defined criteria for admission into the programs.

Conclusion

In view of the above observations/findings deficiencies noted, relative to the documentary compliance submitted, the application for permit to offer the Bachelor of Physical Education major in School Physical Education and Sports and Wellness Management program cannot be granted for some institutions due to non-compliance with the said deficiencies.

A more intensified leadership and management abilities should transpire in order to meet the goals of such endeavor. There should be closer collaboration of the stakeholders in planning, implementing, monitoring, and evaluation of each program as well as a thorough knowledge. NASPE,2014 emphasized that continuous awareness on the characteristics and importance of quality Physical Education was significant. It should provide an opportunity to learn for all students. There should be an instructional period totaling 150 minutes/week

(elementary) and 225 minutes/week (middle and secondary school). There must be a qualified physical education specialist providing a developmentally appropriate program and adequate equipment and facilities for students need. Must have a meaningful content in which instructions in a variety of motor skills are designed to enhance the physical, mental, and social/emotional development of every learner. Fitness education and assessment should be provided to help children understand improve and/or maintain their physical well-being. Development of cognitive domain about motor skill and fitness should also be given emphasis. It should also provide opportunities to improve the emerging social and cooperative skills and gain a multicultural perspective that will contribute in the promotion of regular amounts of appropriate physical activity now and throughout life. Physical Education should further provide an avenue for appropriate instruction that will give an atmosphere of full inclusion of all students, maximum practice opportunities for class activities, well-designed lessons that facilitate student learning, out-of-school assignments that support learning and practice, no physical activity for punishment and use of regular assessment to monitor and reinforce student learning.

References

- Bucher, C & Wuest D. (1999). *Foundation of Physical Education and Sports*. New York: McMillan.
- Dale, D., & Corbin, C. B. (2000). Physical activity participation of high school graduates following exposure to conceptual or traditional physical education. *Research Quarterly for Exercise and Sport*, 71(1), 61-68.
- Dishman, R. K., Motl, R. W., Saunders, R., Felton, G., Ward, & D. S., Dowda, M. (2004). Self-efficacy partially mediates the effect of a school-based physical-activity intervention among adolescent girls. *Preventive Medicine*, 38(5), 628-636.
- ICHPER.SD Asia Region. (2000a). Guidelines for the Development of the Sport Industry in Asia. Kuala Lumpur.
- Malaysian Association for Physical Education Sport, Science and Fitness (PPJSKM).
- International Olympic Committee. (1990). Sport for All and the International Olympic Committee. Geneva: International Olympic Committee.
- Jensen, A. (1983). *Administration of Physical Education*. New York: Mcmillan.
- Kroll, W. P. (1971). *Perspective in Physical Education*. New York: Academic Press.
- Masurier, G. L., Assistant Professor of Kinesiology at Pennsylvania State University, University Park.
- McKenzie, T. L., Sallis, J. F., Prochaska, J. J., Conway, T. L., Marshall, S. J., & Rosengard, P. (2004). Evaluation of a two-year middle- school physical education intervention. *M-SPAN. Medicine & Science in Sports & Exercise*, 36(8), 1382-1388.
- Pate, R. R., Corbin, C. B., Simons-Morton, B. G., & Ross, J. G. (1987). Physical education and its role in school health promotion. *Journal of School Health*, 57(10), 445-450.
- Prusak, K. A., Treasure, D. C., Darst, P. W., & Pangrazi, R. P. (2004). The effects of choice on the motivation of adolescent girls in physical education. *Journal of Teaching in Physical Education*, 23, 19-29.
- Sallis, J. F., McKenzie, T. L., Alcaraz, J. E., Kolody, B., Faucette, N., & Hovell, M. F. (1997). The effects of a 2-year physical education program (SPARK) on physical activity and fitness in elementary school students. *American Journal of Public Health*, 87(8), 1328-1334.
- Sallis, J. F., & McKenzie, T. L. (1991). Physical education's role in public health. *Research Quarterly for Exercise and Sport*, 62(2), 124-137.
- Shaeffer, Sheldon. (2008). Director, UNESCO Bangkok, Asia and Pacific Regional Bureau of Education.
- Trudeau, F., Laurencelle, L., Trembley, J., Rajic, M., & Shephard, R. J. (1998). A long-term follow-up of participants in the Trois-Rivieres semi-longitudinal study of growth and development. *Pediatric Exercise Science*, 10, 366-377.
- Trudeau, F., & Shephard, R. J. (2005). Contribution of school programmes to physical activity levels and attitudes in children and adults. *Sports Medicine*, 35(2), 89-105.

Integrating Technology in the ESP Classroom in the Department of Biology- Tlemcen University (Algeria)

Faiza Haddam Bouabdallah
University of Tlemcen – Algeria
Department of English

Abstract

Since the mid-20th century, English has become the *lingua franca* for scientific research; technical English terms have been integrated into many languages. ICT and web access are considered as an open window into the world to acquire these terminologies. They also offer some truly unique opportunities that can give teaching new impetus and create quite a lot of fun for the students. Learners can quickly improve specific target vocabulary through various techniques. Most importantly, ESP (English for Specific Purposes) students get a feel for how English is used in their specific field of research. Scientific English instruction at Tlemcen University Department of Biology celebrates its 25th year. Most study courses require students to read and to translate scientific texts in English since they are expected to use recent articles and to attend international conferences. By using these recent techniques (i.e. internet and ICT) in the lessons, one can give students "real world" English in their specific field, and overstep their lacks deficiency in the target situation. One will also pick up quite a lot of useful materials that can be used in future lessons. This paper explores difficulties encountered by biology students mainly in listening and speaking skills and the benefits of using technology to reinforce the existing practice in teaching and learning ESP. This urges students to be more autonomous in the future and create an amalgam with the traditional methods.

Keywords: ESP Classroom - Technology (ICT) - Listening and speaking skills

Introduction

English has gradually achieved its significant identity as the world language during the globalization process. As the economy in the globalization process has engendered new knowledge, some problems have arisen, such as transferability from academic to professional contexts. Considerable research in second and foreign languages has shown that individual adult learners have different needs and learn English for different reasons. The teaching of a language should, thus, be carefully prepared to fit students' specific needs and purposes (Nelson, 2006). English for Specific Purposes (ESP) has become one of the most popular scholarly topics over the last decade, but has so far received less attention from researchers than it deserves. English for Specific Purposes implies meticulous research undertaken to produce pedagogically suitable materials and exercises for most adult learners defined in a specific context (Johns & Dudley-Evans, 1991). The main issues that hinder the teaching and learning process in the department of biology are:

- Biology students face difficulties in speaking and listening skills mainly.
- There is a lack of useful materials (ICT and Web access)
- Time allocated to English sessions is insufficient
- Students' level in English is poor

This paper explores the difficulties facing biology students, mainly in listening and speaking skills and the benefits of using technology to reinforce the existing practice in teaching and learning ESP. This will hopefully develop students' autonomy in the future and create an amalgam with traditional methods.

Research Methodology

This research work is divided into three parts: the first step describes the state of the art in the Department of Biology at the University of Tlemcen (the present teaching/ learning situation); the second part analyses students' needs through a questionnaire and the last part tests students before and after implementing ICT in the classroom and an interview to get students feedback at the end of the semester.

The sample population is First-Year Master's Students in the Department of Biology, Faculty of Sciences. The present study aims at introducing recent techniques (i.e. internet and ICT) in future lessons by teaching students « real world » English in their specific field. This helps them overstep their lacks deficiency in the target situation and reinforce the existing practice in teaching/learning ESP in order to become more autonomous.

Description of the teaching/learning situation at the Department of Biology

Today, the teaching of ESP is gaining popularity throughout the world. Algeria also stresses on the importance of English in the educational system in general and higher education in particular. Among other national institutions, the University of Tlemcen offers English courses to equip students in terms of specific needs. The university hosts several Faculties amongst which the Faculty of Sciences where students in the Department of Biology take English as a compulsory subject for both licence and master studies. Despite the growing demand for ESP instruction within Algerian Universities, ESP courses in the Department of Biology are still limited to learning specific lexicon and translating texts through reading scientific and technical articles. A method which fundamentally ignores the learners' personal interests and needs and leads to low motivation in their English studies and, in turn, low performance later when they use the language in their future profession. So the main problematic in that Department is the absence of an adequate ESP course and materials that suit the students' needs for using English in specific situations. Other issues are the shortage

of language teachers in general and ESP teachers in particular and low or no internet access facilities.

Course content

In this department, students are taught Reading Comprehension through different scientific articles in the target language. Here, the students are expected to be able to comprehend the reading materials and understand the meaning of the text, and to grasp the different technical words used in the article. As a second step, the lecturer teaches the students how to translate articles from English into French in order to use them as updated resources for their future scientific research. Unfortunately, no lecturer tries to include tasks that involve communicative skills within the sessions.

The timing that is set for the English module in that Department is not sufficient to reach the appropriate objectives. At the Department of Biology, the English module is introduced officially within the curriculum during the first three years of study within the LMD System, where only one hour and half per week are devoted to this module from first to sixth semester. Then, two hours weekly during the first and second semester at Master level. The present course content in that Department is summarised in the table below although terminology and translation are the main contents of the English courses, there is no variety of lessons and activities to make them practice the four skills in integration.

Course Content	Number of Sessions	Percentage
Terminology & Translation	25	65.5%
Vocabulary & Grammar	5	12.5%
Listening & Speaking	0	0%
Reading & Writing	0	0%
Other*	10	25%
* Total absence of English sessions		

Table 1: Present Course Contents

Needs Analysis

Identifying students’ needs is considered as the starting point for ESP teaching and understanding of how and why adult students learn since learning and teaching are determined by the learners themselves. As shown in the following graph, most participants claimed that reading, translating scientific articles and understanding lectures on biology in English are their reasons for studying English. Taking part in oral discussions (with 28%) is also an important skill to acquire. Whereas, taking exams (16%) is considered as a second step for them

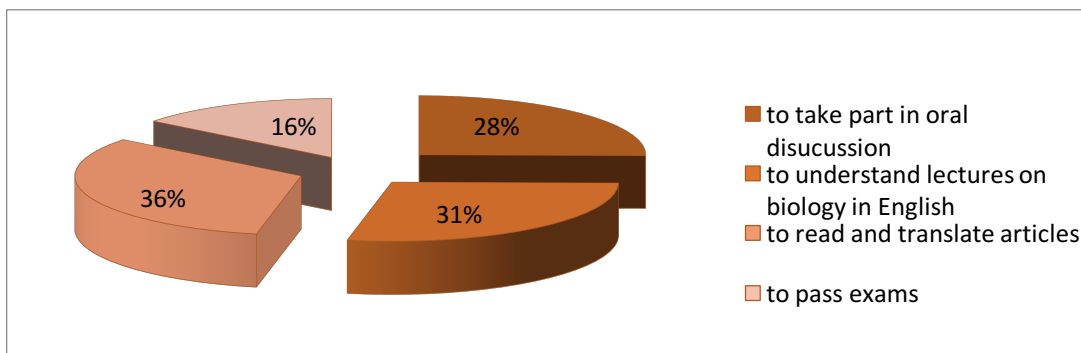

Pie chart1: Reasons for studying English

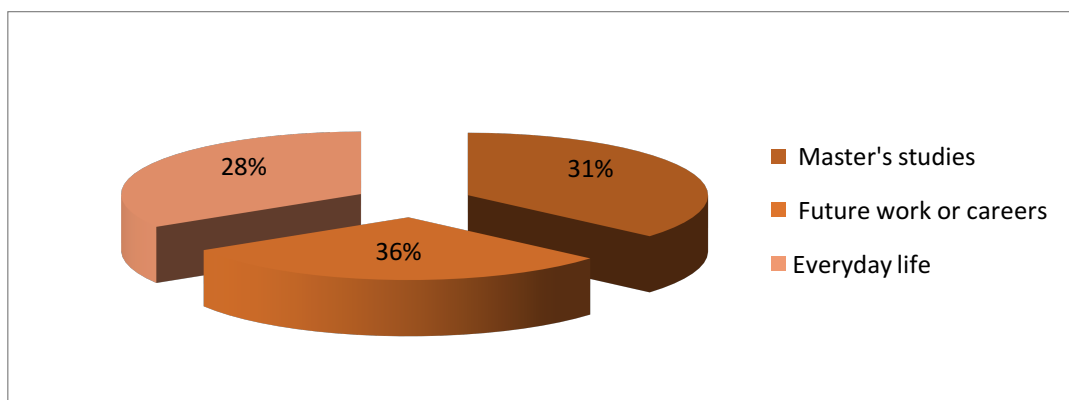

Pie chart 2: Students' Specific Needs in English

As shown in graph 2, the informants consider English as a prominent language to take into consideration as their target needs for their future life. 36% of students need English in their Master's studies, 31% for their future work or careers and 28% need English in everyday situations. These results show the great impact of the English language on Master's students.

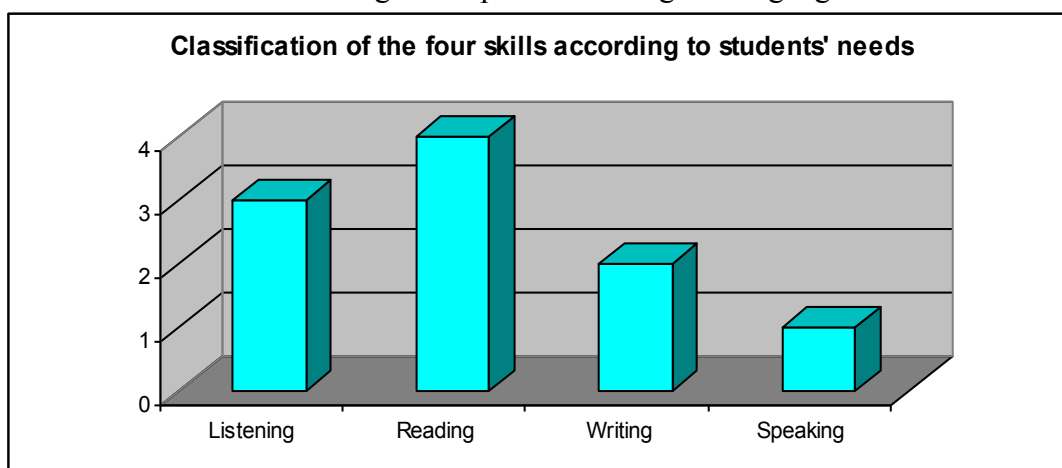

Bar Graph 1: Students' Needs in the Language Skills

In Graph 1, students have classified the four skills according to their needs and the results rightly illustrate the previous results, where they are asked to evaluate their levels in the four skills. The reading and listening skills are their top priorities for improvement. However, the writing and speaking skills are rated at lower levels.

In this section, a multiple-choice question was asked to identify students' deficiencies in the English language. The results are shown in the following table:

Students' difficulties in the EFL		
Options	Number of informants	Percentage
Communication	34	85%
Speaking	26	65%
Grammar	24	60%
Pronunciation	20	50%
Vocabulary	19	47.5%
Listening	18	45%
Writing	9	22.5%
Reading	9	22.5%

Table 2: Students' Weaknesses in the English Language

The results show the negative attitudes of students towards their English competence in speaking. The great majority of the informants (85%) feel that they have difficulties in expressing themselves orally in English; grammar and pronunciation are also considered by students as a major failing with 60% and 50% respectively. 47.5% of the students admit that they do not have adequate and enough vocabulary in English; however, 22.5% consider writing and reading as the skills they master most. .

This research evolves around two main skills which the students' need, mainly speaking and listening, to propose the necessary materials adapted to their needs and objectives. The results obtained from the collected data are summarised in the following tables:

Responses to the First Two Levels of Importance*			
Speaking Skills	Item No	Count	Percentage
Taking part in conferences	14	30	75%
Giving oral presentations	15	27	67.50%
Asking questions in class	16	26	65%
Speaking to English foreign colleagues	17	22	55%
Speaking to English foreign visitors	18	18	45%
Short talks	19	16	40%

*Two Levels of Importance are "Very Important" (VI) and "Moderately Important"(MI)

Table 3: Rank Order of Six Items of Speaking Skills

Responses to the First Two Levels of Importance*			
Listening Skills	Item No	Count	Percentage
Listening to teacher talk	23	27	67.50%
Following oral questions/answers	21	22	55%
Listening to spoken presentations	22	21	52.50%
Following lectures	20	17	42.50%
*Two Levels of Importance are “Very Important” (VI) and “Moderately Important”(MI)			

Table 4: Rank Order of four Items of Listening Skills

Tables 3&4 present the ranking order of four items of perceived language skills mainly speaking and listening according to the percentages of the students’ frequency responses to combined categories of “Very Important” and “Moderately Important”. As can be seen from Table 3, taking part in conferences (75%), giving an oral presentation (67.5%) and simply asking questions in class with 65% seem to be perceived as most important among these four items of English-language skill needs in the research questionnaire. However, the frequency data shows that these biologist informants consider the listening activities as important with a great emphasis on being able to follow lectures in English with very high percentages of students’ responses (67.5%).

INTEGRATING ICT TO ENHANCE STUDENTS’ LEVEL IN LISTENING AND SPEAKING

The analysis of learning needs of the target learners leads to the adoption of several principles in the writing process of the course materials. First, the course should be based on authentic materials and should be made interesting at the same time. Second, it should motivate learners to take an active role in the language learning process. Third, it should help learners improve their communication skills. Finally, the course should make learners feel secure when practising listening and speaking integrated with writing and reading. Making use of results analysis of the collected data obtained from informants in this research, some concrete and practical suggestions for reforming the existing course in the Department of Biology and classroom teaching practices are proposed; as pointed out by Hutchinson and Waters (1999), “If learners and teachers know why the learners need English, that awareness will have an impact on the content of the course and on the positive side, what potential can be exploited” (p. 53). One of these suggestions is integrating ICT during the lectures such as data show, language laboratory and use of online courses. By integrating technology, the methodology and the content of the courses should turn around different activities to enhance students’ level in speaking and listening and to encourage students to communicate in class. As pointed out by all respondents in this study, the integration of audio-visual materials is of paramount importance to fulfill their needs mainly in speaking and listening skills. As already suggested, the frequent use of power point presentations as well as the use of language laboratory might increase their interest and motivation in learning a language. The students will feel more confident and at ease during the sessions. Each activity is used for different reasons but to fulfill the same and one common objective is to encourage students to communicate in class. Some of these activities are presented below:

- Power point presentation: The students are asked to prepare a project on a specific scientific subject. The aim is to make them aware of how to present scientific research in English orally by using technology.

- Pair or group work activities: Different students with different levels in English are put together to achieve a given exercise. The aim is to help students with a poor level in English to feel more confident during the sessions.

- Data show projection: Displaying drawings and figures taken from various scientific courses on the data show instead of using long articles in handouts is done on purpose. It is used to define concept or object from a non-verbal presentation, a procedure that Widdowson (1987) calls 'information transfer'. Information transfer develops comprehension and interpreting when it is oriented from non-verbal to verbal mode and vice versa.

However, using audio-visual aids also includes maps, tables, various types of charts, pictures and photographs of objects, apparatus, etc. They could be a motivating and productive strategy in ESP context. These are especially useful when teaching EST because they constitute some of the most typical means of presenting and organizing information in written scientific discourse. This new methodology in organizing English courses in this department could not be possible and fruitful for students without additional sessions weekly. Thus, the lack of time described earlier, was resolved for the achievement of this research.

Students' Feedback

When proposing a new methodology for ESP course content, the first step is to analyze the target situation to define the problematic. The second step deals with the analysis of learners' specific needs to point out their wants, necessities and lacks. The last step is the analysis of students' feedback through an interview at the end of the semester to find out how they felt about the different aspects of the course, especially its efficiency and relevance and finally, its advantages and drawbacks.

Results' analysis: This is the last but not the least important section of this survey. In this final open evaluation question, the researcher tried to examine different aspects that are not specified in this survey in order to give students the opportunity to express their ideas and feelings regarding the course and find out if all subjects were fruitful and interesting. Therefore, some advantages and drawbacks proposed by students are presented below:

Advantages:

- Exposing the learner to listening activities using as many authentic materials as possible
- To develop good listening skills
- To encourage students to speak with a correct pronunciation
- To help students learn more through attention and concentration during the sessions
- To help the shy learners get more benefits
- To establish an atmosphere of motivation and security

Drawbacks:

- The lack of competency in using such a system both by the teacher and the students (or NOT familiar with the computing technology)
- Lack of training in using technology
- According to them, it's not the only way to get proficiency in English
- Inability to handle unexpected situations
- Time consuming to coordinate between the proposed program and technology
- Frequent problem of power and web access

Concluding remarks: Computer-based activities are becoming important in our university. This popularity does not come from a vacuum; on the contrary, it has solid foundation in all

areas where the computer is used. In terms of language teaching and learning, computer use in the classroom has more advantages than drawbacks. It helps teachers and learners to quickly access documents addressing individual student's needs, thereby improving motivation and effectiveness.

Conclusion

Designing a course for particular students in specific situations is a very difficult task and time demanding. The course designer has to organize courses and activities according to the students' needs and interests but due to the lack of materials for ESP courses, she/he is expected to plan her courses well and to provide adapted materials when published ones are unsuitable. With reference to a particular classroom experience, the design of the course should be prepared. The levels of attainment are described by Kaosar Ahmed (2014) for each skill area as follows:

1. Survival Level – The person can use language for basic purposes in extremely limited way.
2. The way stage level – The person can communicate very simply in limited range of topics.
3. The Threshold level – The person can use the language for most everyday situations and topics at simple level.
4. The adequacy Level – The person can use the language for range of situations and topics and can show awareness of appropriate style and variety.
5. Proficiency Level – The person can respond flexibly to complex ideas and expressions.
6. The mastery Level – The person has no problem in using the language.
7. The ambi-lingual Level – The person's use of language is indistinguishable from that of any educated native speaker (p. 42)

An ESP teacher carrying out a needs analysis, designing a course, or writing teaching materials needs to be capable of incorporating the findings of the research and be confident that they know what is involved in terms of skills. The teacher should focus on the learners' interaction 'student-centered approach' (Hutchinson & Waters, 1987) rather than overwhelm the course with exhaustive list of words and boring grammar exercises. In ESP settings, most students come to courses with mixed-abilities which is why teachers should employ a variety of teaching methods and assessment techniques based on students' capacity and learning styles. Consequently, they have to make use of modern technologies in class or other traditional audio-visual aids to meet the learners' needs and to motivate them. Technology has long played a major role in the teaching of English for Specific Purposes. It has been used to create context mainly for listening and communication, and it is also used to motivate the learners in acquiring a language in a specific context.

References

- Abu-Zahra, M. J. & Sahayeb, A. S. (2011). Is ESP a needs? Retrieved from the web: <http://www.Gov.Edu.English/Conferences/firstnationalconference>.
- Barnard, R. & Zemach, D. (2003). Materials for specific purposes in B. Tomlinson (Ed.) *Developing Materials for Language Teaching*. London: Continuum
- Dudley-Evans, T. & St John, M. J. (1998). *Developments in English for Specific - Purposes*. Cambridge: Cambridge University Press
- Dudley-Evans, T. (2001). Foreword. In S. Benesch, *Critical English for Academic Purposes: Theory, Politics, and Practice* (pp. ix – xiii). Available from www.questia.com
- Graves, K. (1996). *Teachers as course developers*. Cambridge: Cambridge University Press
- Graves, K. (2000). *Designing Language Course: A Guide for teachers*. Boston: Heinle and Heinle.
- Kaosar, M. (2014). The ESP Teacher: Issues, Tasks and Challenges. *English for Specific Purposes World*, 15(42)
- Nelson, M. (2006). Semantic associations in Business English: A corpus-based analysis. *English for Specific Purposes*, 25, 217-234.

Perceived Status of the Filipino Film Industry: Implications for Media Education

Isolde E. Valera

De La Salle Univeristy - Dasmariñas Cavite, Philippines
Communication and Journalism Department

Abstract

Media use is seen as a very important part of Filipino life as exposure to media mirrors the desire to be part of both society and environment. Yet, despite claims of some critics that Philippine cinema is dying, this study determined the perception of communication educators on the status of the Filipino film industry and its implications for media education. The study determined the technical, artistic, business, and social responsibility aspects of the Filipino film industry. The study utilized the descriptive normative survey method to describe and interpret the current condition of Filipino film industry. Results of this study revealed that a majority of the respondents have less exposure to film from both mainstream and indie or independent cinema. Educators put the highest premium on the aspects of story concept or screenplay which were followed by cinematography and casting. The artistic and business aspects received good status but very evident is the dissatisfaction of the educators in terms of screenplay. Educators suggest better story concepts for films and more trainings for those who will constitute the backbone of the industry. Educators believe that the industry has inadequately skilled movie workers which represent the major problem of the industry. In order to address the issues, Cavite Communication Educators proposed solutions to the pressing problems of the industry such as patronizing Filipino films and more trainings or seminars for movie workers.

Keywords: Media, Media Education, Film Industry, Film

Introduction

The development of media marks society's growth and improvement. It projects connection to the realities of society and mirrors the experiences of people. The power of media may never be questioned as literature and research prove that exposure to media can influence perspectives and decisions.

Out of 18,539,769 total households in the Philippines, an average household size of 4.76 persons have an average TV penetration rate of 96.21% while newspapers have 63.45. Statistics show that people today spend more time with media with 24.30% for magazines, 71.47% for radio, and 33.09% for the Internet. Meanwhile, 68.72% of Filipino moviegoers are from classes D and E. Watching movies reached a low mark of 5 from 9 in 2007, with 71% of Filipino audiences going to movie theaters less than once a month (The Media Fact book, 2012-2013).

Films provide an escape from realities (Griffin, 2013). Still, these are social mirrors as they provide a media landscape where values and culture may be used for critical thinking. Movies recreate the experiences of others and even one's own struggles as an individual.

The downfall of Philippine cinema is traced from Filipinos' exposure to foreign films rather than mainstream cinema. In addition, the number of films produced over the years has decreased from 140 to 73 or fewer movies in the 2000s. The competition from foreign films with better editing techniques, cinematography, story concept and far bigger production made it difficult for Filipino films to compete. Also, high taxation for film producers affects the number of films available. Hence, with the advent of new technologies and new media platforms, the industry is faced with new challenges.

New competitors come and go, from DVDs to cable TV and free TV. With several movie downloading sites, YouTube channels, and social networking sites, it became harder for the film industry to regain its glory. Over the years, 80% of moviegoers from class C and D have a high preference for drama, romance, comedy, and action. About 70% are 15 – 29 years old (The Media Fact book, 2012-2013).

Determining the status of Philippine Cinema therefore provides a better understanding on how this perceived status reflects media education techniques. Media education refers to the process of developing an informed and critical understanding of the nature of the mass media, the techniques used by them, and the effects of these techniques (Owens & Hunt, 1985).

Production and technical aspects of Philippine movies signify the state of the film industry because the perceived status of the industry has implications for media education techniques that educators may use in the classroom. Media education helps students develop an informed critical understanding of the nature of mass media work, how they produce meanings, how they are organized, and how they go about constructing reality (Media Education: A Teaching Manual, 1995).

This research endeavor primarily focused on the perceived status of Cavite Communication Educators, the home of the Cavite Filmmakers Association which is a newly accredited group by the National Commission for the Culture and Arts (NCCA) launched in December 2014.

The endeavor sought to find answers to the following questions:

1. What is the profile of Cavite Communication Educators in terms of:
 - a) age
 - b) sex
 - c) educational attainment
 - d) numbers of years teaching

- e) media practice
- 2. What is the exposure level of respondents to Filipino films?
- 3. What is the status of Filipino film industry in terms of
 - a) Technical b) Artistic c) Business d) Social Responsibility
- 4. What are the problems confronting the film industry?
- 5. What are the proposed solutions to the problems of the industry?
- 6. What are the implications of perceived status to media education?

Theoretical /Conceptual Framework

The framework reflects the communication educators’ perceived status of the industry. Those educators with negative perceptions have a direct effect on the use of media education techniques. However, those educators with positive perceptions have a strong predisposition to use media education techniques. Whatever is the perceived status, an impact on the usage and preferences of various media education techniques is expected.

The framework notes that the perception of communication educators on the Filipino film industry is divided into four aspects: artistic, technical, business, and social responsibility. Each category comes with factors or measures anchored from Hall who stated that audiences do not just view media messages or media products but audiences become engaged in the process of interpreting such depending on experiences, values, and cultural background. Audiences with similar backgrounds may have a common interpretation (Baran, 1995).

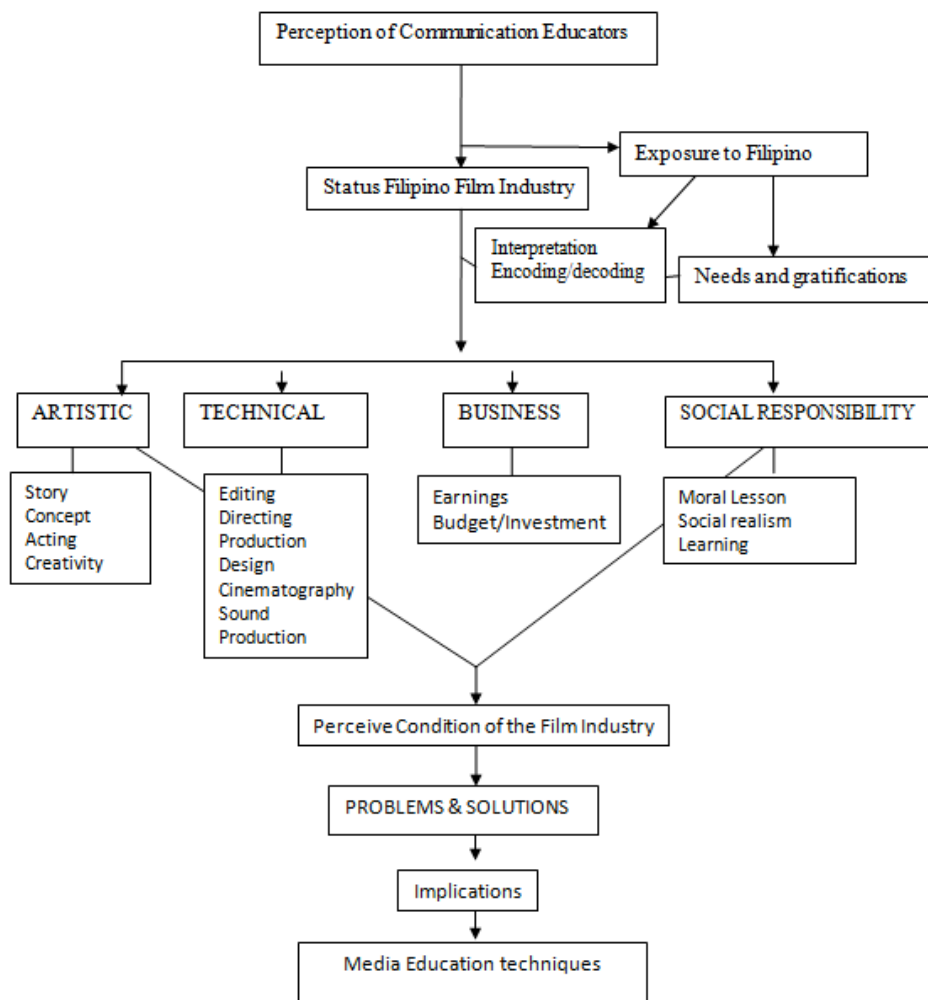

Figure 1. Theoretical/Conceptual Framework

In the encoding and decoding process of Reception theory, communication educators interpret messages from experiences in watching Filipino films. Based on their exposure and experience, a process of interpretation on the status of the film industry was utilized which created a corresponding impact on the media education techniques used in the classroom.

This research is anchored on the uses and gratifications theory of Katz. This perspective is a challenge to communication educators who tend to amplify the thought that individuals use media differently depending on their particular needs and gratifications (Griffin, 2013). In the same light, the exposure of Cavite communication educators to Filipino films may influence the perception on the status of the industry and the media education techniques used in the classroom.

Method

This study used a descriptive survey method to determine the present condition of the Filipino Film Industry. It combined quantitative and qualitative approaches to interpret the current state of the industry. Five schools offering communication programs were selected with a total of 40 full-time and part-time educators from the province of Cavite, Philippines. Key informants are from the following academic institutions: Cavite State University, De La Salle University-Dasmariñas, Emilio Aguinaldo College, Perpetual Help University-Molino, and San Sebastian College-Cavite City.

In-depth interviews were conducted with practitioners to validate results and to provide insights on the current condition of the industry based on their experiences. Focus interviews were also utilized to determine the views of some educators in the use of media education techniques and determine the extent of usage for such.

A survey questionnaire was used as data gathering tool for this study. It was divided into six parts: Profile of the Respondents, Exposure to Filipino Films, Status/Condition of Filipino Film Industry, Problems of Filipino film Industry, and Implications to Media Education. An open-ended part was included for insights on the variables of the study.

The units of analysis refer to the key informants or participants in the interview. They qualify as key informants if they have been teaching for more than 10 years and with industry practice. The respondents of the study are those who have been teaching from the identified institution offering Communication programs and are teaching major subjects that are not necessarily film subjects.

Results and Discussion

An inquiry was made on the profile of the respondents with respect to school, age, sex, educational qualifications, number of years teaching, and number of years experience in mass communication industry or related fields.

PERCEIVED STATUS OF THE FILIPINO FILM INDUSTRY

School	Fulltime/ Part Time	Respondents	Male	Female
Cavite State University	11	11	0	11
De La Salle University-Dasmariñas	16	15	6	7
Emilio Aguinaldo College	6	5	2	3
Perpetual Help University-Molino	4	4	2	2
San Sebastian College-Cavite City	5	5	4	3
TOTAL	42	40	14	26

Table 1
Profile of Respondents

Five (5) schools are represented in the study with majority of full time and part time faculty members participated from the selected schools namely Cavite State University, De La Salle University-Dasmariñas, Emilio Aguinaldo College, Perpetual Help University-Molino and San Sebastian College-Cavite City.

Age Bracket	Total	Years of Teaching Experience	Total
20-30	18	Below 1 year	5
31-40	7	3-5 yrs	16
41-50	10	6-10 yrs	10
51-60	3	11-15 yrs	12
61 up	2	16-20 yrs	4
		21yrs up	3
Total	40		

Table 2.
Age bracket and tenure of respondents

Years of Media Practice	Total
3-5	8
6-10	3
11-15	3
16-20	1
21 up	3
Total	18

Table 3
Years of Media Practice

It is determined that twenty-two (22) respondents do not have any work experience in related communication fields.

Educational Attainment	Total
COMM Related Courses/Dev Com, Broadcasting Mass Comm, Journalism	21
MA in Communication/Comm Management	14
PhD Graduate	3
Others	2
Total	40

Table 4
Educational Qualifications

A majority of the respondents are graduates of Communication-related courses while two faculty members are graduates of Marine Engineering and Ph.D. Linguistics.

The following table corresponds to the exposure level of respondents to films such as:

- frequency of exposure
- medium of exposure
- elements watched in films

General Classification of Films		
Preference	Yes	No
Mainstream	10	0
Indie	2	0
Both	28	0

Table 5.
Respondents' preference for general film classification

The data shows that all of the respondents are exposed to Filipino films – both Indie (Independent Cinema) and Mainstream cinema.

Frequency of Exposure	
Frequency of watching	N=40
Very often	4
Often	9
Fairly often	17
Seldom	11
Not at all	0

Table 6.
Frequency of exposure

Twenty-eight (28) of the respondents have less exposure to films while thirteen (13) have high exposure. This notes Clarino's (Agence France-Presse, 2012) observation that local movies are not given as much support. It was also noted that thirteen respondents watch movies often while thirteen seldom watch movies. These films are watched usually in movie theaters or through cable TV.

When watching films, communication educators put the highest premium on the aspects of story concept or screenplay followed by cinematography, the casting of lead actors and actress or star appeal, then production design.

The artistic aspect of the Filipino film industry covers three factors; "screenplay" which got a mean score of 3.15 interpreted as "good status." "Acting" and "creativity" got mean scores of 3.5 and 3.4 respectively interpreted as "Satisfactory." Creativity covers the use of symbolism, lightings, and special effects in the presentation of the story.

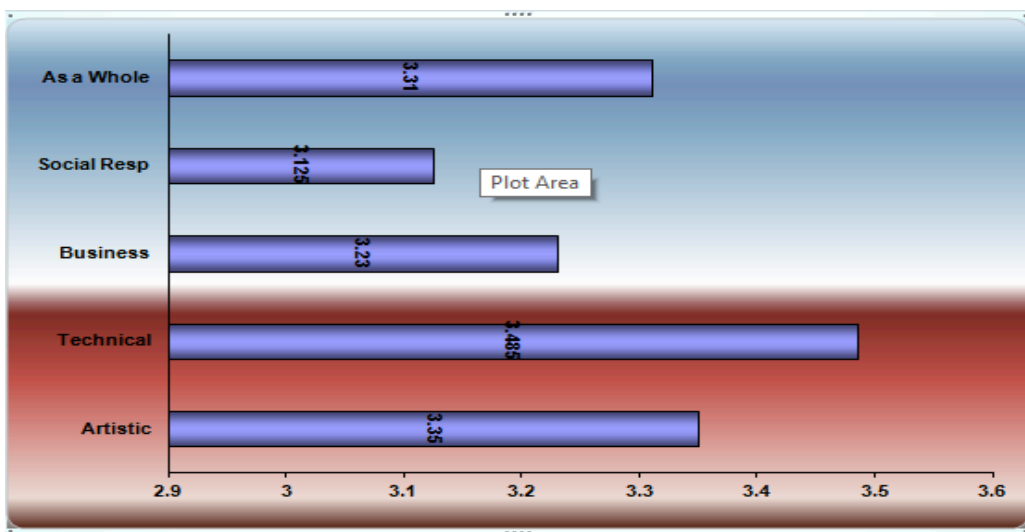

Figure 6. General Mean Scores of Four Aspects

The overall rating of the artistic aspect is 3.35 interpreted as "Good status." These results are similar with the 2001 study "Communication Educators in Metro Manila" which yielded the same results. The study determined that the majority of communication educators look for good story concept or screenplay in films that they watch. They believe that there is a need for good stories to elevate the state of the film industry for the audience to appreciate.

Regarding the current condition of the industry, communication educators expressed neutrality with 3.1 in terms of their satisfaction to the story concepts and creative approaches of Filipino films.

In an interview with Director Jose Mari Avellana (2001), he said that Philippine culture is so rich from its language, arts, and literature which can be used to come up with better film outputs (Garcia & Marasigan, 2001).

According to the Attorney Espiridion Laxa (cited in Garcia & Marasigan, 2001), former Chairman of the Film Academy of the Philippines (FAP), "In order for a movie to be considered a quality one, it must possess the following features: 1) good story, 2) believability, 3) well-written script, 4) good acting, 5) competent direction, and 6) technical aspects such as sound, photography, music, cinematography, etc. should be world-class." He reiterated that, even though a movie possesses the first five aspects, if it did not conform to the technical requisites, then it is not a quality movie because technicalities bring out the best in elements of the film.

Ms. Rosanni Sarile, a film educator, said that Filipino films lack creativity or uniqueness because filmmakers use the same “*kilig*” or romance formula without depth. An important aspect of a film is its ability to connect to its audience which is observed to be missing. In order to establish a connection with the audience, visuals are important and it comes with creativity and artistry in films.

Included in the technical component of a film are editing, directing, production design, cinematography, and sound. Directing got the highest mean of 3.67 which is interpreted as “Good status.” Cinematography Editing techniques follow. The lowest mean score was obtained for “production design” with 3.2.

The overall mean score is 3.47 interpreted as “Satisfactory.”

In general, technical aspect rated well with a total mean score of 3.48 which is the highest of all the aspects of film industry measured in whole. In an article from *Inquirer.net* (March 12, 2010), it was pointed out that the sound aspect of Filipino films is one of the most ignored parts of production work that can be attributed to lack of time especially for “*pito-pito*” movies (indie film), resources, budget, and experts in the field.

The business aspect of the film got a mean score of 3.2 with a mean value of 3.3 for earnings and 3.1 for budget both interpreted as “Good status.” With local films and Indie movies shown in mainstream cinema, some of these films earned well with proper marketing and promotional strategies. In 2013, the following movies earned the most during the Metro Manila Film Festival: “*Boy Girl Bakla Tomboy*” (429 million) followed by “*It Takes a Man and a Woman*” (405 million) both produced by Star Cinema. In 2014, Star Cinema produced “*The Amazing Praybeyt Benjamin*” (456 million) and “*Starting Over Again*” (410 million).

Still, there are Indie movies shown in mainstream cinema due to its remarkable reviews and awards in the Cinemalaya Independent Film Festival with the likes of “*Ang Babae sa Septic Tank*” (Woman in Septic Tank) which won Best Screenplay and Best Picture and was even nominated for the 6th Asian Film Awards. “*Transit*” (2013) competed in the 18th Busan International Film Festival and was even selected as the Philippine entry for Best Foreign Language Film in the 86th Academy Awards. These are low-budget films yet producers were able to get formidable returns of investments. Other independent films such as “*Thelma*” by Director Paul Soriano won the Bronze Palm Award for "demonstrating excellent and outstanding filmmaking" at the 2012 Mexico International Film Festival. <http://www.abs-cbnnews.com>

“*Thy Womb*” in 2012 of Director Brillante Mendoza was awarded three special prizes by other Italian film groups - La Navicella Venezia Cinema Award, the P. Nazareno Taddei Award - Special Mention, and the Bisato d' Oro Award for Best Actress (for Nora Aunor) given by an independent Italian critic group called Premio Della Critica Indipendente.

In September 2015, *Heneral Luna* made history through its promotion in social media. In five (5) weeks, the film earned 240 million gross ticket sales even with the 50% discount offered to student viewers. Facebook pages, Twitter, and other media platforms acknowledged the film’s excellent features apart from its story concept and cinematography.

Moral and social realism got mean scores 3.15 and 3.17 respectively interpreted as “Good status.” The statement “films educate or inform” received a mean score of 3.05 which is the lowest in this category.

An executive of ABS-CBN, Ms. Charo Santos Concio, during the 7th Pinoy Media Congress in 2012 said that the “economics of our country pushes Filipinos not to prioritize local movies much more socially responsible movies.” But according to Enrico Santos, head of the concept development group and new media for ABS-CBN Film Productions Inc., movie outfits now try to balance depth and feel-good entertainment. What is important is that movies promote discussion among its viewers in which they can reflect on their lives, give

substance - a catharsis where it mirrors our lives.

<http://www.abscbnnews.com/entertainment/03/01/12/>

As a whole, the Filipino film industry has a mean rating of 3.31, which means that the status of the Filipino film industry is perceived as “Good” by communication educators. Thus, the movie industry may still flourish. Social responsibility got the lowest mean score of 3.125 while the technical aspect got a high mean score interpreted as “Satisfactory”. It is followed by artistic and business aspects with 3.35 and 3.23 respectively.

Using one sample T-Test, the state of the film industry given the four aspects is rated as “Good” by communication educators. There is a slim dissatisfaction on the part of the respondents as far as the present status of the movie industry is concerned.

The table below presents the perceived condition of the film industry in which the majority of the respondents believe that new story concepts must be created for the audience to appreciate the industry anew. Communication educators perceive the industry negatively due to lack of better film materials or poor story concepts. Respondents have a slight agreement in terms of projection of positive values/moral lessons in our films, readiness to compete in the international market, and satisfaction in terms of its general state.

Perception on Current Condition of Film Industry	Mean	Rank	Remarks
A. There is a need to create good stories to elevate quality of Filipino films and the industry which will eventually be appreciated by Filipino audience.	3.775	1	Agree
B. I believe that the movie industry has improved in the last three years as seen in excellent production aspects	3.475	2	Agree
C. Films today project positive values and impart moral lessons to viewers	3.175	3	Neutral
D. I am satisfied with the general state of today’s film industry because of good story concepts and creative approaches of our films	3.1	4	Neutral
E. Local films are ready to compete in the international market	3.05	5	Neutral

Table 7.
Current condition of the film industry as perceived by communication educators

Respondents were instructed to rate problems through a scale where 1 is regarded as a major problem while 5 is not regarded as a major problem. It is revealed that the majority of communication educators believe that the industry has inadequately skilled movie workers with a mean score of 2.75. This was followed by competition with foreign films and the high cost of production. Over-taxation, lack of government support and film piracy followed next. Nestor U. Torre (in PDI, 2006) said that “the industry gets little support from the Government because the leaders do not see the value of the film medium.”

High taxation in films has been a pressing issue since then having the most heavily taxed in Asia that includes amusement tax, culture tax, income taxes, permit fees etc. Thus, the taxes imposed on filmmakers are shouldered by moviegoers. In order to support local producers, the local Government of Quezon City, the entertainment capital of the Philippines, reduced the amusement tax from 50% to 30% through a city ordinance in 2008 with 0% for local films (Inquirer.net 2010). In 2014, Buhay Party List Representative Lito Atienza filed

House Bill 3840 as a 5-year tax holiday for the film industry to help in its recovery. He believes that the Filipino film industry is dying due to the decline of a number of movies shown in theaters. Being one of the fastest growing industries, the Philippines was used to be recognized internationally in terms of creativity, originality, and talent (www.philstar.com).

The technical quality of foreign films made it difficult for the local industry to compete since moviegoers mostly watched films for entertainment and a sort of enjoyment and diversion. In an interview with cinematographer educator Mr. Richard Padernal, he said that the industry lacks a new breed of good filmmakers and movie workers. From the staff down to the key production heads and even directors, he attested to the unprofessional handling of important aspects of production and the process of filmmaking alone. He also reiterated the lack of support from government leaders considering that past President Joseph Estrada was an actor. Even some of the senators in the country failed to support the dying film industry then. The industry is not dying but the people who are working in the industry.

In contrary to what Padernal presented, one communication educator noted that “Filipinos artists are good directors and actors and have complete stable creative production staff. The producers are just around the corner. It is the story concept or idea that should be given emphasis. Filipinos are great filmmakers too. They just need support from the government.

The table below presents the perceived problems as attested by the respondents:

Problems	Mean	Rank
Inadequate skills of movie workers	2.75	1
Competition with foreign films	2.45	2
High Cost of Production	2.35	3
Over taxation	2.32	4
Lack of Government Support	2.12	5
Film Piracy	2.025	6

Table 8
Problems of Film Industry

Data reveals that patronizing Filipino films ranked first, followed by protection against film piracy and support from the government in terms of tax exemption. In an interview with professor and film maker Elvin Valerio, he said that educators need to use local films in classrooms. Still, he understands the reasons why some communication educators failed to do so because of the lack of film materials in schools. Most of the best films since the 1960s, 70s (Golden Age of cinema) and even in past decades are not archived due to the absence of a national film archive in the country.

Ms. Mojica of Cavite State University likewise said that as educators, support for the industry is shown by simply patronizing Filipino mainstream/indie films as well as encouraging students to watch films in the cinema though she sees the difficulty in convincing students to support the local film industry, unless there is an improvement in story concepts, lessons, or social implications in films. Ms. Rosanni Sarile reiterated that

We failed to educate our moviegoers but as communication professors, we educate our students. However, teachers need to be educated also in terms of

PERCEIVED STATUS OF THE FILIPINO FILM INDUSTRY

the use of local films for teaching and that is media literacy. But it seems only a few communication educators really watch local films and use them in teaching. (September 2015)

This perspective of Ms. Sarile was even attested by the views of Mr. Padernal and Mr. Valerio, filmmakers and educators who said that most of the communication educators use the old classic foreign films in teaching. Thus, appreciation of the cinema was in foreign films not in the local films among students, despite the fact that there are Filipino films that have been awarded locally and internationally.

This part presents the suggested solutions from the academic sector to address the present problems of the film industry. From the scale of 1-5 having 1 as the major solution down to 5 as the least solution. The highest rank in terms of the solution is to provide high-quality training to those who will constitute the backbone of the profession. This represents the need to educate students who will be the future workforce in the industry to be more creative.

The succeeding table presents the perceived solution to the problems:

Proposed Solutions	Mean	Interpretation	Rank
Patronize Filipino films	1.8	Major	1
Legislation for the protection against film piracy	2.15	Above A.	2
Support from government in terms of tax exemption/reduction	2.17	Above A	3
More training and seminar programs for movie workers	2.25	Above A.	4
Reduction of taxes imposed on film production	2.32	Above A.	5
Support from private sector for funding	2.32	Above A.	6

Table 9
Solutions to the Problems of Film Industry

Legend:

1.00-1.79	Major
1.80-2.59.1	Above Average
2.60-3.39.1	Average
3.40-4.19.1	Below Average
4.20-5.0	Least

According to Mr. Padernal, there is a need to educate students in the language of photography. Next is offering extension activities for faculty members to share their experiences and knowledge outside the academic community. The establishment of the Cavite Filmmakers Association in 2014 is a way to promote Philippine Independent film industry in the province of Cavite by initiating film showings, film competitions, workshops and training for students and other activities which will help enhance and develop skills of its members who will constitute the backbone of the industry. This organization will likewise promote Cavite culture and develop the new breed of filmmakers that the industry is longing for. The National Commission for Culture and the Arts (NCCA) National Committee on Cinema supports “Pelikultura” which was last held in De La Salle University-Dasmariñas in

cooperation with the Cavite Filmmakers Association, is an avenue where love for films and eye for details are being enhanced among the students.

Hence, the academic sector is already doing its part in the suggested solution mentioned that ranked 1st in this category. Regarding the inclusion of film appreciation subject in the curriculum, the K12 program has already included the subject in the Grade 11-12 curriculums.

Both Cinemalaya and CinemaOne film festivals aim to develop and provide an avenue for new breed of filmmakers but centered primarily in Metro Manila. In 2009, the National Committee on Cinema (NCC), under the National Commission for Culture and the Arts (NCCA), launched Cinema Rehiyon to bring the festival in several regions in the country with the hope of providing the needed support of local filmmakers (Valdoz, 2015).

SUGGESTED SOLUTIONS	MEAN	RANK
1. Provide high quality training to those who will constitute the backbone of the profession	1.725	1
2. Come up with extension activities to enable faculty to disseminate and share their expertise with groups, institutions, associations outside the academe	1.775	2
3. Strengthen the use of media education techniques(films) in the classroom	1.825	3
4. Allowing teachers and students to use the medium of film in teaching-learning process	2.025	4
5. Incorporate film appreciation subject in the curriculum	2.075	5

Table 10
Proposed Solutions from the Academic Sector

The respondents perceive the film industry as “Good” which means that there are still areas that need improvement to achieve a satisfactory mark. Findings of the study reveal that the majority of communication educators have a fair exposure to both mainstream and indie films which could possibly lead to the non-endorsement of local films for appreciation or critiquing. In terms of their exposure to the medium, it was evident that almost half of the respondents are exposed to local films through DVDs and cable TV.

Techniques	Mean	Rank
Conduct film showings and film discussions	7.44	1
Make videos, films, storyboards, scripts, etc. as part of the course requirements	7.025	2
Examine different symbolic codes employed in a particular medium, e.g., visual, auditory codes used in a film through critical analysis	6.76	3
Encourage students to support Independent Cinema or Indie films	6.54	4
Go on excursions to media institutions, film production outfits, film training schools and film centers, etc.	6.5	5
Invite guest speakers from film institutions to discuss on issues and conduct seminars on film criticism/appreciation	6.38	6
Discussion and debate on Filipino film industry and the experiences of the	6.25	7

PERCEIVED STATUS OF THE FILIPINO FILM INDUSTRY

students in relation to watching local films		
Use a role-play to explore the nature of the occupations involved in film production, e.g., writing, directing, production designs, editing, etc.	5.89	8
Conduct surveys and use questionnaires to investigate Filipino moviegoers' habits and preferences	5.5	9
Imitate a film product in order to explore the conventions, e.g., re-enact a particular scene from a film	4.88	10
Alter the form of film product to see what effect this has, e.g., adding or omitting sound tract or visual, editing, recording sequences of images	4.26	11

Table 11
Media Education Techniques

Conclusion

Results of this study reveal that the majority of the respondents have less exposure to films and that 11 out of 40 respondents seldom watch movies. These mainstream and indie films are mostly viewed through movie theaters, cable TV, and videos at home. When watching films, communication educators put the highest premium on the aspects of story concept or screenplay.

The academic sector suggested the following solutions on the problems of the film industry as follows: provide high quality training to those who will constitute the backbone of the profession; come up with extension activities to enable faculty to disseminate and share their expertise with groups, institutions, associations outside the academe; and strengthen the use of media education techniques (films) in the classroom.

It was evident that most communication educators ranked 1st the conduct of film showings and film discussions followed by the making of videos, films, storyboards, scripts etc. as part of the course as mostly used media education techniques in the classroom.

Communication educators believe that there is a need to educate film workers and personnel and not only intensify but also promote media education in secondary and tertiary levels. Suggestions were made to strive for originality, new formulas, better story concepts and use films as tools for education and not just for its entertainment value. They believe that, in order to elevate the status of the film industry, story concept and screenplay must be given crucial attention. Media education is a great responsibility and Cavite Communication Educators agree that they are called for to propagate the importance of such in this changing society.

References

- Baran, S. J., & Davis, D. K. (2012). *Mass communication theory: foundations, ferment, and future*. (6th Ed.) India: Cengage Learning.
- Baran, S. J., & Davis, D. K. (1995). *Mass communication theory: foundations, ferment, and future*. India: Cengage Learning.
- Bill seeks 5-year tax break for local film industry. (n.d.). Retrieved October 15, 2015, from <http://www.philstar.com/nation/2014/02/27/1295153/bill-seeks-5-year-tax-break-local-film-industry>
- Contending the present Issues of the Film Industry in the Philippines. (n. d.). Retrieved October 25, 2015, from <http://hubpages.com/entertainment/Contending-the-Present-Issues-of-the-Film-Industry-in-the-Philippines>
- Deocampo, N. (1995). *The FAP Educational Survey/Program*. Manilla : Philippines.
- Garcia, L., & Masigan, C. (2001). An in-depth study on the film industry in the Philippines. Retrieved November 05, 2015.
- Gervacio, R., Serquiña, S., & San Pedro, R. (2015). Perception of Philippine independent cinema as basis for promotion of cavite filmmakers association (Unpublished undergraduate thesis).
- Griffin, E. (2013). *A First Look at Communication Theory*. NY: McGraw-Hill Global Education Holdings.
- Media education: A teaching manual. (1995). Laguna, Philippines: AMIC-Philippines.
- Movie review: 'Heneral Luna' a hero for the millennial generation. (n.d.). Retrieved October 27, 2015, from <http://www.gmanetwork.com/news/story/536252/lifestyle/artandculture/heneral-luna-hero-for-the-millennial-generation>
- News archives (2014) - Senate of the Philippines. (n.d.). Retrieved October 10, 2015, from <http://www.senate.gov.ph/news.asp?year=2014>
- News. (n.d.). Retrieved October 27, 2015, from <http://www.abs-cbnnews.com/entertainment/03/01/12/why-ph-movie-industry-dying-downloaded-October-30,2015>
- Owens, D., & Hunt, P. (1985). *Teacher's Guide to Introduction to the Mass Media 1 & Understanding the Mass Media 1*, Dublin: Veritas Publication.
- Philippine Film Industry in decline. (2012). Downloaded from <http://entertainment.inquirer.net/30455/philippine-film-industry-in-decline#ixzz3qPkIZLek> downloaded October 27, 2015.
- Thy Womb. (n. d.). Retrieved November 5, 2015, from https://en.wikipedia.org/wiki/Thy_Womb
- Valdoz. (2015, July 30). Manila Times.
- Valera, I. E. (2001). Status of Filipino Film Industry as Perceived by Communication Educators: Implications to Media Education (Unpublished master's thesis). Pamantasan ng Lungsod ng Maynila.
- Why the PH movie industry is dying. (n. d.). Retrieved November 10, 2015, from <http://www.abs-cbnnews.com/entertainment/03/01/12/why-ph-movie-industry-dying>
- News. (n. d.). Retrieved October 27, 2015, from <http://www.abs-cbnnews.com/entertainment/03/01/12/why-ph-movie-industry-dying-downloaded-October-30,2015>

Achievements of the EU Member States

Silvia Megyesiová¹, Vanda Lieskovská²

University of Economics, Bratislava, Slovakia

¹Department of Quantitative methods, Košice, Slovakia

²Department of Commercial Business, Košice, Slovakia

Abstract

The 5 targets for the EU in Europe 2020 strategy are as follows: 1. Employment; 2. Research & Development; 3. Climate change and energy sustainability; 4. Education; 5. Fighting poverty and social exclusion. The main goals of the EU in the area of education are to reduce the percentage of the population aged 18-24 with at most lower secondary education to less than 10 % and to increase the share of the population aged 30-34 having completed tertiary studies to at least 40 %.

People with low educational level are more likely to be at risk of poverty. The share of early leavers from education has fallen steadily. In 2003, the indicator reached 16.4% with its minimum in Slovenia (4.6%) and maximum in Malta (49.9%). In 2014, the percentage of early leavers dropped to 11.2% with the lowest value in Croatia (2.7%) and the highest in Spain (21.9%). If this trend will continue, the target to reduce early school leaving rates to less than 10% by 2020 can be successfully achieved.

The proportion of the population aged 30-34 with tertiary educational attainment has been continuously increasing. In EU-28, the proportion reached only 25.1 % in 2003, with the lowest level in Malta (7.4 %) and the highest in Lithuania (42.6 %). But in 2014 the level increased to 37.9% with the highest proportion in Lithuania (53.3%) and the lowest in Italy (23.9%). The increasing trend makes it possible to believe that also this goal of the Europe strategy will be successfully reached.

Keywords: Europe 2020, Strategy, Education

Introduction

Education and training belong to the main priorities of the EU Member States. Education and training are crucial for both economic and social progress and increasingly important in a globalised and knowledge-driven economy, where a skilled workforce is necessary to compete in terms of productivity, quality, and innovation (Eurostat regional yearbook, 2015). Through education and training, it is possible also, in time of economic crisis, to boost productivity, competitiveness, or innovation. People who leave education and training prematurely often suffer from social isolation and poverty; these persons are associated with higher unemployment rates and lower paid jobs. Education can be an escalator out of social disadvantage, leading to better job prospects for youths facing greater risks of poverty and reducing the prevalence of income poverty in adult age (Machin, 2006). Tertiary education on the other hand provides highly skilled human capital. Low education and literacy skills belong to the variables that affect the unemployment and pessimisms of unemployed older workers (Hick, 2015). According to Gausas and Vosyliutė (2015) employers are not willing to employ people over 45 years old because they think that older people are at a disadvantage when it comes to communication skills, ICT skills, and foreign language skills. It is possible that a similar unwillingness to employ older people is not only evidence from Lithuania, but that as the ageing of the workforce is typical for all of the EU Member States, employers have to accept this situation. The education of the older population has a very important role in ageing societies. However, not only older people have problems to get a suitable job on the existing labour markets. In Europe, youth unemployment has been consistently higher than that of the older population since 1945, but since 2008, youth unemployment has been increasing at a particularly alarming rate, in some regions of Europe, the youth unemployment rate is well in excess of 50% (European Youth Forum, 2013).

The first main goal of the EU in the area of education is a reduction of the population aged 18-24 with at most lower secondary education to less than 10%. The indicator of early leavers represents the proportion of individuals aged 18-24 who had finished no more than a lower secondary level of education, and who were not involved in further education or training (Europe 2020 – web page). The second of the main goals of the EU in the area of education tend to increase the share of the population aged 30-34 having completed tertiary studies to at least 40%. It is expected that a growing number of jobs in the future will require a tertiary level of education.

The role of education is important on the job market; for example, the years of education demanded by the average U.S. job grew slowly but steadily from 2005 to 2009. In 2009 the average U.S. job required 13.54 years of education, up from 13.37 years in 2005 (Rothwell & Berube, 2011). More educated individuals fare much better in the labour market than their less educated peers, for example when the U.S. aggregate unemployment rate hit 10 percent during the recent recession, high school dropouts suffered from unemployment rates close to 20 percent, whereas college graduates experienced unemployment rates of only 5 percent (Cairo & Cajner, 2014). The higher the educational degree achieved, the higher the probability to participate to the labour market (Pastore, 2005). Education significantly increases re-employment success for unemployed workers. According to the research of Riddell & Song (2011) on the 1980 Census data, graduating from high school increases the probability of re-employment by around 40 percentage points and an additional year of schooling increases this probability by around 4.7 percentage points. Garrouste, Kozovska and Perez (2010) using the EU-SILC 2005 data confirm the hypothesis that the higher the educational level, the lower the probability of falling into long-term unemployment.

Findings

Positive development of the two main indicators of education give us the hope that the goals of the Europe 2020 agenda set as benchmarks for education will be successfully fulfilled.

Early leavers from education and training

The indicator for early leavers from education and training is defined as the percentage of the population aged 18-24 with at most lower secondary education. Lower secondary education refers to ISCED 2011 levels 0-2. People with low educational level are more likely to be at risk of poverty. The share of early leavers from education in the EU Member States has fallen steadily. In 2000, the indicator reached an average level of 17.6 % in the EU-27 with its minimum in Sweden (7.3 %) and maximum in Malta (54.2 %). In 2014, the percentage of early leavers dropped in the EU-28 to 11.2 % with the lowest value in Croatia (2.7 %) and the highest in Spain (21.9 %). The share of young people in the EU with at most a lower secondary level of educational attainment fell for 14 consecutive years from 17.6 % in 2000. If the trend continues, the EU target to reduce early school leaving rates to less than 10 % by 2020 can be successfully achieved. Unfortunately, in 2000, there were missing values of early leavers for altogether eight EU Member States. From 2002, the database of early leavers is complete. Lowest proportion of early leavers from education and training in 2002 was recorded principally in the east of the EU: Slovenia (5.1 %), Czech Republic (5.7 %), Slovakia (6.7 %), Poland (7.2 %), Croatia (8.0 %). But in Malta in 2002, the share of early leavers was as high as 53.2 %, in Portugal 45 %, in Spain 30.9 %, in Italy 24.2 %.

In 2014, nineteen EU countries achieved the proportion of early leavers lower than the EU average of 11.2 %. The following countries had the share of early leavers under the EU average: Croatia (2.7 %), Slovenia (4.4 %), Poland (5.4 %), Czech Republic (5.5%), Lithuania (5.9%), Luxembourg (6.1 %), Sweden (6.7 %), Slovakia (6.7 %), Cyprus (6.8%), Ireland (6.9%), Austria (7.0%), Denmark (7.8%), Latvia (8.5%), the Netherlands (8.7%), France (9.0%), Greece (9.0%), Finland (9.5%), Germany (9.5%) and Belgium (9.8%). This means that these nineteen EU Member States achieved the share of early leavers lower than the threshold rate of 10% already in 2014. The proportion of early leavers above the EU average was recorded in nine Member States: Spain (21.9%), Malta (20.3%), Romania (18.1%), Portugal (17.4%), Italy (15.0%), Bulgaria (12.9%), United Kingdom (11.8%), Estonia (11.4%) and Hungary (11.4%).

Not only has the indicator's total decline been typical for the EU, but also the disparities between the EU Member States has continued to move in a positive direction. The Treaty establishing the European Community defines economic and social cohesion as one of the main operational priorities of the Union. Cohesion is to be achieved mainly through the promotion of growth-enhancing conditions and reduction of disparities between the levels of development of EU regions (Monfort, 2008). One of the main priorities of the EU is also the convergence process of selected indicators. The convergence process can be measured using specific statistical methods. For detecting possible catching-up processes of early leavers the Sigma-convergence coefficient, which refers to a reduction of disparities among EU countries in time, was selected. The catch up progress was measured by standard deviation as one of the Sigma-convergence coefficients.

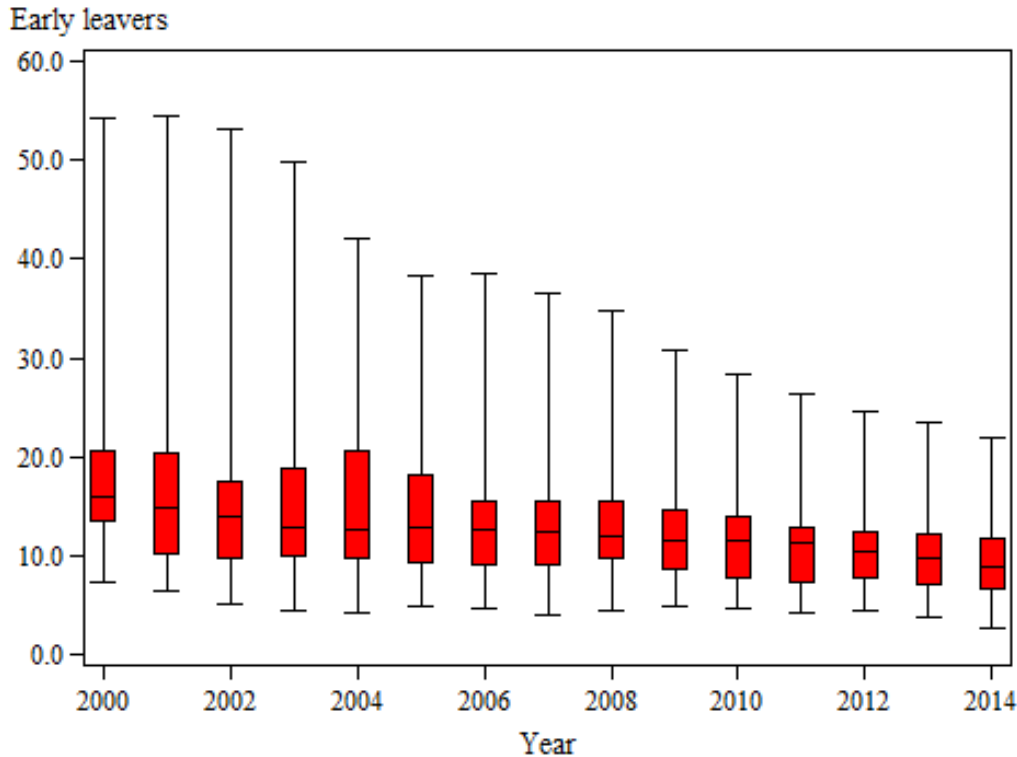

Figure 1 Early leavers from education and training in the EU (percentage of the population aged 18 – 24)

The variability measured by standard deviation of the early leavers – both male and female - declined steadily from 2002. While in 2002 the standard deviation of early leavers men achieved 12.3%, due to a catching up process the variability declined to only 9.6%. The same positive movement was attained in the variability of female early leavers. The starting value of the standard deviation was lower than the standard deviation of the male early leavers, the variability declined from 9.9% in 2002 to only 4.5% in 2014.

There exist some gender inequalities in education across the EU Member States. Gender inequalities have been shaped through history as a result of ideological, historical, cultural, social, religious, political and economic factors (Eurostat regional yearbook, 2015). Education affects peoples life, it provides qualification and skills that are necessary to enter the labour market and so education affects the potential earnings, career development, employment, social exclusion, poverty.

The likelihood of leaving education or training early is higher among men (19.0 % in 2002) than it is among women (14.9 % in 2002). The proportion of females, aged 18-24, who were not in further education or training fell from 14.9 % in 2002 to 9.6 % in 2014. In the same period, the rate of male early leavers decreased from 19.0% to 12.8% in 2014. The female rate in 2014 already reached the Europe 2020 threshold of 10%. In each year, the female rate for female early leavers was lower than the rate for men. The highest gender gap (gender gap in percentage points represents the difference between the share of the early male and female leavers) was achieved in 2004 (4.6 p.p.). The gap between the share of early male and female leavers closed somewhat and in recent year the female rate of early leavers was 3.2 p.p. lower than the corresponding rate for males. The trend of development of early leavers was positive from 2002. This indicates that not only did the share of 18-24 year old in the EU-28 declined for 14 consecutive years from 2002, but also that the disparity between the EU Member States declined rapidly. The gender gap closed slowly between women and men, which is also a positive sign of development of early leavers.

EU-28	Early leavers, in %		Variability - standard deviation		Gender
	males	females	males	females	gap, in p.p.
2002	19,0	14,9	12,3	9,9	4,1
2003	18,5	14,3	11,7	9,5	4,2
2004	18,3	13,7	11,0	8,4	4,6
2005	17,7	13,6	10,0	7,0	4,1
2006	17,4	13,2	9,6	6,9	4,2
2007	16,9	12,8	9,1	6,8	4,1
2008	16,6	12,6	8,8	6,3	4,0
2009	16,1	12,3	8,2	5,9	3,8
2010	15,8	11,9	7,6	5,5	3,9
2011	15,3	11,5	6,8	4,8	3,8
2012	14,5	10,9	6,2	4,4	3,6
2013	13,6	10,2	5,7	4,5	3,4
2014	12,8	9,6	5,4	4,5	3,2

Table 1 Early leavers from education and training by sex, EU-28
(Percentage of the population aged 18 – 24, standard deviation, and gender gap in percentage points (p.p.))

To continue the successful way in reducing the share of early leavers it is necessary to secure that education has to be free, accessible for all, with measures to prevent early school leaving a measures for second-chance education (European Youth Forum, 2013).

Tertiary educational attainment

Employment opportunities may be one of several pull effects that result in an increase of the proportion of highly-qualified young people. Low levels of tertiary educational attainment can hinder competitiveness and undermine the EU’s potential to generate “smart growth” (Eurostat regional yearbook, 2015). The proportion of the population aged 30-34 with tertiary educational attainment has been continuously increasing. In the EU, the proportion reached only 22.4 % in 2000, with the lowest level in Malta (7.4 %) and the highest in Lithuania (42.6 %). In 2014, the EU average level increased to 37.9 % with the highest proportion in Lithuania (53.3 %) and the lowest in Italy (23.9 %). If the trend will continue, the EU target to increase the share of the population having completed tertiary studies to at least 40 % by 2020 can be successfully reached.

Due to lack of data on tertiary educational attainment for some EU Member States, in table 2 the comparison of the share of 30-34 year-olds young people who has completed a tertiary or equivalent education is presented. Tertiary educational attainment in the EU rose on the year-to-year basis from 2002 for both sexes. In 2002, only in one EU country (Finland) did the proportion of tertiary educational attainment over count the Europe 2020 benchmark of 40%. In the same year, the share of population with tertiary educational attainment lower than 20% was achieved in the following EU Member States: Romania (9.1%), Malta (9.3%), Slovakia (10.5%), Czech Republic (12.6%), Portugal (12.9%), Italy (13.1%), Poland (14.4%), Hungary (14.4%), Croatia (16.2%) and Latvia (17.3%).

A positive development in the field of education was signified by an enormous increase of number of countries which in 2014 over count the threshold of 40% for tertiary educational attainment versus only one country in 2002. Altogether 16 EU countries had the share of population aged 30-34 with tertiary education higher than the forecasted threshold of 40%: Lithuania (53.3%), Luxembourg (52.7%), Cyprus (52.5%), Ireland (52.2%), Sweden (49.9%), the United Kingdom (47.7%), Finland (45.3%), Denmark (44.9%), the Netherland

(44.8%), Belgium (43.8%), France (43.7%), Estonia (43.2%), Spain (42.3%), Poland (42.1%), Slovenia (41.0%) and Austria (40.0%).

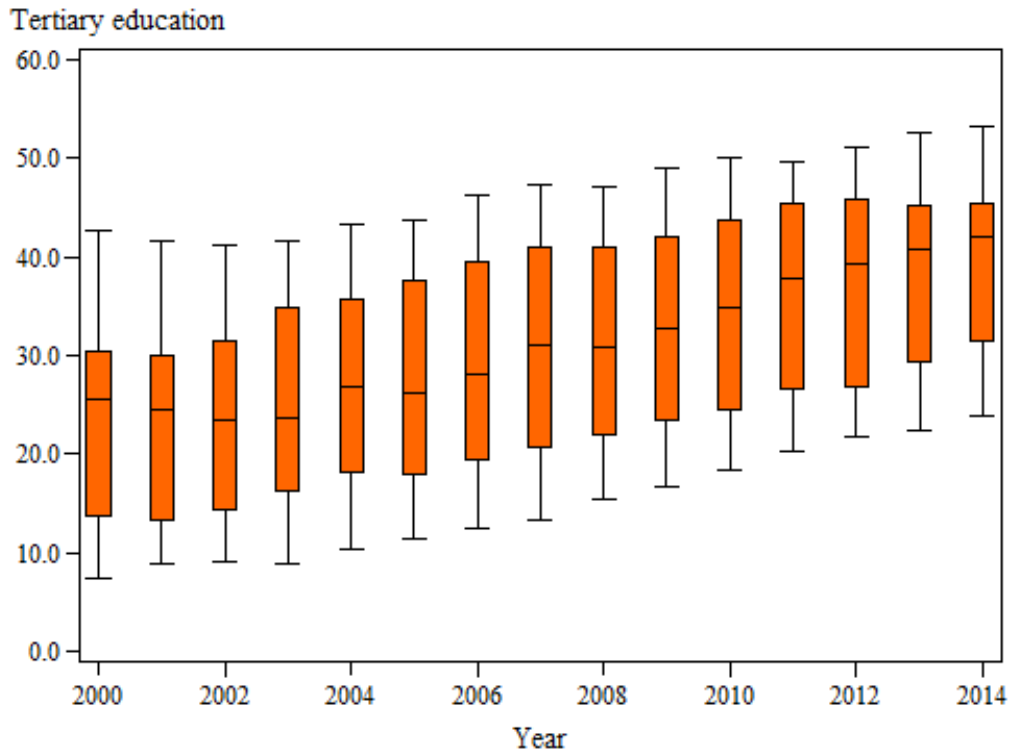

Figure 2 Tertiary educational attainment, EU – 28 (percentage of the population aged 30 – 34)

In the EU 22.6 % of men, aged 30-34 years had attained a tertiary level of education in 2002; this was lower than the share for women of the same age, which stood at 24.5 %. The 2002 gender gap reached 1.9 percentage points. But the gender gap rose steadily on an annual basis. In 2014, the proportion of men, aged 30-34, with tertiary education increased to 33.6%, but the share of women with tertiary education increased more rapidly to 42.3%. Therefore, to a faster increase of the share of well-educated women the disparity between the sexes widened and reached 8.7 p.p. in 2014. Although the proportion of 30-34 year-olds with a tertiary level of education rose considerably between 2002 and 2014 in total, due to a slower increase in share of men with tertiary education compared to women, the gender gap between both sexes increased. The variability of share of tertiary educational attainment did not change a lot. The standard deviation of men's proportion was lower than the variability of women's tertiary educational attainment.

EU-28	Tertiary educational attainment, in %		Variability - standard deviation		Gender gap, in p.p.
	males	females	males	females	
2002	22,6	24,5	9,0	10,6	-1,9
2003	24,0	26,1	9,5	11,0	-2,1
2004	25,3	28,6	9,8	11,0	-3,3
2005	26,1	30,1	10,0	11,5	-4,0
2006	26,3	31,6	10,1	12,2	-5,3
2007	27,2	32,9	9,9	11,9	-5,7
2008	28,0	34,4	9,5	12,2	-6,4
2009	29,0	35,7	9,9	11,7	-6,7
2010	30,3	37,3	9,5	11,2	-7,0
2011	31,0	38,6	9,0	11,3	-7,6
2012	31,8	40,2	9,2	11,5	-8,4
2013	32,8	41,4	8,7	11,1	-8,6
2014	33,6	42,3	8,7	10,2	-8,7

Table 2 Tertiary educational attainment by sex, EU-28
(Percentage of the population aged 30 - 34, standard deviation, and gender gap in percentage points (p.p.))

Conclusion

The Member States of the European Union have understood the very important role of education. The main targets of the EU in the field of education are ambitious. The trend of development of the selected indicators is positive.

For both Europe 2020 indicators related to education is typical a strong convergence process. The aim of reducing disparities between the EU Member States is enshrined in the EU Treaty. The disparity, measured by coefficient of variation, of the early leavers was in 2000 as high as 65.3%. Due to a positive convergence process, the disparity declined to 40.4% in 2012. A slower divergence was achieved in 2013 and 2014 compared to 2012. The disparity of the tertiary education indicator was smaller than in case of the early leavers. The coefficient of variation reached in 2000 a level of 44%. Due to a positive convergence process, the disparity indicator dropped to 24 % in 2014.

References

- Cairo, I. & Cajner, T. (2014). *Human Capital and Unemployment Dynamics: Why More Educated Workers Enjoy Greater Employment Stability*. Washington: Federal Reserve Board, Finance and Economics Discussion Series.
- European Youth Forum. (2013). *Policy paper on youth employment*. Adopted at the Council of Members. Brussels. COMEM/GA 0166-13.
- Europe 2020. (n.d.). Retrieved from http://ec.europa.eu/europe2020/index_en.htm.
- Eurostat. Databases. (n.d.). Retrieved from <http://ec.europa.eu/eurostat/data/database>.
- Eurostat regional yearbook 2015*. (2015). Luxembourg: Publications Office of the European Union.
- Garrouste, Ch., Kozovska, K. & Perez, E.A. (2010). *Education and Long-Term Unemployment*. Ispra: Joint Research Centre, Institute for the Protection and Security of the Citizen.
- Gausas, S. & Vosyliute, L. (2015). Local economic strategies for ageing labour markets: Marijampolė's Third Age University in Lithuania. *OECD Local Economic and Employment Development Working Papers, 2015/01*. Paris: OECD Publishing.
- Hicks, P. (2015). Local economic strategies for ageing labour markets: The Canadian Targeted Initiative for Older Workers in Fort St. James, British Columbia. *OECD Local Economic and Employment Development Working Papers, 2015/03*. Paris: OECD Publishing.
- Machin, S. (2006). Social Disadvantage and Education Experiences. Paris: OECD, Directorate for Employment, Labour and Social Affairs. OECD Social, Employment and Migration Working Papers
- Monfort, P. (2008). Working papers. Convergence of EU regions Measures and evolution. *European Commission, Regional Policy: A series of short papers on regional research and indicators produced by the Directorate-General for Regional Policy*.
- Pastore, F. (2005). *To Study or to Work? Education and Labour Market Participation of Young People in Poland*. Bonn: Institute for the Study of Labour. Discussion Paper No.1793.
- Riddell, W. C. & Song, X. (2011). *The Impact of Education on Unemployment Incidence and Re-employment Success: Evidence from the U.S. Labour Market*. Bonn: Institute for the Study of Labour. Discussion Paper No.5572.
- Rothwell, J. & Berube, A. (2011). *Education, Demand, and Unemployment in Metropolitan America*. Washington: Metropolitan Policy Program at Brookings.

Lecturer Perception of Modern Technology Usage for the Teaching of Business Education Courses in Nigeria

Emeka G. Nwokocha

Federal College of Education (Technical) Omoku
Department of Accounting Education
Rivers State, Nigeria

Abstract

The study was set out to empirically investigate Lecturers perception in the utilization of modern technologies in the teaching of business education courses in tertiary institutions in Nigeria. Two research questions were posed to guide the study, while one hypothesis was formed and tested at 0.05 level of Significance. A total of 124 lecturers from seven (7) Institutions in Nigeria were selected through the Judgemental sampling technique to form the Sample of the study out of the 187 lecturers that constituted the population of the study. The instrument for data collection for the study was titled 'Lecturers Technology Adaptation Questionnaire (LTAQ),' with a four point rating-scale ranging from strongly Agree to Disagree. Three (3) Business Education experts from three institutions validated the instrument and a reliability test using Pearson Product Moment correlation co-efficient yielded a reliability index of 0.68. Descriptive statistics (weighted mean) was used to answer the research questions, while inferential statistics (T-test and Anova) were used to test the hypotheses. Findings reveal among others that lecturers differ in their perception of utilization of modern technology in delivery of business education courses. It was also found that there was no effect of gender on lecturer's perception of the utilization of modern technology. Based on the findings, recommendation made among others were that lecturers should be trained on the use of modern technologies which should be both technical and pedagogical and also to use the basic computer knowledge possessed by them to integrate modern technologies in the teaching of business education courses in our schools for quality and functional skills development.

Keywords: Modern technology, Perception, Business education, Teaching

Introduction

Soon after political independence, most developing African countries began to embark on major reforms, virtually in every aspect of life of the nations. One of such major areas of reform has been the introduction of new educational systems aimed at meeting the needs, aspirations of the country concerned. As a developing country, Nigeria has had to reposition her educational systems to meet such needs, aspirations and expectations, given that education is an important ingredient for national development (Ehiamezor, 1990 in Ubulom, 2014), as well as an instrument “par excellent,” for effective development (Federal Republic of Nigeria; FRN 2004). The Nigerian Government in recognition of this, desired to attain the vision 20-20-20 and the Millennium Development Goal (MDG) by propelling the Nigerian Educational Research and Development Council to revise the education curriculum to meet the changing need of the society.

To provide the basis for the needed reform, renewal and modification resulting from the curriculum change, the Federal Government of Nigeria introduced the business education programme with a delivery system that relies on the extensive acquisition of vocational skills and competencies with the extensive use of equipment and relevant tools. Business Education encompasses a wide coverage of courses which includes; Secretarial Education (now Office technology and management Education (NBTE ,2010) 2. Accounting Education, 3. General Business (Management) Education, 4. Cooperative Education, 5. Purchasing and supply Education, 6 and 7. Distributive and Marketing Education. In fact one of the rationales for the emphasis on business education programme is the fact that it is a skill for gainful employment (Osuala, 1989; Oyenuga, 2003 in Ubulom, 2014). As Otamiri (2014) puts it, business education involves the study of technologies and related sciences and the acquisition of practical skills including teaching skills attitudes, understanding and knowledge related to occupation in various sectors of our economy and social life. For our educational systems to deliver on their mandates, the quality of the training given to individuals passing through a course or the other should be such that can give adequate skills and information needed in the real world sense.

Consequent upon the stipulations of the policy commission for business, and the provisions of the national policy on Education, several authors (Anao, 1986; Ubulom 1999; Aina, 2002; Otamiri, 2009 in Otamiri, 2004) enunciated the goals of business education to include:-

- To prepare effective management, secretarial, marketing, Accounting and Banking executives
- To produce lecturers and teachers who will handle business and related courses in our schools, colleges and universities
- To propagate the development of the business thought and philosophy in our daily existence
- To prepare and equip those who pass through the programme to be able to establish and run their own business ventures as self-employed citizens of the society

Despite this zeal shown by the government to produce a well-rounded business education graduate, there has been mounting criticisms in Nigeria that Business education graduates are not competent in the use of modern technologies. As noted by UNESCO (2002), the use of information and communication technology in teaching and learning process is still in its infancy in Nigeria. Faluyi (2002) observed that the curriculum is inadequate for meeting the needs of the 21st century. The use of the curriculum has led to the disappointment of both the employers and employees as a result of graduate’s inability to meet up with modern technologies. Okoli; 2012; Inije 2012) noted that modern technologies

are devices or set of technological devices and resources used to communicate and to create, disseminate, store and manage information. These technological resources that are available for delivery of business education include; E-mail, cell phone, optical fibre technologies, internet, intranet, extranet, computer, radio, YouTube, interactive CDs, Interactive white boards, satellite TV, videophone system, PowerPoint video conferencing and teleconferencing.

The development of adequate, quality and functional skill is an important characteristic of Business Education. The major objective of business education in schools is to enable students possess the necessary skills for workplace; its emphasis is on exposure to and acquisition of knowledge and skills relevant and adequate for employment in specific business areas or for self-reliance. In the teaching of business education as a functional skill subject, lecturers are encouraged to provide opportunities for students to apply their knowledge and skills to real-life situations which gives more relevance to what is studied.

Recognising this fact, the National Educational Objectives stated that the acquisition of appropriate skills, abilities and competencies both mental and physical are important for all Nigerians to live and contribute to the development of the society. Recently, much attention and discussions has been evident in terms of the manner and process of providing education by lecturers. Albrecht and Sacks (2000) opined that there are various innovative instructional approaches that should be adopted to improve the educational aspect of business education. A substantial body of literature and evidence has shown that teacher's beliefs play critical and important roles in adopting instructional pedagogy. According to Pajares (1992), beliefs about teaching include perception about what it takes to be an effective teacher. The way lecturers view modern technology will to a large extent determine the level and degree of usage. Despite the availability and recommendation of innovative method of instruction which have been tested and found viable for the improvement of learning, male and female lecturers alike still exhibit absolute loyalty and dependence on the expository method in which they simply deliver a pre-planned instruction to the learner with or without the use of modern technologies. According to Abdelraheem (2004), lecturers form an impression which is favourable or otherwise, depending on specific traits they possess and what they attribute to the method. Their perception of instructional approach is predicated upon what they feel the method can do in the teaching-learning process. Lecturer's instructional approach, beliefs and utilization are influenced by their philosophy, resistance to adopting new technologies (Abdelkareem, 2004).

Theoretical and Conceptual Framework

The theoretical base of this study hinges on the model for the study of classroom teaching as developed by Dunkin and Biddle (1974). The model contains variables of the teacher, which includes personality, preparation, general characteristics, background, competencies and inadequacies, teacher's education, experiences and teacher properties. All these activities they considered as process variables. While those characteristics associated with the effects of instruction, they called product variables. The model recognizes presage variables as fundamental in understanding classroom environment, interaction between the teacher and the students and the effects of instruction. According to Wale (2005) lecturers needs to understand a subject enough to convince its essence to students. Wale observed that technology is an increasing influential factor in education which offers powerful learning tools that demand new skills and understanding of students including multimedia and provide new ways to engage students such as virtual learning environment.

The way a lecturer views the role of media in classroom teaching will to a large extent determine the level and degree of its usage. In recent years in Nigeria, most tertiary institution has shown a rapidly growing trend in integrating ICT into educational curricula

and is matching towards E-learning. Unfortunately, the utilization of these modern technologies in business education delivery in our tertiary institutions has remained a mirage due to a number of constraints (Nwokocha & Onwuchekwa 2014). This unsatisfactory manner of practice in the delivery of business education programmes in line with technological innovations has created a vacuum in the attainment of the national technology objectives and non-performance of the graduates in the business world. New technologies are seen as bedrock of national survival and development in a rapidly changing global environment.

Business educators today however face the challenge of utilizing and integrating computer and related technologies in their instructional delivery in a manner that enhance students learning and achievements. Appropriate use of these resources in Business education delivery in our classrooms can help equip future Business educators with the necessary knowledge and skills to use same tools effectively in their classroom (Miller, in Nwokocha & Onwuchekwa 2014). As noted by Hennessy, Harrison and Wamakote (2010), effectively introducing technology into schools is also largely dependent upon the availability and accessibility of modern technology resources (e.g. hardware, software and communications infrastructure). They observe that if technology cannot be accessed by the teacher, as in so many educational settings in Sub Sahara Africa, then it will not be used.

Eichoiz and Rogers (1994) suggested that there are psychological components in lecturer's perception of media. They found a significant personality difference between acceptor and rejecters of new media, other researchers have also said that some lecturers appeared to perceive media as threatening and perhaps in human. The success of modern technology utilization in business education depends on the development of various competencies throughout the educational system. This hinges on the lecturers professional development, competency of educational administrators in using the technology available and dedicated technical support specialists to ensure continued viability of modern technology tools in education.

According to Gulbaharha and Guven (2008) any successful transformation in educational practice requires the development of positive user attitude towards new technology. Teachers attitude are major predictors of the use of new technologies in instructional settings (Gulbahar & Guven 2008, Echoiz & Rogers 1994 & Rogers 1995). One of the major factors affecting people's attitude towards a new technology is related to the features of the technology itself. Rogers (1995) pointed out five basic features of technology that affects its acceptance and subsequent adoption. These are; relative advantage, compatibility, complexity, Observability and trainability. Thus a new technology will be increasingly diffused if potential adopters perceive that innovation has an advantage over previous innovations, is compatible with existing practise, is not complex to understand and use, shows observable results and can be experimented within a limited basis before adoption. There are further, important teacher-related factors influencing classroom use that become apparent. These are predominantly modern technologies literacy and confidence among teachers, and education of subject teachers to assist them in integrating modern technology into learning areas.

Statement of the Problem

The role of beliefs as an indicator of lecturer's behavioural change has received increasing attention among researchers and educators over the last few years. A substantial body of literature and evidence has emerged, during this time. Supporting that, lecturer's beliefs play critical and important roles in adopting instructional pedagogy.

In spite of documented evidence of the advantages of the multiple intelligence based instructional approach in many subject area in the development of psycho-motor skill, and a great amount of money, efforts and time expended on the use of technology in schools at all levels, most lecturers seem reluctant in integrating new technologies into their teaching, learning process. Many of the lecturers teaching business education courses seem to be showing apathy towards the use of modern technologies. Despite the potential of increased instructional effectiveness, economic financial investment, and the ability of modern technologies to enhance quality and functional skill development in business education, the utilization of modern technologies in tertiary institutions in Nigeria continue to remain a mirage.

It's on this premise therefore, that this study sort to investigate the use of modern technology and lecturer's perception in teaching business education courses in tertiary Institutions in Nigeria.

Purpose of the Study

The study was carried out to determine the use of modern technologies and lecturers perception in teaching business education courses in tertiary institutions in south- east and south- south Nigeria.

Specifically, the study sought to;

- i. Determine lecturer's perception and utilization of modern technologies in teaching business education courses
- ii. Establish factors affecting lecturer's utilization of modern technologies in teaching business education courses.

Research Question

The following research questions were formulated to guide the study

1. How do lecturers (male and Female) perceive utilization of modern technologies in teaching business education courses in tertiary institutions in Nigeria?
2. What are the factors affecting lecturer's utilization of modern technologies in teaching business education courses in tertiary institutions in Nigeria?

Hypothesis

The following null Hypotheses tested at 0.05 level of significance. There is no significant difference between lecturers (Male and Female) perception of utilization of modern technologies in teaching business education courses in tertiary institutions in Nigeria.

Method

This study adopted a descriptive survey design because it was aimed at ascertaining and establishing the status quo, facts of information concerning the population. The population of the study consisted of all lecturers in schools and departments of Business Education in tertiary institutions located in Akwa Ibom State, Delta State, Edo States, Imo State and Rivers State of the South- East and South- South Nigeria. Statistical information from the schools puts the figure at 187 lecturers. Through judgmental sample approach, 134 lecturers taking business education courses were selected for the study. The samples of lecturers were stratified into two: male (68) and female (56), according to their participation in the survey.

The data for this study were collected using a survey instrument titled "Lecturers Technology Adaptation Questionnaire (LTAQ)". The instrument was in two parts: Part A was made up of four (4) questions on demographic data. Part B was a (32) items questions on a 4- Point rating-scale format with response alternatives ranging from strongly Agree (SA) to Disagree (D) depending on the degree of agreement to each trait, the respondent scored 4, 3, 2 and 1 on the attitudinal traits, beliefs or perception description. The validation of the

instrument was done by three business education experts in three institutions which did not participate in the study. Additions and deletion to the attitudinal traits originally listed by the researcher were made before administering the instrument in the final form for the respondents. A reliability index of 0.68 was obtained when the instrument was trial tested on 45 Business education lecturers. The Pearson product moment correlation was used to establish the consistency and reliability of the instrument. The researcher and research assistants administered the questionnaire and also retrieved them. Except for minor discrepancies and unfilled sections, the bias level was not serious enough to undermine the results of the study. The rate of return stood at 124, out of 134 (92.5%). The statistical tool used for the study was mean, t-test and analysis of Variance (Anova). The hypotheses were tested at 0.05 level of significance. The mean were used for the research questions. Any variable that fell below 2.5 was negative and so rejected, while variables with 2.5 and above was positive and so accepted. The null hypothesis was rejected, if the calculated t-values or Anova was greater than the critical value, on the other hand, if the calculated t-value or Anova was less than the critical value, the null hypothesis was accepted.

Results

Research Question 1

How do lecturers perceive the utilization of modern technology?

S/N O	Statement/Options	SA	A	S D	D	Σfx	X	D
1	I feel comfortable using modern technology like computer aided tools.	80	90	76	36	282	2.29	R
2	Instructional technology increase student's interest and quality of courses.	140	87	52	34	313	2.52	A
3	Computer promotes the development of students in personal skills (ability to relate or work with orders).	108	93	72	30	303	2.44	R
4	Enhances professional development and ease pressure on teachers.	130	84	60	32	312	2.52	A
5	Instructional technologies motivates students to get involved in learning activities which improves learning	140	96	58	28	322	2.60	A
6	I am confident and comfortable using interactive white Board for instructional delivery	108	90	76	29	303	2.44	R
7	I am gaining a sense of self confidence in using computer for specific tasks and I am starting to feel comfortable using computer	156	96	72	17	341	2.75	A
8	I feel the use of modern technology does not make any difference when compared with the conventional approach.	128	105	60	27	320	2.58	A
9	I am not really computer literate to use computer aided tools in my classroom.	120	168	52	12	352	2.84	A
10	Given lecturers the opportunity to be learning facilitators instead of information providers.	80	99	76	33	288	2.33	R
11	It creates new options that makes instructional approaches in business education utilizable	130	60	84	32	323	2.52	A
12	Promotes the achievement of quality and functional skills development in Students	105	127	61	27	320	2.58	A
13	Using modern technologies can increase students attention span in classroom	128	105	60	27	320	2.58	A
14	Use of modern technology can facilitate the acquisition of basic skills through drills and practice	130	60	84	32	323	2.52	A
15	I don't really think modern technology has any serious impact on students achievement	140	96	58	28	322	2.60	A
16	Am not too sure if I can effectively use modern technology in my lesson delivery	128	87	66	30	311	2.51	A
	Grand Mean						2.54	A

Table 1: Lecturers Perception of Utilization of modern Technology

The results in Table 1 show that lecturers tend to have a positive perception towards the use of modern technology in the delivery of Business Education courses. This is shown in the grand mean obtained (2.54).

Research Question 2:

What are the factors affecting lecturers utilization of modern technology.

S/N O	Statement/Option	SA	A	SD	D	Σfx	X	DC
17	Most lecturers are inefficient in technical knowledge required to prepare instructional materials based on modern technology.	136	192	28	12	368	2.96	A
18	Most lecturers are not trained on delivering lectures with modern technology.	120	192	36	18	366	2.95	A
19	There is no provision of incentives for encouraging lecturer's technology usage.	200	144	60	6	410	3.31	A
20	Lack of interest of lecturers in modern technology usage	56	102	100	26	284	2.29	R
21	I really don't feel comfortable using computer aided tools to teach.	56	180	36	32	298	2.91	As
22	Deficiency in professional knowledge and skill on technology applications	120	168	52	12	352	2.83	A
23	Inability to adapt to the constant changes in technological tools.	156	96	72	17	341	2.75	A
24	Inadequate time to prepare and deliver lecture using modern technology	80	99	76	33	288	2.33	R
25	Lack of continuity in training in E-learning application software	56	180	36	32	298	2.91	A
26	Inefficiency of lecturers technical knowledge to prepare materials based on new technology	120	192	36	18	366	2.95	A
27	High cost of training and retraining of lecturers to acquiring new skill in modern technology	116	102	50	36	304	2.45	R
28	High cost of acquiring and installing modern technology in the classrooms	128	102	60	28	318	2.56	A
29	Inability of the government to implement policies on modern technologies usage	160	78	60	28	326	2.62	A
30	Lack of technological infrastructure and inefficiency of technology usage in institutions	144	114	52	24	334	2.69	A
31	Deficiency in professional development opportunities for gaining of knowledge and skill in modern technology	116	120	48	31	315	2.54	A
32	Lack of internet connectivity in the classrooms	136	111	58	24	329	2.65	A
33	Challenge of application of curriculum content to software's	128	105	50	27	320	2.58	A
	Grand mean						2.71	A
	Table 2 Factors affecting lecturers utilization of modern technology expressed by weighted mean(X)							

The analysis in Table 2 above shows factors affecting lecturer's utilization of modern technology in delivery of Business Education courses. With a grand mean of (2.71) which is above the (2.50), indicates that lectures inability to use modern technology hinges on a number of variables.

Testing of Hypothesis 1

Table 3 below shows computed T-value of (7.919) and T-critical value (1.96) at 122 degree of freedom tested at 0.05 level of significance. Since calculated T-value is greater that table-value, the null hypotheses is rejected, this implies that there is a significant difference between Lecturers Perception of Utilization of Modern Technologies in teaching of Business

Education Courses. The table also showed that lecturers with positive perception had a mean of 96.37 and those with negative perception had a mean of 27.63. The difference between their mean (68.74) was significant. This indicates that lecturer's utilization of modern technologies can be predicted on their perception.

Variables	N1 N2	$\sum x1$ $\sum x2$	S1 S2	X1 X2	T	Decision
Positive perception	96.37	2602	1998.09	96.37	7.919	*S
Negative perception	28.63	746	384.55	27.63		
Total	124	3348				

Table 3: T-test Analysis of Utilization of Modern Technology and lecturers perception in teaching of Business Education Courses. N=124; T122 critical = 1.96; *S= significant @ P <0.05.

Table 4 below shows no significant difference between male and female lecturers in their perception of the Utilization of Modern Technologies in teaching of Business Education Courses. As shown in the table, the critical value of F-ratio @ 1 degree of freedom of the numerator mean square and 120 df for the denominator mean square at 0.05 alpha level (3.94) is greater than the calculated F-Value of 0.0001. We therefore retain the null hypothesis of no significant difference between male and female lecturers with positive and those with negative perception of utilization of modern technologies. This implies that sex has no influence on their perception of utilization on of modern technology.

Source of variation	Sum of squares	Degrees of freedom	Mean square	F-Ratio	Decision
Main effects					
Perception (C)	14.39	1	14.35	0.0292	*Ns
Sex (r)	0.03	1	0.03	0.0001	*Ns
Interaction					
Sex X perception	1.27	1	1.27	0.0026	*Ns
Within	59,072.28	120	492.27		

Table 4: summary of data for a 2x2 multi-factor analysis of variance classified by lecturers' perception (positive and negative) towards use of modern technology and gender (male and female).

F_{1, 120} critical =3.94; *Ns = Not significant @ P<0.05

It was also shown in the table that perception had no significant effect as the calculated F-ratio of 0.0292 was far below the table values of F-ratio of (3.94).

Besides the main effects of Sex and Perception of Utilization of Modern Technologies, the interaction of sex and perception of modern technologies was also insignificant as the calculated F-ratio 0.0026 was far less than the f-critical of 3.94, it can therefore be concluded that the effect of gender on lecturers perception of utilization of modern technology does not depend on their perception of the technology.

Discussion

The findings of this study revealed that a significant difference existed between lecturers perception of utilization of modern technology in delivery of business education courses in tertiary institutions. Lecturers with positive perception had a mean response rate of 96.37 while lecturers with negative perceptions had a mean response rate of 27.63 the difference of 68.74 between their means was significant. This finding is in agreement with Gulbaharha & Guven (2008), who found a significant relationship between lecturer's attitude towards computers and successful integration of computers in the teaching of social studies in Turkey. They stated that lecturers who have a high perception of efficacy had to use computer related tools in classroom more frequently than others.

This study found no significant influence of lecturer's gender on their perception of utilization of modern technology in teaching of Business Education courses. This finding agrees with Yusuf (2005), who found no significant difference between male and female lecturers in their experience in using computers and other related tools, their level of proficiency in computer operations and their use of common software. This was reflected in the establishment of no significant difference for 15 out of 16 questionnaire items; also, in agreement with this finding is Taiwo (2009), who found that the effects of gender were not significant on the perception of lecturers about the two media options in classroom instructions. Consistent with this work is also the study of Yabatan & Caner (2007), who indicated that there is no significant difference between lecturers responses about the use of educational technology based on their gender.

Not in agreement with these findings however, is the work of Parker Leonie (2002) in Akpan (2010) in their work of cognitive style studies, held that female lecturers are field-dependent and technophobia, while their male counterparts are field independent, and prefer applications of media to instruction.

It was also found in this study that a lot of factors militate against the use of modern technology in the teaching of business courses by lecturers. This is in agreement with the findings of Okolocha (2010) who found that business education lecturers are faced with several challenges in the use of e-learning tools. These problems range from lack of skills and competency on the part of the lecturers, to the high cost of installations, non-availability of electricity, lack of management support among others. Also, in line with this finding, are Malcolm and Godwyll (2008) who saw teachers' confidence in their ICT competence as a major factor for integrating technology in teaching. They noted that if teachers are not confident in their ability or competence to handle computers, this may hinder their willingness to introduce technology in their classroom. This shows us that equipping schools with modern technology is not enough for attaining educational change. The introduction of modern technology into education requires an equal level of innovation in other aspects of education. The inadequacy of the technology courses offered to teachers and the lack of incentives for encouraging technology are further barriers to modern usage. Teachers' attitudes toward computer technologies are also related to teachers' computer competence. Teachers' computer competence is a significant predictor of their attitudes toward computers. Teachers who have difficulty using modern technologies maintained that the main barriers were lack of knowledge and skills with computers that would enable them to make "informed decisions".

Conclusion

From the reviews and discussion of this study, there is substantial evidence that, if modern technologies are placed in the right hands and used appropriately for specific purposes in specific contexts, it can be an effective tool in supporting teaching and learning. However, it is now firmly established that its introduction into schools does not by itself improve the quality of education or raise attainment. Encouragingly, there is growing and widespread awareness that the pedagogical and technical expertise of the teacher is absolutely critical here. In Nigeria, it is clear that the use of modern technologies in delivery of business education courses is an indispensable tool in modern instruction, and so its adoption will enhance quality instruction and enhance functional skill required in work places.

It is important that while thinking of integrating modern technology into our classroom, the lecturers' attitude towards adopting the technology must be considered and training for all must be crucial than ever. To provide graduates with the necessary knowledge and skills for evolving market places and sophisticated living environments and to prepare citizens for

lifelong learning, there is the need to promote quality of teaching and learning through adoption of modern technologies in classroom instructions and improve system management.

Recommendations

From the conclusion drawn, the following recommendations are proffered.

1. In drawing up curriculum for our school(s), curriculum developers should adopt the interdisciplinary approach and emphasis should be on the changing needs of the society through reliance on the understanding and application of new technologies
2. In view of the fact that modern technologies is an influential instrument for the development of quality and functional skills, in educational system, an effort need to be made by government towards creating an educational environment that will be ICT driven.
3. There should be training and retraining of lecturers on the use of modern technologies, which should be both technical and pedagogical by school management, this way, lecturers will show more commitment to its usage.
4. Government should also give serious consideration to the provision of adequate and functional new technologies facilities and infrastructures.
5. For Nigerian education to reap the full benefits of modern technologies in learning, it is essential that lecturers and students are able to use these tools for learning. To do this, Government and Management of Institutions should be visionary about conceiving a future state, which includes the picturing of where and what our education and graduates should be in the future without being constrained by such factors as funding or lack of resources .

References

- Albrecht & Sack (2000). Accounting Education, charting the course through a Perilous future. American Accounting Association. *Education Series. Vol.16*
- Abdelkareem, A.Y (2004). University faculty member's context beliefs about technology utilization in teaching. *The Turkish on-Line Journal of Educational Technology (TOJET) Vol. 3 (4) ISSN: 1303-6521*
- Akpan,U.J. (2010). Teachers' perception of teaching methods in teaching integrated Science: *Unpublished Graduate Diploma in Education Thesis.*
- Dunkin,M.J. & Biddle, B.J. (1974). *The study of teaching*, New York: Holt Reinhart and Winston Inc.
- Faluyi A.E (2002) Title Identification and Validation of competencies needed by Articles in Ondo State Government service. *Unpublished BSc project. UNN.*
- Federal Republic of Nigeria (FRN, 2004). *National policy on Education Lagos: NERC*
- Gulbaharha,Y. & Guven, I. (2008). A Survey on ICT usage and the perception of Social Studies Teachers in Turkey. *Education Technology & Society*, 11(3), 37-51
- Hennessy,S; Harrison, D; & Wamakote,L. (2010). Teachers Factor influencing Classroom ICT Usage in Sub Sahara Africa. *Itupale on line Journal of African Studies. (2) 35-54*
- Inijie,G.O. (2012). Strategies for upgrading the use of information and communication technology in business education. *Association of business Educators of Nigeria Book of Readings, 2(1), 163-167*
- Malcolm, E. & Godwyll, F. (2008) Diffusion of Information communication technology in selected Glaraian Schools. Retrieved on February 20, @www.leeds.ac.uk/edcol/documents/01304.htm
- NBTE(TVET) Report (2010). [http://www.nbte.gov.ng/downloads/Final Reports](http://www.nbte.gov.ng/downloads/Final%20Reports). 17/10/13
- Nwokocha, E.G. & Onwuchekwa, C. A. (2014). A survey of interactive white board (IWB) usage and perception of Business Education Lecturers and Students. *Nigerian Journal of Business Education. Vol. (3), 138-148.*
- Office Technology Assessment (1995). *Teacher and Technology, making the connections.* Washington D.C. U.S. Government Printing Office.
- Okoli, B.E. (2012). A Case for for entrenchment of information and communication technology (ICT) Literacy in the Business Education programme. *Journal of Vocational and Adult Education, 7 (1) 82-87*
- Okolocha,C.C. (2010). E- learning a veritable tool for preparing Business Education Teachers in Tertiary Institutions in Anambra State. *African Research Review. An International Multi-Media Journal. Ethiopia, 4 (4).*
- Otamiri, O. (2014). *Business and technical Education Delivery in the 21st century: The challenge of Quality and functional skills.* A lead paper presented at the 1st annual conference of the Association of Business Educators of Nigeria, Rivers State chapter in Port Harcourt on 14th - 16th May, 2014.
- Pajares, M.F.(1992). Teachers beliefs and educational research. Clearing up a messy *construct. Review of Educational Research. 62(3),307-332*
- Tse-Kian, N. & Mai, N. (2004). Integrating multimedia into the Malaysian classroom: Engaging students in interactive learning. *The Turkish online Journal of Educational Technology (TOJET), 3 (3) 4*
- Ubulom, W. (2014). *Quality and Functional Skills in Technical and Business Education for National Development.* A keynote address presented at the 1st national conference of the Association of Business Educators of Nigeria, Rivers State Chapter in Port Harcourt on 14th – 16 May, 2014.
- UNESCO (2002). Information and communication in education. *A curriculum for Schools and programme for teacher development. Paris UNESCO*
- Wale, J. (2009). *The Journal of American History* 93 (1):117-146

Syntactic and Semantic Behaviour of the Ogba Article, Verb and Pronoun

Ben-Fred Ohia

Federal College of Education (Technical), Omoku
Department of Language Studies
Rivers State, Nigeria

Abstract

Ogba language is one of the over four hundred minor languages of Nigeria. In terms of family grouping Ogba is a sub-language of Igbo which is among the three major languages in Nigeria. Ogba is tonal while English is intonational. The learners from this linguistic Community are most likely to place tone on every syllable rather than spread the tone on a whole sentence. The verb and the pronoun in Ogba language as they are in the English language play vital roles in the use of the language for purposes of communication amongst speakers. It is believed that an understanding of the aspects of the syntactic and semantic behaviour of the Ogba article, verb and pronoun in the teaching and learning of the English language will aid proficiency in the use of both languages. The paper identifies the three major dialects of the Ogba language-Egni, Igburu and Usomini and their mutual intelligibility. The differences that exist in this dialect are restricted to the area of phonemic variation and are few lexical variants; the same affect the use of articles, verbs and pronouns. Therefore, this paper focuses on aspects of the articles, verbs and pronouns in Ogba language in juxtaposition with English. Aspects such as definite article, indefinite article, zero article, tone class verbs, functional verbs, and different types of pronoun are discussed as well as number, case and person. A parallel approach with the English language is used to facilitate comprehension.

Keywords: X-bar, Thematic-role, Argument, Specifier

Introduction

Concept: there is a problem in Ogba linguistic community, the problem of some striking similarities and differences on the syntactic and semantic behavior of ogba article, verb and pronoun with English. This problem according to the findings of this paper has hindered the effective teaching and learning of English in the area. The tutor and learner of English in Ogba linguistic community should recognize the similarities and differences on the syntactic and semantic behaviour of Ogba article, verb and pronoun with English in order to carry out effective teaching and learning of English in this 21st century. He/she should also note the area of problem such as in the articles and segmentals and the fact that the segmentals as well as the supra-segmentals and Ogba differ significantly. The Ogba language (using Egni as the standard dialect) operates a vowel harmony system with [a] as a neutral vowel; unlike English (Ogum 2009).

The Problem of Segmentals and Articles

Similarly, [p] and [f] are English phonemes but in Ogba, they are allophones of the same phoneme in free variation as in

[p] ā p ā [‘apa’] tilapia

and

[f] ‘afa’ [‘afa’] tilapia

The idea of focusing attention briefly on English suprasegmental phonology with a view to underpinning functional communication through the medium of English is that it is rewarding and will facilitate teaching and learning of English. The effective teaching and learning of written English has received significant attention over the years of accommodation of English in Nigeria. The same claim cannot be made of oral English. Some people reckon with oral English as elitist; they perceive it as the sacred object of phonetics and phonology lecturers in tertiary institutions. Sadly, many people dismiss proper articulation of English speech sounds, correct placement of stress, and appropriate use of intonation and masterful control of rhythm as academic pretensions. (Ogum 2000) has cautioned:

Today, English is an international language. People who have learnt its conventions use it. No person, country or race owns it. English is indeed the official language in Nigeria. It is important therefore that we speak the language (and teach it) with a view of attaining national and international intelligibility. Whatever we say is as important as how we say it. Except we say what we intend to say in the correct form, we run the risk of improper communication.

The onus is on the tutor of English to guide the learners effectively to attain desirable oral communicative competence in our school system. This is a major challenge.

The Problem of Articles

The article is one of the areas of English that constitutes a linguistic problem because it is greatly influenced by the mother tongue (L1). In most cases, local transference of vernacular occurs in the non-use of these articles and this constitutes a major problem in the effective teaching, learning and use of English in Nigeria. In delving into this problem of non-use or occasionally, an over use of an article, We have not restricted this paper to the influence Ogba language has on English and vice versa in the context of the Ogba language-English contact situation. The materials for locating the areas where the problem occurs are drawn from some papers written by some Ogba writers, personal letters, sermons given by some Ogba clergy men in some churches in Ogba, dialogues among some Ogba speakers and so many others. This paper attempts to address the problems faced by learners of English in Ogba linguistic community and to proffer solution that will lead to the mastery of English. An awareness of the formal characteristics of Ogba language as well as the sociolinguistic role of English is of a major importance in assessing the relative influence of Ogba on

English. The problem can be assessed only by understanding the structure of Ogba language *visa-a-vis* the various languages in Nigeria and the English language.

The position and function of article in Ogba language is discernible. According to Ohia (2011), “there is one article in Ogba that is not lexically and syntactically used as “the” and “a/an” are employed in the English language”. The fact that the definite article in Ogba language is not used in the same linguistic form does not foreclose its existence.

The Ogba language possesses the definite article that is only known as ‘ya’ and there is zero indefinite article. The definite article ‘the’ in English is used interchangeably with the demonstrative pronoun ‘that’ and the personal pronoun ‘me’ in Ogba language, and in most cases both stand in the same linguistic parlance. This poses a big threat to the teaching and learning of English articles as there is a notable interference of the mother tongue (L1) in L2 class

Examples:

‘Nwa ya’	‘child the’	(the child)
‘Nwa ya’	‘child that’	(that child)
‘Ekw _{oh} ya’	‘book that’	(that book)
‘Ekw _{oh} ’	‘book’	(a book)
‘Nwa’	‘child’	(a child)
‘Nigam Ekw _{oh} ya’		(give me the book)
‘Nigam Ekw _{oh} ’		(give me a book)

The mark difference between the article in Ogba and the articles in English are:

1. The definite article in Ogba performs a dual function as a noun modifier as well as a pronoun.
2. According to the position of adjectives in Ogba, the article ‘ya’ in Ogba does not precede the noun it modifies as in English. The article comes after the noun to conform with the linguistic structure of the Ogba language. In other words an adjective or article is positioned after the noun it qualifies; it does not precede it.
3. Though articles exist in Ogba, it is seldom used; especially the definite article ‘ya’. This is because Ogba is a unique local minority language that is arbitrary and culture bound. It is different from English lexically, syntactically and morphologically. The Ogba definite article ‘ya’ makes the Ogba language (spoken or written) flat and artificial should it be used in the imitation of English. Consequently, it is often arbitrarily avoided in literary essays or speeches.

Examples:

1. “Ome yisi ekw_{oh} ya la’ akwna’ irni” (He will put the book on table)
2. “Je’ ulo je’ ‘eri irni (Go to house, go and eat)

It is observed in the first sentence that ‘ekw_{oh}’ (book) is defined by ‘ya’ (the) but ‘akwna irni’ (table) has no ‘the’ definite article. Also in the second sentence ‘ulo’ (house), the only noun, has no definite article. In English both ‘akwna irni’ (table) in the first sentence and ‘ulo’ (house) in the second sentence should be particularized by ‘the’. In Ogba, to express these two sentences thus:

1. “Ome yisi ekw_{oh} ya la’ akwna’ irni ya” (he will put the book on the table)
2. “Je’ ulo ya je’ ‘eri irni”(go to the house to eat) would sound flat and artificial. This non-use of the definite article in Ogba is often transferred to English by Ogba speakers of English, thereby making it difficult for the hearer to identify the actual substance the speaker refers to. This is a task that must be undertaken by the teachers and learners of English in Ogba.

Aspects of the Ogba Verb

The Ogba verb behaves in a similar way as the Igbo verb because both languages belong to the Igboid group. According to Benneth and Sterks (1977), Bender (1989) in the

classification of African languages, Igbo and Ogba belong to the New Benue Congo Languages. This accounts for the similarity of Ogba and Igbo in tone and accent. Ogba as a tone language has a lexically significant, contrastive but relative pitch on each syllable. Each level of a tone language is a tone-bearing unit (tbu).

The Framework of the Study

The framework adopted in this study is the X-theory. This theory which was devised by Chomsky in (1967) in his article: “Remarks on nominalization” was popularized by Jackdendorf in (1977), X-theory plays a crucial role in syntactic analysis and its essence is to improve on the inadequacy of phrase structure Grammar (PSG).

For proponents of PSG, there can be one possible projection of any category eg.

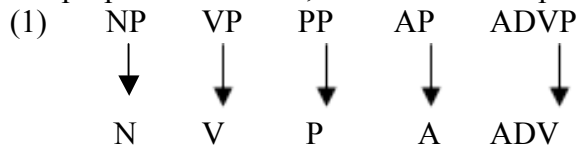

But the proponents of X-Bar theory claim that in addition to the lexical and phrasal levels/categories there can be a possible intermediate category which is larger than the word but smaller than the phrase. The X convention is that each lexical category X defines a set of syntactic categories X, X, X, the subcategories of X of the form X.....X (Jackdendorf 1977:28). The p-structure rule above can be interpreted thus:

X_n= as many bars as contained within the phrase.

X_ny= any subsequent category which is as a result of the subtraction of one category from super category. Therefore, if the super category is X¹¹¹, the following category will be x which is again followed by X¹ and then X.

X- Schema and the Notion of Head.

The notion of head is central in the contemporary syntactic analysis. The head of any maximal projection is the most crucial part of that phrase: Since every phrase contains a head, it is therefore the nucleus of every phrase, because it carries the central meaning of that phrase. The other elements which may occur either before or after the head are its various satellites which specify or limit its reference. A head may or may not take a modifier. Chomsky (1970), proposes the following X-Schema for English;

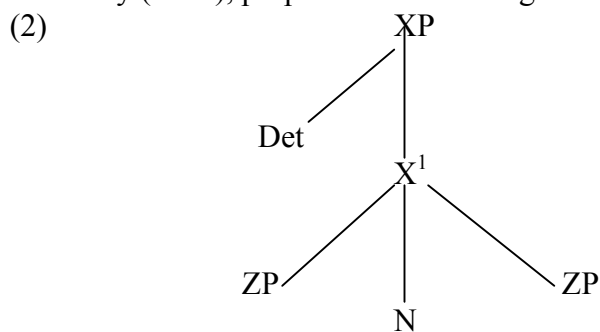

In (2), the specifier of X¹¹ is the determiner, while the argument is what the head can permit. Jackdendorf (1977), revised the X- Schema for English as follows:

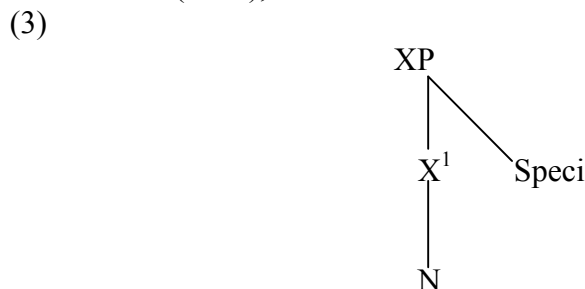

He disagrees with Chomsky over the relevance of the modifier. To him X is the head of the projection, while comp or argument is that category that X can subcategorize for (= can permit). All modes in the X = Schema are optional except for those along the main projection path as in (4)

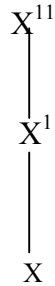

The Relevance of θ -Theory in the Analysis of the Structure of the Ogba Verb.

It is to say the obvious that the knowledge of a language should entail among other things, the fact that a particular verb is a one, two or three place argument verb, and therefore will assign the same number of thematic roles (θ -roles) to these arguments- θ theory was incorporated into syntactic description by Gruber (1965) and Fillmore (1968); studies in lexical relations and the case for case respectively. The idea behind this theory is that grammar should not only provide categorical information, but also thematic information regarding lexical entries. Suffice the following:

- (5a) The categorization feature for the verb murder is ‘murder’, (X V).
- (b) The sub-categorization frame for the verb ‘murder’ is ‘murder, XV (-NP) e.g. murder somebody.
- (c) The selectional restriction frame for the verb ‘murder’ is: < HUMAN- HUMAN >
- (d) The thematic frame for the verb murder is: < AGENTS > < PATIENT> JOHN murdered Mary. >.

Theta roles are essentially semantic properties and are assigned to argument positions (A-position henceforth).

A- Positions often coincide with the positions for nominal elements which may be nouns or pronouns, e.g.

- (e) JOHN murdered Mary
- A-position A-position

A-Position cannot be assigned θ -roles because they are non-argument positions.

There are two types of argument, namely: Internal and External arguments:

Internal Argument

Internal arguments are objects of the verbs. The verb being the case assigner, assigns case to its internal argument, the object.

External Argument

External argument is the subject with the INFL as case assigner and the verb as a theta assigner. There are number of θ -roles that have been identified in syntactic theory. But we must also remark that the number of θ -roles assigned to A- proportion is finite. Each argument bears one and only one θ -role, each θ -role is assigned to one and only one assignment.

(Sells 1985: 37). The following are θ -roles

- (i) AGENT (5)
- (ii) THEME (0)
- (iii) LOCATION ()
- (iv) SOURCE (E)
- (v) GOAL (N)
- (vi) PATH (X)

θ-Roles can also be expressed in a number of semantic dimensions. Thematic relation plays a very crucial role in syntactic analysis. Fillmore (1968) and Radford (1988) have both agreed that constituents of the sentence that are thematically compatible cannot be conjoined.

The Centrality of the Ogba Verb.

The verb is an obligation element in a sentence in the Ogba language as it is in any human language. By this assertion, it means that the verb is the nerve centre of any sentence in Ogba language. The verb is the most prolific word class in Ogba land. In fact, from available facts about Ogba morphology, it suffices to say that word derivation is unidirectional in the list, i.e. from the verb to other word classes. The Ogba verb performs a lot of sentential functions which are performed by other classes in some other languages.

In Ogba, the dearth of free form lexical classes to express certain notions, as we often find in some other languages, is augmented by the verbal class.

The Classification of Ogba Verbs

The parameters for the classification of Ogba verbs are as follows:

Classification by Tone

The Majority of Ogba verbs are bound roots, i.e., they often require the presence of other bound elements when they occur in verb forms. Because of the bound nature of the Ogba verb roots, it is often difficult to determine their inherent tones when they occur in isolation. So the tonal group of any Ogba verb is determined due to its behavior under the infinitive verb form. This split has necessitated the classification of Ogba simple verb roots into tone class I and tone class II. The tone class I verb roots are described as high tone verbs, while the tone class II ones are described as low tone verbs apparently in the infinitive verb form. Nwachukwu, (1983) and Emenanjo (1978) worked on the infinitive verb form in Igbo. The tone class I verbs show a high step tone pattern, while the tone class II ones show a high-low tone pattern as can be seen below:

Tone Class I Verbs:

- (a)-gnu 'read' 'Count' i = ignu -'to read, Count'
- (b)-gba 'run' 'Shoot' i = igba- to run, shoot'
- (c)-rii/ri 'eat' Crawl i = irii, iri- to eat, crawl'
- (d)- bu 'Carry, i = ibu- to carry'
- (e)-zah 'Answer i = izah to answer'.

Tone Class II Verbs

- (a) boh 'dissect' i = iboh- 'to dissect'
- (b) zaa 'sweep' i = iza -'to sweep'
- (c) zno 'rain' i = izno -'to rain'
- (d) di 'endure' i = idi - 'to endure'
- (e) dih 'present' o = odih- 'to be present'.

There is a third class of Ogba verbs with high down steps. Such verbs to Ohia and Onyedibia (2003) are in some Ogba dialects such as Idu Osobile and Idu Obosiukwu.

Functional Classification

There are two distinct groups of verb in human language: verbs that have no distinctive grammatical function but with definite referential meaning and those with particular grammatical function but without referential meaning. The first group is known as lexical/main verbs, while the second is called auxiliary verbs. Emenanjo (1986), notes that auxiliaries in Igbo are verbs which require and/or infinitives to complete their meanings (i.e. complements). He lists the auxiliaries that are used in standard Igbo in spite of some of them being essentially dialect forms. The same qualifies Ogba auxiliaries- mū, lá (will, is).

The Notion of Transitivity in Ogba

There are two conflicting schools of thought as to whether transitivity is a relevant term in Igbo. Emenanjo (1975, 1984 and 1985) agrees that transitivity is a redundant feature in Igbo syntax, basically because every Igbo verb is used with a noun at the deep structure. His argument for the non relevance of transitivity in Igbo is that the language lacks passivization. He argues that in English all transitivity verbs can be passivized. But Nwachukwu (1983, 1987) attempts to dismiss Emenanjo's assertion as he believes that the fact that passivization is not possible in a language does not rule out transitivity. He contends that a verb is transitive if action transits to its object, whether the object is a bound cognate noun or not.

The object of a transitive verb is the patient if it is totally affected by the action expressed by the verb. The group of verbs referred to as motion verbs are not transitive in any way. In the same vein, motion verbs in Ogba, as they are in Igbo, are generally associated with a preposition involved. Therefore, in spite of the surface discrepancies of motion verbs in Ogba, they must be analyzed as sub-category for a PP complement and not transitive.

Examples are:

(14a) o jeere w_{oh} órnū - They went to farm.

(14b) unu siga la ul_{oh} eje ul_{oh}-ekw_{oh} som - Do you go to school from home?

Although the P_P complement is omitted in certain dialects of Ogba, giving the impression that motion is omitted in certain dialects of Ogba and that motion verbs are transitive. It is generally agreed that the occurrence of the optional preposition (lá) in constructions which involve motion verbs does not cause ungrammaticality as (14a and 14b) above show.

Ndimele (1992) working on Etchie verb which is also igboid, says Etchie verbs show a significant contrast to Emenanjo's claim that all Igbo verbs are transitive. Some Etchie verbs can be inherently intransitive; in which case they do not subcategorize for either an overt or covert NP to their right. Therefore, since every nominal position must be theta-marked and assigned case, Emenanjo's conception of verbs that take as transitive is quite unrealistic.

Every language has its own parameterized variations, its own special characteristics and traits; therefore, passivization is not a most important criterion for determining transitivity. What determines transitivity, as noticed in Ndimele (1987) is not only when an object in a language takes θ -role of a patient. The action of the verb can pass from an Agent(s) to a goal (n) and yet the verb is regarded as transitive.

Example (15) clarifies these:

(15) O jeere órnū - He went to farm.

Secondarily, it is not sufficient to generalize the notion that Igboid lects use the so called optional preposition. One thing is worthy of note in the above argument, and that is while the verbs in some Igboid lects are not transitive; they seem to be semantically hollow when used without complement. Moreover the meaning of most verbs in Ogba is seen as semantically empty but for their complement which carry the meaning of the construction.

Example:

(16a) bu ibu - "be fat"

(b) bn_u egwu - "Sing a song"

(c) kw_u ek_{ah} - "Clap your hand"

With the availability of some theoretical resources since the late 1980s, the issues of transitivity can potentially be significant, constrained and greatly simplified. Debates regarding transitivity in Ogba as presented here can be taken care of by our present understanding in linguistic studies. Argument structure now specified the number of argument that a predicate (Verb) takes, thereby eliminating the problem posed by

transitivity. Such arguments are explained by one-place Argument Verbs, Two-Place Argument verbs, Three-place Argument verbs and Four-place Argument verbs.

Examples:

One-place Argument verbs

(17) Ngozi wnumala (Ngozi died-fact)

Two-place Argument verb

(18) Emeka Kpo wori Emelike (Emeka called Emelike)

Three-place Argument verb

(19) Obi zuni Ada ewu (Obi bought a goat for Ada)

Four-Place argument verb

(20) Eze nigra Obi ego maka ihiri-kem (Eze gave Obi money on my behalf).

Further Steps

While our focus in this paper is on the relationship between Ogba article, verb and pronoun, we observed some differences and similarities between them and those of English in Comparison. In addition, the semantic relatedness and non relatedness of the articles, verbs and pronouns in the two languages account for the performance of English speakers from Ogba Linguistic community. The next step of this paper will focus on “The word class effect in Ogba Language”. The new paper will discuss the noun, preposition, adverb, etc and the role word class information plays in lexical access in Ogba Language and English. Of Central importance in that paper is the question of whether word class effects arise at the lexical-syntactic or semantic level. This is not travail because it has been demonstrated that word class variable correlates with semantic variable-such as imageability. For example, it is a known fact that nouns tend to be more imageable than verbs (Chiarello, Shears and Lund, 1999).

Conclusion

Nigerian Teachers of English and Teachers of English all over the world are depended upon to produce a generation of competent users of English for academic and other purposes in this 21st century. We must not fail. It is said that no nation can rise beyond its educational system and no educational system can be better than the quality of the teachers who operate the system.

Earnestly, this paper observes that a marked problem exists in the usage of article by some Ogba speakers of English. The necessary or redundant use of the definite article, is not as pronounced as the non-use of it due to the non-existent of the indefinite article. The confusion in its usage and the substratum influence are thought provoking. Though the articles appear to be relatively insignificant words in English, they are grammatical tools. Their function is to facilitate the use of the language and therefore should be skillfully handled. If English as a second language must maintain its international standard in Nigeria, such particles in the English language use should be skillfully taught in our educational institutions irrespective of any level.

Similarly, a sizeable amount of data that the Ogba verb in controlling word class in the grammar of Ogba as in other languages of the world has been shown. It regulates the behaviour and distribution of some other word classes, particularly the nominal class. The verb also serves as the host for such secondary grammatical categories as tense, mood, aspect, negation, etc. The Ogba verb can be used to express certain notions in some other languages such as English will be expressed by some certain other form of classes.

In classifying Ogba Verbs, we have used four parameters namely: tonal, functional, semantic and formal. The Ogba verbs were also divided into two groups: those that have no distinctive grammatical function but with definite lexical and those with particular grammatical function but without referential meaning (auxiliary verbs).

Semantically and morphologically, we have classified and grouped verbs into stative and non-stative verbs and simple and complex verb forms respectively.

The paper notes that the question of transitivity which is a traditional notion is no longer valid and could be re-examined with the availability of certain improved theoretical resources among which are the case theory, θ -theory and X-theory. The issue of transitivity by our present understanding has been reduced to the argument structure of the predicate containing such verbs. Using this criterion, therefore, we have grouped Ogba verbs according to the number of Argument they take. This, if followed will facilitate the effective teaching and learning of English in Ogba linguistic community.

If this paper makes any sense to the audience, then authors of other linguistic communities should advice on ways to improve and make concerted efforts towards ameliorating this linguistic problem that mars the effective learning of the English Language as an International Language. Such efforts will increase the learning capabilities of Local users of English in the area of improving on articles or inclusion of articles, verbs and pronouns in their native languages.

References

- Bender- Samuel, J. T (ed.) (1989). *The Niger-Congo Language*. Maryland: American University Press in Wycliffer Bible Translation/Summer Institute of Linguistics.
- Chiarello, C., Shears, C., & Lund, K. (1999). "Imageability and Distributional Typicality Measures of nouns and verbs in Contemporary English." *Behaviour Research Methods Instruments and Computers*, 31, 603-637.
- Chomsky, N. (1967.) "Remarks on Nominalization" in Jacob R. and P.S. Rosenbaum (Eds) *Readings in English Transformational Grammar* Mass: Ginn and Co.
- Emenanjo, E. N. (1975.), "Aspects of the Igbo verbs" in *Igbo Language and Culture* Vol.1. Ibadan: Oxford University Press pp 160-173.
- Emenanjo, E. N. (1978). *Elements of Modern Igbo Grammar*. Ibadan: Oxford University Press.
- Emenanjo, E. N. (1984). "Transitivity or complementation" paper presented at the 5th Annual Conference of Linguistics Association of Nigeria, held at the University of Nigeria, Nsukka.
- Emenanjo, E. N. (1986). 'Igbo Verb Complement and the Argument structure of Complement Linguistics, Igbo 260 Talk' Harvard University.
- Greenberg, J. (1963). *Classification of African Languages*. London: Oxford University Press.
- Gruber, J. S. (1965). "Studies in Lexical Relations". Doctoral dissertation, M.I.T., Cambridge, Massachusetts, Published By Indiana University, Indiana.
- Gruber, J. S. (1990). *Complex Thematic Structures* M.I.T Massachusetts.
- Ndimele, O. M. (1987). "The Morphology of Etchie Language". M.A. Dissertation, University of Port-Harcourt.
- Ndimele, O. M. (1992). *The Parameters of Universal Grammar: A Government- Binding Approach*. Owerri: African Educational services.
- Ndimele, O. M. (1996). *An Advanced English Grammar and Usage*. Aba: National Institute for Nigerian Languages.
- Ndimele, O. M. (1999). On the Phonosyntactic Dimension of Negation in Emananjo, E.N. and Ndimele, O.M. (ed.) *Issues in African Languages and Linguistics, Essays in Honour of Kay Williamson*. Aba, National Institute for Nigerian Languages.
- Ndimele, O. M. ed. (2011) *Orthographies of Nigerian Languages: Manual IX*. Abuja: Nigerian Educational Research and Development Council.
- Nwachukwu, P. A. (1983). 'Towards a classification of Igbo verbs' in Nwachukwu, P.A. (ed). *Readings on the Igbo verbs*. Onitsha: African Publication of the Igbo Language Association.
- Ogum, D. N. (2003). *The Phonology of English*. Port Harcourt: Abe Publishers, Ltd.
- Ogum, D. N. (2009). "Phonetics: Stress, Intonation and Transcription". A Workshop Paper on the Effective Teaching of English by Total E&P, Nigeria Ltd.
- Ohia, B. F., & Onyedibia, H. O. (2003.) *The Ogba Nation 1460 -2003 Vol.I*. Port-Harcourt, Charlesworth Publishers Limited.
- Ohia, B. F. (2011) "The problem of 'Articles' Among Ogba Speaking Students of English". *International Journal of Language and Communication Studies Vol.4 Nos 1&2*, Ikot Ekpene, Akwa Ibom State, Nigeria (Pp. 114-119).
- Ohia, B. F. (2012). "Aspects of the Syntactic and the Semantic Behaviour of the Ogba Verb". *Nigerian Journal of Gender and Development: An Interdisciplinary Journal Vol.12 Nos 1&2*, Adeleke University, Osun State, Nigeria (Pp. 40-51).
- Omekeh, A. & M. Umukoro (2009). "The Pronoun and its Usage in Isoko Language". *Journal of Languages Vol.4* College of Education, Warri, Delta State, Nigeria (Pp. 155-161).
- Quirk, R. & Greenbaum, S. (1973). *A University Grammar of English*. Singapore: Longman.

- Radford, A. (1988). *A student's Guide to Chomsky's Extended Standard Theory*. Cambridge, Cambridge University Press.
- Uwalaka, M. A. (1997). *Igbo Grammar*. Ibadan: The Pen Services.
- Westermann, H. (1997). *Classification of West African Languages*. London: Oxford University Press.
- Williamson, K. (1977). *Reading and Writing Ogbah: Rivers Readers Project*. Port-Harcourt: Goodwill Press.

The Parameteric-Effects of the T-Movement, PSG and X-Bar Syntax on English and Ogbah

Henry Oburu Onyedibia
Federal College of Education (Tech) Omoku
Department of Language Studies
Rivers State, Nigeria

Abstract

Recent research outcomes in the field of linguistics have triggered a lot of reactions in the forms of contrastive syntactic investigations. These moves have in no small ways radicalised and revolutionised the approach to language appreciation. Some of the linguistic research results in these breakthroughs are the Phrase Structure Grammar, Transformational Movements and the X-Bar theory or syntax. This work examined the holds of some of these popular notions of modern grammar on language, especially the cross-linguistics relations which they may possibly hold for English and Ogbah. The major area of concentration is the parameteric consequences on the languages of study in terms of the universal parameters and the exceptional features which the Ogbah language holds against the English language sets. This paper argued that the Ogbah language shares some universal and peculiar parameters in the three selected areas of this paper. It ventured a contributory boost to the descriptive notion of grammar relating to Movement, Phrase structure rules and the modification made to the “flat structure” of phrase structure grammar. In this paper, it has been shown that the Ogbah language holds some grammatical differentials which knowledge could assist in strengthening the modern grammatical unfolding in the sphere of descriptive linguistics learning and teaching.

Keywords: Parameter, Transformational-movement, Phrase structure grammar, X-bar syntax, head.

Introduction

Language is one of the dynamic indexes possessed by human. The development of this notion was stalled from manifestation for many years, until the advancements in human language studies made by Harris, Bloomfield, Chomsky, etc. The evolution of the Phase Structure Grammar (PSG), Transformational Movement (T-Movement), X-bar Syntax, and the Principles and Parameters theory have triggered investigations on various aspects of language based on the descriptive approach. The outcomes have been revolutionary. The massing investigations on the world's natural languages triggered by the revolutionary principles and parameter theory will be a major trigger to this paper. In other words, the locus hinges on the idea that the Ogbah language (a natural language spoken by the Ogba people of South-South Zone of Rivers State in Nigeria) could hold many differentials in the areas of the Phase Structure Grammar, Transformational Movements and the X-bar Syntax. . Radford (2004) agreed that knowledge of these parameteric implications enables the child learner to know which one of the language sets that fits the acquisition intendments. Even for the language teacher, such comprehension is mandatory.

Literature Review

Foundation Problems of Language Learning and Teaching

A wise saying has it that a teacher is a good reflection of the educational quality of his nation. It then follows that the learners of language, especially at the secondary school and tertiary levels may not exhibit more than has been transferred to them by the teachers of language. This research has identified the persistency of prescriptive grammar as an unrelenting setback to the knowledge of language realities.

The Phrase Structure Grammar (PSG)

Matthew (1993:111) noted that upto the 1940s, there were two major tasks bordering syntax: "One to establish the hierarchical structure of sentences and the other to sort the units of the hierarchy into classes with equivalent distribution". Chomsky (1957) agreed that "customarily, linguistic description on the syntactic level is formulated in terms of the constituent analysis or parsing (in Matthew, 147). Lyon held Chomsky's contributions to the phrase structure grammar as "...original, and probably most enduring contribution to linguistics as the mathematical rigour and precision with which he formalized the properties of alternative system of grammatical description". This according to him "was his formalization of phrase structure grammar".

The structure of a phrase may differ from one language to another, especially the 'noun phrase' and 'verb phrase' (Palmer 1971:76). Radford (1999:390) posited in support of Palmer's preposition that two languages may emerge according to the position of the grammatical value represented by "Specifier"(Speci.). Specifier (The, an, a etc) situated left to X^1 is phrase initial and vice versa. In Ogbah, the specifier is right to X^1 in regard of the noun phrase; as illustrated in the schema below: 1.

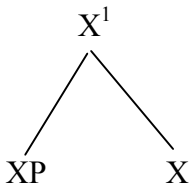

Consider this Ogbah example relating to the position of the Specifier to X.

2. e. g. Nwoko ya
 Man the
 “The man”

The specifier, Ya (“The”), is located rightmost to a lexical in Ogbah syntactic structure. In the phrase structure grammar (PSG), there are two known levels of phrasal constructions; the first given as NP,-VP, etc and the second in the notations N, V Adv, Adj (Onyedibia, 2010:40). Ndemele (1992:29) noted that there are two “ultimate categories” within the PSG - The “lexical categories” and “phrasal categories”. The PSG, he affirmed is blank on “intermediate levels”. As we shall see later in this paper, the intermediate levels, lacked by the “flat structure” of the PSG, remains one of the majors reasons for the intervention of the X-bar syntax.

Noun Phrase

In Ogbah language, the Specifier could be a determiner, article or demonstrative pronoun. In English language, it is obligatory that the specifier should precede the noun it modifies; which means that it is phrase initial. The Specifier, in Ogbah is phrase final as well as the complement. In the NP structure: ‘Umu isi ikne ka Jon ya’, the Specifier ‘ya’ (‘the’) occurred at the final position of the Noun Phrase, adjacent to the complement ‘ka Jon’ (‘of John’). In English language, the articles ‘a’, ‘an’ and the determiner ‘the’ are respectively obligatory precedents of the heads of Noun Phrases mainly as factors of specification and convention. This assertion is illustrated with the schema and examples below:

3. i. The thieves of Omoku.

Det + N + (Pp)

- ii. A Man of honour.

Det + N + (PP)

- iii. An ugly boy in Lagos.

Det + Adj. + N + Pp

In the Ogbah language, the articles above are not obligatory constituents of the Noun Phrase. Remember that Ogbah is a Specifier phrase-final language. In this case, the Specifier is totally absent, contrary to English in which the occurrence of any of these items with some nouns is obligatory. Note that nouns such as Peter, Mary, John, Uche, Oburu etc cannot take any of these articles or even demonstratives except ‘this’ and ‘that’ (That John.... This Peter....). Let us examine the specific instances where the uses of these items are not obligatory, using the above sentences’ equivalent in Ogbah:

4. i. Nde osni ka Omoku

Pm +N + (PP)

“The thieves of Omoku”

- ii. Nwokno Oma

N + Adj

“Good man.”

- iii. Nwatakri ya amawoh nma dila Lagos (High tone on the initial ‘a’ in ‘amawoh nma’) – The ugly girl that is in Lagos.

N + Adj + (PP)

The sentences above have no articles; unlike the case in English. These concern the occurrences of multiple adjectives in the noun phrase. Consider the examples below:

The huge black woman on the white door

Det +Adj. + Adj. + N +Prep +Det +Adj. +N

Nwayna ukwu oji ni dila akhu ocha ya
 N + Adj. +Ad +Det +Prep + N + Adj.+ Det

5. i. A dirty old woman
 D + Adj. + Adj. + N

ii. Owhnu agadi nwayna irno
 Num + Adj. + N + Adj.

The structure of Ogbah Noun Phrase is more complex, compared to that of English language. This is due to the multiple copulation of morphemes which exhibit varied syntactic functions. Consider these examples:

- a. Those handsome boys.
- b. ‘Umutachi nwokno ndeya mranma’

Verb Phrase

In Ogbah, intransitivity in relation to the verb is a rare occurrence. This is because the grammar does not permit verb stranding. Almost every verb has an imbued complement. This may be due to the graphic description of Ogbah verbs, which makes them to be self- explanatory. It may be in the form of tone, tense or enclitic. All these make it impossible for the Ogbah verb phrase to permit intransitiveness. Let us observe how this applies to Ogbah. Consider the verb ‘bu’ (carry):

6a. Bu (?)

- i. bu li – carry up
- ii. burula – has carried or carried it
- iii. buje – carry to
- iv. buvyna – carry in 5. busno – carry down
- v. budna – lower down

b. kwu (?) (Inherent meaning)

- i. kwuru – fetch(liquid)
- ii. kwuje – continue to say (talk)
- iii. kwuni – say to
- iv. kwudna – backbite
- v. kwuli – beat up or say it loud
- vi kwuknini – say it (now)

Below is the applicability of the examples above.

7. i.

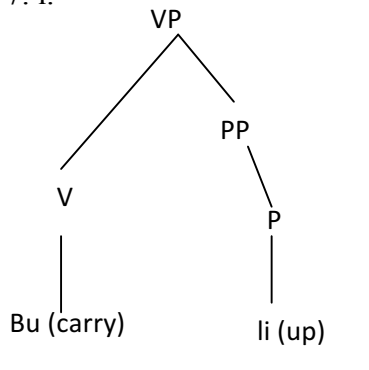

ii.

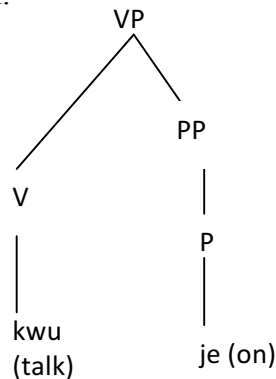

This inherent nature of some Ogbah Verb Phrases is not obtainable in English language. We can expand the structures further by arguing that the structures can take object complement and adjunct. Another difference between the Ogbah verb phrase head and that of English is the contentedness of the former. This means that the verb has tone, tense marker and enclitic. Let us again use the verb ‘bu’ and see how the features are entailed.

Burula

Bu ru la
Carry -ed has
“Has carried”.

In Ogbah verb phrase, the adverb (adjunct) occurs mainly right of the VP head, contrary to that of English which is left driven and in some cases at the right of the verb. Consider the following schema:

8a. VP → V+ADV = Jjere knikne
went quickly

Ri osiso
Ate fast

b. VP → ADV + V=* Knikne jijere
quickly ran

In Ogbah, the past form of the verb, usually does not co-occur with some adverbs. The following verb phrases which have their heads co-occurring with some adverbs such as, always, frequently etc are ungrammatical in Ogbah:

9. i. Kissed his mother-in-law frequently (Carnie lbid:73)
- ii. Stabbed his mother always

Let us find out how these would be in Ogbah.

10. i. * Snusnusi nneogo a onu osangbe
- ii. * Tiri Onakwuwoh nma osangbe

The presence of the adverb ‘Osangbe’ in the two phrases for Ogbah makes them ungrammatical. Their removal will make both VPs grammatical. Does it mean that Ogbah VP does not accept an adverb as adjunct? Let us see how these structures would be when the adverbs are governed by the simple past tense (the historic).

“Kisses his mother-in-law frequently”

11. i. Snusnusi riga nne ogo a onu osangbe.
Kiss -es(enclitic) mother inlaw his mouth often.
- ii. Snusnusi ga nne ogo a onu osangbe
Kiss -es mother inlaw his(enclitic) mouth often

The grammaticality of 2(a) and (b) confirms the claim that the past form of a main verb (head of a VP) does not co-occur with certain adverbs. This is not the case in English as we have observed above.

Prepositional Phrase

Madugu (1995) and Mbah (1999) noted that “category incorporation has been argued...to be a feature of West African languages...” English language prepositions are very obvious, especially, in the sense of a word not performing variegated functions in different phrasal or clausal contexts. This is not the case in Ogbah in which a word can at different syntactic contexts have varied values. This capacity is a common feature of Ogbah language as we have earlier noted.

Lexical Preposition:

Ime (inside), Usor (side), la (to), la (at), elu (up), ali (down - not earth), ime (in-not pregnancy), whe(cross -not worship), Ogologo-ogologo (along); whe (cross), pia (come out) etc.

Bound Prepositions:

12. ‘Ni’ O gbu ni mu ewu.
 cl kill for me goat.
 “He/she has killed goat **for** me”.

‘Re’ O gusire mu egwu ogor.
 cl played me joke bad.
 “He/she played roughly with me”.

In Ogbah, it is the bound affixed morpheme which carries the notion of preposition. One test to confirm the validity of this claim will be based on the “adjacency principle” which requires prepositions to be immediately adjacent to the predicate nominal it dominates. Following the above claim, it is safe to assert that English language has no bound prepositions at least in “-rV-rV” notation. Another type of prepositional phrase which English lacks is the one realised through rank shifting by Re-analysis of the semantic value of one of the co-operating phrasal items. Mbah (1999:176) called this “category incorporated preposition”. He notioned that “lexical categories...bind into a compound...of which one of the elements loses its categorial status by reanalysing its meaning”.

In Ogbah, unlike the English compound or the “compound” which Mbah insinuated, the incorporating categories result to a phrase. This is because such construction has clear phrase meaning different from the sense of a compound which commonly makes one sense. Some of the prepositional phrases which can be realised by rank shifting and semantic reevaluation are as follows:

<u>D – structure</u>	<u>S – structure</u>
13. i. Kphne je Climb go	climb up (go)
ii. Je je Go go	hurry up
iii. Bu li	carry up (li)

Note that the verbs preceding the re-analyzed verbs (prepositions) are prepositional modifiers, and that re-categorized words should always take the appropriate objects. The verb is obligatorily an integral part of this type of prepositional phrase in Ogbah. This is not the case in English Language. One test to confirm that in re-categorization by incorporation, the preposition is the governor of the modifying verb, is to consider the case of rank-shifting as it concerns the adjectivised noun. Consider the examples below:

- 14a. Bookcase = Bring the book case (A type of case).
 ▼ ▼
 noun noun
- b. Mail box = I have a mail box (A type of box).
 ▼ ▼
 noun noun

‘Case’ and ‘mail’ are re-categorized to mean adjectives which specify the type of ‘case’ or ‘book’. As much as ‘mail’ changes to adjective to describe the noun ‘box’, ‘Book’ and ‘Box’ are therefore subjects of the adjectivised nouns.

Ogbah prepositional phrase does not allow intervention between the head and its complement. The determiner 'the' and possessive 'my' intervened between the prepositional heads of the phrases and their objects as can be seen in the English sentences and the tree diagram below.

15. a. In the afternoon of yesterday. b. Behind my room.
La eti ehne ka uynahnuru. Aznu uloh kem.
 "\"In the noon of yesterday\"\". Back house my
 \"\"Backyard of my house\"\".

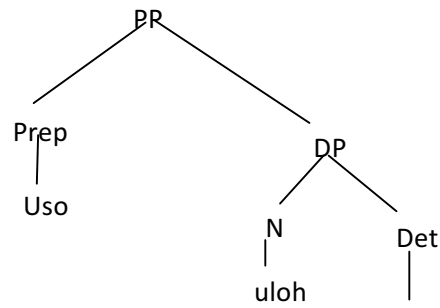

In the Ogbah phrases above, it is clear that there are no items intervening between the heads 'Uso' and the object 'uloh'; between 'uloh' and the adverb, 'etiehne'. For Ogbah, the non-intervention of any item between the head and adverb, determiner or noun is an obligatory syntactic adherence. Mbah (1999:173) noted that in English, the intervention of any of these items between the head and its object in a prepositional phrase is obligatory. In Ogbah, this is conspicuously absent; meaning that it is not an obligatory component of the Ogbah prepositional phrase. All definite and indefinite items for specific/non-specific references are not permitted to occur between the head and its referent, or even preposed on another site within the phrase. One other variation is the prepositional placement of the possessive determiner 'kem' ('my') right of the object of the phrase head. Unlike the articles, the possessive pronoun (determiner) etc is an obligatory lexical constituent of the prepositional phrase when the structure in which it occurred is translated to Ogbah. The position is however altered to follow the lexical item preceded by the head of the prepositional phrase. It is the same with all possessive pronouns having determiner functions.

Transformational Grammar

Carnie (2007:285) admitted that the X-bar theory is movement barren. To enable these movement incidents, the transformation rules were introduced. Chomsky noted the three "models of linguistic description" as "finite-state grammar", "phrase structure grammar" and "transformational grammar". The transformational grammar model is the most powerful, and holds appropriately adequate "principles to serve as models for the grammatical description of natural language" (Lyons, 127). In Chomsky's *Syntactic Structures* (1957), he proposed a corporate theory of grammar referred to as Transformational-Generative grammar. The generative aspect of the theory seems to have been accommodated in the phrase structure grammar, which accounted for the phrase structure constituent analysis; its decompositional capacity and recursiveness.

Inflection-to-Complement Movement (I →C)

This type of movement is prelude to the realization of ‘direct question in English language.’ The mobility operation here pertains to the removal and raising of an obvious property of Inflection to the Complement positions outside the surface structure construct (S-structure). The syntactic approaches of insertion and movement can be used to realize direct questions in Ogbah. In using the insertion method, the sentence is considered unaltered by transposition of the construct’s word order. Consider the schema below.

16. [Jon mhe je uloh] (‘John will go home’)

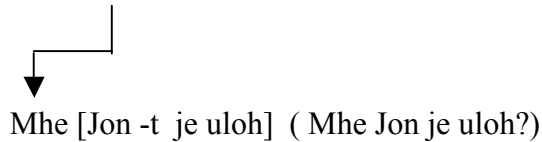

The resulting S-structure is ungrammatical because in Ogbah, auxiliaries (which are very few) do not precede certain grammatical items, especially nominal as a matter of rule. This is why inflection movement cannot transpose itself on barriers that are sentential. A way of resolving this impasse is to assume that the bound root complement ‘wnala’ is located at Specifier-C and would lower to I and prepose on the auxiliary ‘mhe’ (‘will’) to achieve ‘mhewnala’. This is demonstrated in the tree diagrams below.

17a. Jon mhe je uloh
 John will go home
 “John will go home”

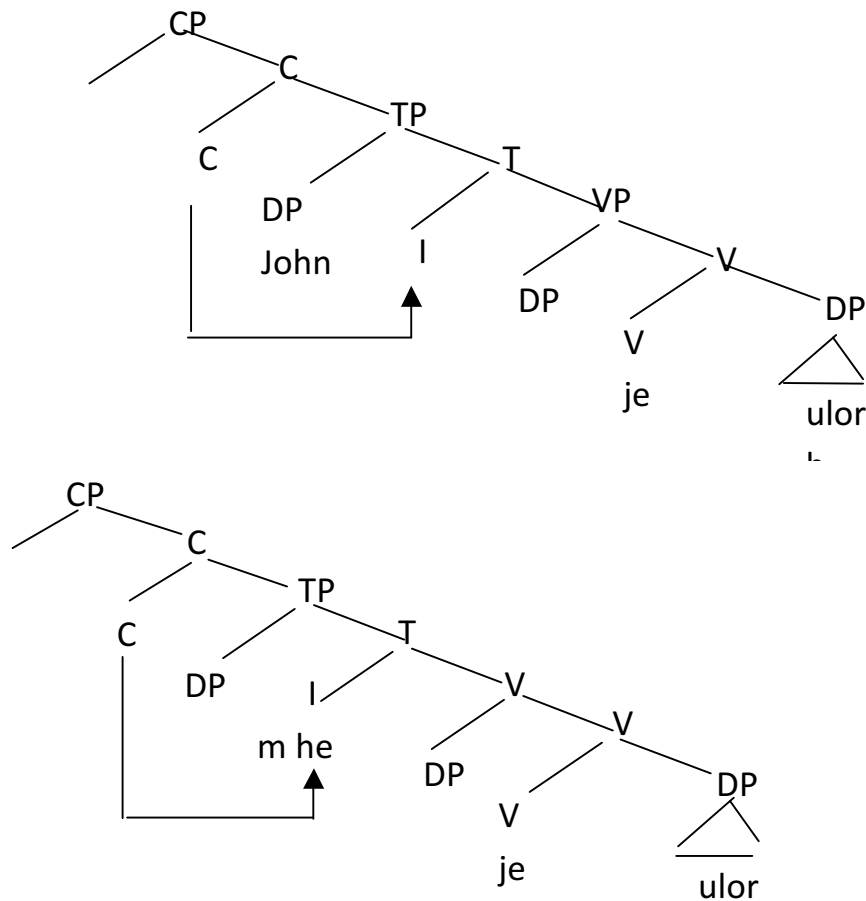

Under this consideration, it will be adduced that for the realization of direct questions in Ogbah, one way is to lower the bound enclitic root ‘wnala’ to I in order to achieve the Ogbah pro-future auxiliary ‘mhewhnala’ (‘will’). In English, the realization of this, is a matter of syntactic movement of I to Specifier – C. Radford (1988:411) noted thus:

What we shall argue here is that in such cases the italicized modal ‘will’ originates in the I position within S, and S subsequently moved into an empty C position...by a rule we might appropriately call I Movement (or precisely I – to – C movement). Obviously, the I movement analysis is based on two key assumptions: (i) inverted modals like ‘will’ originate in I, and (ii) they end up in C.

This is not the case in Ogbah where Specifier C would have to lower to fill I. This is very possible considering that I is strong in Ogbah, but weak in “Modern Standard English” (MSE). According to Radford et al (2002:245-347)

... a further parameter of structural variation between languages (which we might refer to as the INFL parameter) relates to whether INFL is strong or weak...this too turns out to be binary (in that INFL can be either strong or weak – It cannot be both or neither. In EME, Early Modern English, INFL and C are both strong, whereas in MSE, Modern Standard English, INFL is weak but C (in questions) is strong.... This means that it, INFL, doesn’t have to be filled.

This principle of INFL and C parameter could be accountable for the inability of C to be filled by I-movement to C in Ogbah. The immobility of the INFL ‘mhe’ to Specifier-C constrains the realization of direct question in Ogbah, which could only be achieved by lowering the bound morpheme ‘wnala’ to I which is strong in Ogbah. The movement of C-to-I conforms to the requirements of the “Head Movement Constraint (HMC)” proposed by Lisa Trevis. It states that:

“... a constraint... imposes restrictions on how grammatical operations work,” and that “A moved load can move only into the head position in the next highest phrase containing it (Radford et al, 346).

To lower C-to-I in Ogbah could be an extension rather than reversal of the HMC rule. However it is necessary as matter of last resort. In this regard, Carnie (2007:260-1) noted that the ability of INFL to move to C in English is as a result of, “... the presence of a special null question complementizer”. The initiation of ‘wnala’ from C-to-I is therefore a matter of syntactic parameter which is adoptable in Ogbah, but grammatically ultra vire in English. Some Ogbah questions can also be realised, not by the ruled out subject-aux inversion (I-to-C movement) but by insertion or the ‘som’-support. In English, certain grammatical constructs are constrained from question formation by inversion or moving the inflected verb around the subject. This pertains mainly to auxiliariesless structures.

Radford et al (1999), apart from recognizing the un-grammaticality of this type of construction, also faulted the movement leading to its realization as a clear violation of the HMC economic principles. The movement is adjusted to the tenets of the rule since HMC rules out the possibility of a main verb moving directly from V to C, because the verb would be moving too far in one go. Despite the conformity of the V movement ‘restrictions’, the overriding nullity is that, INFL being weak in MSE cannot be filled because “any move to fill it is unnecessary”. To

overcome this problem, it is further suggested that the ‘dummy’ auxiliary ‘do’ will emerge from INFL and raise to fill Specifier C which is strong in Modern Standard English. Consider the following tree diagrams:

18.

“Does he enjoy it?”

a.

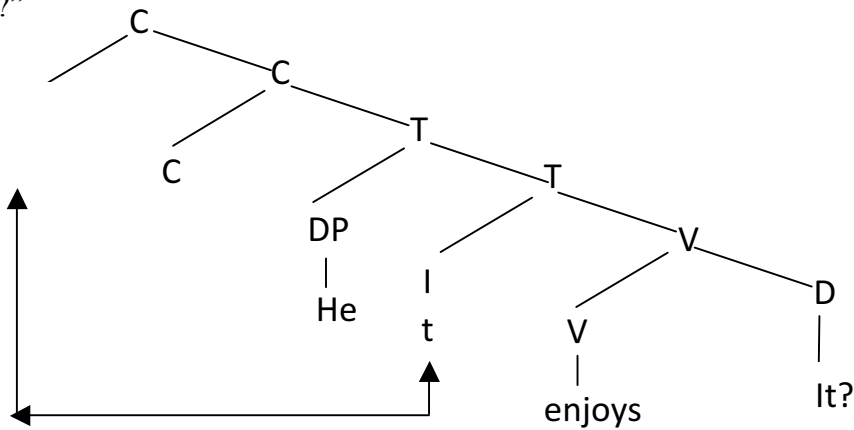

b.

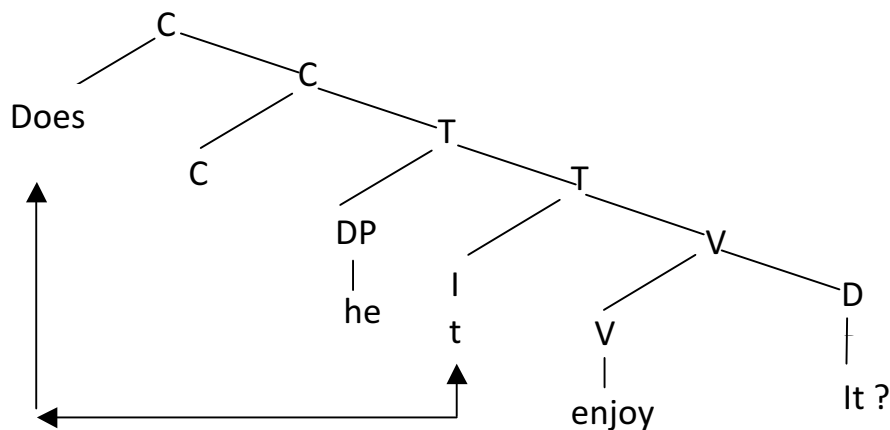

Apart from the grammaticality of this construct, it will be observed that due to the tense form of ‘does’, the main verb in the initial expression ‘enjoys’ automatically acquires the tense/agreement properties which leads to the shading of the ‘s’ inflection. But what happens to Ogbah constructions which bear the same or similar constraint as the one discussed above. Let us use the sentences below to resolve this entanglement:

19. Uche Kponi Onyema ndaglah.

Uche told Onyema lie

“Uche lied to onyema”

The sentence has no auxiliary but the tensed verb ‘Kponi’ (‘told’). For direct question to be achieved from this expression it will not be done by raising V-to-C since the latter is weak in Ogbah. Adopting the same approach as in that of English, the enclitic ‘som’ will emerge from I and prepose on the predicate noun, ‘ndagla; (lie). When once this movement is completed, the construct phono-syntactically changes to have the bearing of question in Ogbah. The emanation of the enclitic ‘som’ from INFL is justified based on the fact that “clitics...are members of a

lexical category such as verb, noun or pronoun or preposition” (O’Grady et al p140). ‘Som’ is a verb subcategory.

20. C + DP (Uche) + I +DP +V (Kponi) +DP Onyema ndagla

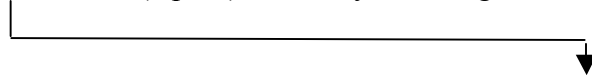

C + DP (Uche) + t₁ + DP + V (Kponi) + DP Onyema ndagla(som?)

Summarily, in English, I-Movement raises to C, while it lowers to DP in Ogbah.

Another distinction of this parameter for Ogbah is that the INFL enclitic “som” can even apply to Ogbah grammatical structures having aux + finite verbs. It works this way. Instead of lowering, for example, the enclitic ‘wnala’ to ‘mhe’ in INFL, the inflective enclitic projects from I, lowers and attaches left of (DP) ‘Uloh’. Consider the tree diagram below in respect of the above proposition.

This paper argued that in Ogbah language, V-movement to INFL is barred. This time not because of “barriers”, but probably, in Ogbah INFL is weak. The auxiliary position in Ogbah is postpositional to main verbs, and the nature of affixation or inflection is linear; not morphologically based. One may wonder whether the NP to be moved to the matrix of the clause may need to acquire case. To answer this we need to argue that the initial structure and its passivised version produced the same value of meaning despite the transformation. Let us consider the English language example below:

21a. I ate the beans.

b. The beans was eaten by me.

We want to agree with Ndimele (1993) that this results from the effects of the “Chain Transmission Principle” (CTP), which entails the transmission of all the “grammatical properties between an antecedent and its trace”; implying that the moved structure does not leave its meaning properties at the extraction site. The moved NP does not leave behind its earlier assigned thematic role in the original structure. This makes it impossible for the moved grammatical entity to acquire new theta role at the landing site. This case is obvious in English, despite the structural and morphological transformations. But what happens when this NP transformation takes place in the Ogbah language. Let us consider these examples:

22a.

Active: E ri la m egwa ya
Procl eat infl(pst) I beans the

“I have eaten the beans”.

b.

Passive: *Egwa ya e ri la m.
Beans the procl. eat infl(pst) I.

*The beans has eaten me.

The structure produced by the passivisation of the original structure in Ogbah is both defective in syntax and semantics. It means that the CTP strictly cannot apply in the case of the Ogbah language. The impossibility of application results mainly from the post-nominal position of the definite article and the poverty of pronoun in the Ogbah language. In the latter, the pronoun “nmu” (me) clipped to “m” stands for both the subjective and objective imputations. It is inflexible and hardly able to adjust to any other position apart from where its transitivity can affect an NP. Besides, it occurs mainly with the 1st person proclitic.

The inability of the moved NP to be contained at the matrix and the disruption of meaning, violates some constraints. One of the constraints imposed on the T-Movement is that it

must move towards the front of the given structure, and the intended landing site must remain unoccupied prior to the movement. The end result of a movement must produce the same or similar meaning; which means that the original meaning of the control structure have to be preserved (Schneider, 1998 & Ndimele 1993). Because of the insituness of NP² in Ogbah, Move-a failed to move it to the front of the sentence. An attempt to force movement on the NP² will disable its ability to preserve meaning. It means that the Ogbah language has zero tolerance for inter-clausal movement, especially, in the like of passivisation.

X-bar Syntax

Aarts (2001:108) agreed that the non-satisfactory nature of the ‘flat structure’ representation was due to its failure to account for hierarchal structure of the phrase and the intra-relation between and among the structural nodes in the tree. It is in the interest of remedying this deficiency that Chomsky in his Remarks on Nominalisation (1968) proposed an intermediate level in the Phrase Structure Grammar. This renewed phrase structure proposition was made popular by Jackendoff (1970). It will account for the projection which is more minimal than the maximal project (noted as XP) and more maximal than the minimum projection (accounted for as X). This is represented in the following schema:

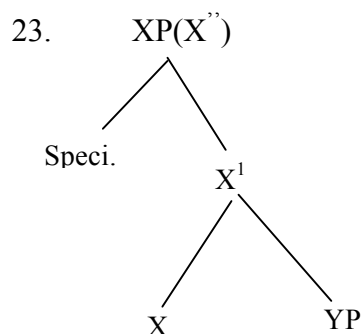

One flaw of the PSG is that it could contain phrases that are grammatical, but redundant in semantic valuability. This is demonstrated by Chomsky’s carnal sentence. It may also create an un-encompassing rule incapable of containing most of the parameteric features of all possible languages, in regard of the phrase structure.

The revised PSG rule would exhibit the following values.

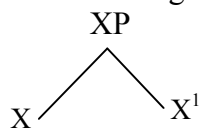

Where: XP – The phrase and its structural components.

X¹ - Intermediate categories (ZP, XD etc)

X – Bare forms categories (N, P, V, ADJ etc)

The intermediate feature (X¹) is the major entry in the Phrase Structure Grammar. Basic structural entries to be noted are head, specifier, complement and adjunct. The head’s relational position to the specifier or complement depends on the language and need. In English, specifier is usually assigned left-most of the matrix as sister of X¹ and daughter of the maximal projection XP. Complement is right-most (in non-stylistic constructions) and attached closely to the head.

In Ogbah, the head precedes specifier; meaning that it is right-most as shown in the schema below:

24.

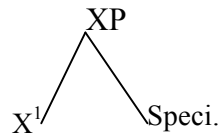

The specifier and adjunct are both attachments of the head; maintaining different grammatical functions. Telaarman (2005:98) noted that the two values are “dependents” of the head; the adjunct being optional and the complement obligatory. This obligatoriness relates to the closer bond between it and the head. Where the two are attached to the head, the adjunct cannot survive deletion, but not the complement; since its deletion from the structure can eliminate or distort the core semantic intendment of the phrase. Napoli (1988:229) agreed that specifiers and adjuncts are optional since not all phrases may accept them, due to the “complex conditions governing when they can and cannot be omitted”.

Conclusion

This paper has attempted an overview and interactional evaluation of the Phrase Structure Grammar (PSG), Transformational Movements (T-Movement) and the X-bar syntax. It showed the need for the accommodation of the cognitive revelations of the principles and parameters notions of modern grammar into language pedagogy of schools. The paper also considered the syntactic-parametric implications of the T-Movement transformation, PSG and X-Bar grammatical theories on the Ogbah and English language. Certain transformational movements are not possible in Ogbah. The X-bar Syntax and Phrase Structure Grammar exact some functional and grammatical parameters. The linguist is left with the thinking that the parameter notion of modern grammar exposes the inadequacies of pre 20th century grammar which was decree natured and socio-politically motivated; rather than cognitive. The paper has showed that the inculcation of the cognitive approach to language pedagogy can enable the involvement of all parties in the teaching and learning processes of language teaching; having had knowledge of the templates for both grammar.

References

- Aitchison, J. (2003). *Linguistics. (6th edition)*. Chicago: McGraw-Hill.
- Anderson, J. M. (1973). *Structural Aspects of Language Change*. London: Longman Group Limited.
- Aarts, B. (2001). *English Syntax and Argumentation (2nd edition)*. New York: Palgrave Limited.
- Carnie, A. (2007). *Syntax: A Generative Introduction (2nd edition)*. UK: Blackwell Publishing.
- Garner, B. A. (1995). *A Dictionary of Modern Legal Usage. (2nd ed.)* Oxford: Oxford University Press.
- Matthew, P. H. (1993). *Grammatical Theory in the United States from Bloomfield to Chomsky*. Cambridge: Cambridge University.
- Mbah, B. M. (1999). *Igbo Phrase Structure*. Prize Publisher: Lagos.
- Napoli, D. J. (1996). *Linguistics: An Introduction*. New York: Oxford University Press.
- Ndemele, O. (1992). *Morphology and Syntax*. Port Harcourt: M & J Grand Orbit Communication Limited.
- Ndemele, O. (1999). *The Parameters of Universal grammar: Government and Binding Approach*. Owerri: African Educational Services.
- Onyedibia, H. O. (2004). *A Complete Guide to English Language (For Schools Colleges and Polytechnics)*. Port Harcourt: Pearl Publishers.
- Palmer, F. (1971). *Grammar*. England: Penguin Books limited.
- Radford, A. (1988). *Transformational Grammar - A First Course*. Cambridge: Cambridge University Press.
- Radford, A. (2004). *English Syntax: An Introduction*. Cambridge: Cambridge University Press.
- Searle, J. R. (1971). *The Philosophy of Language*. Oxford: Oxford University Press.
- Tallerman, M. (2005). *Understanding Syntax (2nd edition)*. London: Hodder Education.
- The Encyclopaedia Britannica (1986) Vol. 23. Encyclopaedia Britannica Inc.
- Traugott, E. C. & Pratt, M. L. (1980). *Linguistics for Students of Literature*. New York: Harcourt Bruce Jovanovich Inc.

Influence of Classroom Interaction Patterns on Student Achievement in Basic Electricity at Technical Colleges in Federal Capital Territory, Abuja

Owodunni A. Samuel

Federal University of Technology Minna
Department of Industrial and Technology Education
Niger state, Nigeria

Abstract

The purpose of this study was to investigate the influence of classroom interaction patterns on achievements of Basic Electricity students in Technical Colleges in Federal Capital Territory, Abuja. A research question and one null hypothesis tested at 0.05 level of significance guided the study. The design of the study was a causal comparative or (expost-facto). The population of the study was 123 Basic Electricity students in Government Technical Colleges in Federal Capital Territory. The students were categorized into two groups based on previous Basic Electricity classroom interaction Categorization test (PCICT)). They were required to make responses based on their personal experience during Pervious Basic Electricity classroom Activities (PCICT). The instrument used for data collection was Basic Electricity Achievement test (BEAT). The instrument was face and content validated by three Basic Electricity Educators and two experts in Measurement and Evaluation. The reliability coefficient of BEAT was established using Kuder- Richardson formula 20 (K-R20) and this yielded an internal consistency of 0.76. Mean and standard deviation were used to answer the research question while one- way Analysis of Variance (ANOVA) was used to test the null hypothesis. Results of the study revealed that classroom interaction patterns significantly influenced students' achievements in Basic Electricity. Recommendations made among others were that classroom interaction patterns be adopted for effective teaching of Basic Electricity in Technical Colleges.

Keywords: Classroom interaction patterns, Achievement, Teaching methods and basic electricity

Introduction

Basic Electricity is one of the science and technology subjects offered in Technical Colleges in Nigeria. Studies have shown that under achievement in science and technology subjects such as Basic Electricity is linked to inappropriate methods of teaching in Technical Colleges (Aina 2000, Oranu, 2003, Federal Ministry of Education, 2000 and Nwagbo & Ohielwe, 2009). For instance, classroom observations in many Nigerian schools and colleges during teachers' supervision showed that majority of the teachers' do not apply appropriate strategies as identified and recommended to be effective for science and technology instruction (Norom, 2009). Basic Electricity classroom activities are still dominated by teacher-centred instruction, which have been found to be ineffective in promoting Basic Electricity learning at technical college (Uzoechi, 2008). These observations are true, irrespective of the subject concerned or the experience of the teacher involved or the nature of the topic being handled (Busari, 2007). Teacher-dominated discourse is not an effective way to promote high-order thinking skills among students. This is because students are inhibited from sharing ideas with the teacher instead they are expected to comply with commands or orders without questioning. The method is related to the lecture method of teaching which affords little or no interaction between the teacher and the students during classroom activities (Viiri and Saari, 2006)

The ineffective teaching methods used in Basic Electricity delivery have been the most important factor in underachievement (Federal ministry of education, 2000). Some of these factors include incompetent mode of lesson delivery by teachers, inadequate use of instructional materials, students' attitude, and ill-equipped laboratories (Umeh, 2008). All these lead to weak classroom discourse based on rote memorization and no provision for adequate development of intellectual and thinking skills among students. Basic Electricity lessons are therefore characterized by a rigid teacher-centred pattern where students' active participation is not allowed, with the absence of opportunity for students to participate in class activities and classroom interaction quickly deteriorated into meaningless waste of time. The Basic Electricity practical and project work which were supposed to equip the students with the necessary practical skills and competencies for functional living in the society are relegated to the background (Ereh, 2005). The learning of Basic Electricity now involves listening, copying and cramming of notes, transfer of learning is at low "ebb leading to low achievement in Basic Electricity". There is a need therefore, to investigate the problem of poor classroom interaction patterns, since achievement in Basic Electricity is still not impressive.

In teaching-learning process, classroom interaction pattern is the way a teacher discusses, converses, talks and expresses verbally and non-verbally to students during learning activities. It is the verbal communication pattern or style of the teacher and the students in a classroom activity. Krat and Kratcoski (2004) opined that classroom interaction is a two-way action between the teacher and the students which may affect learning depending on the clarity of the message. An interaction that occurs in a classroom forms a communication context for learning. These assertions indicate that classroom interaction patterns are essential in teaching and learning situation and would be classified to identify the various types.

Copper and Robinson (2000) pointed out that classroom interaction are in four-dimensional pattern involving interaction between teacher- student, student-student, teacher-material and student-material. The following are the characteristics of each of the patterns as revealed by literature. Teacher- student interaction pattern consist of where the teacher initiates, guides and directs classroom talk with students (Viiri and Saari, 2006).

The uniqueness of teacher-student interaction pattern is not the same as that of the student-student interaction pattern. Student-student interaction pattern enables students talk with their peers (Classmate) in a group to solve a common problem (Viiri and Saari, 2006). This discourse pattern involves the participation of every member of the group. The teacher, after teaching, divides the students into 6 students per group, each group with a peer leader, who is trained by the teacher to lead the group. The students discuss assignments given to them by their teacher in groups, while the teacher coordinates them. Low level ability students are helped by their colleagues who know better and can cope with the discussion as they learn cooperatively. The student-student interaction pattern is used to implement the cooperative/collaborative learning strategy because they are similar characteristics (Muodomu, 2005). Student-material interaction pattern enables an individual or a class to work with instructional materials. Other examples of student-material interaction pattern include: reviewing and expanding lecture notes, reporting practical work, carrying out experiments, searching the internet and reading materials on a website (Smith, 2000). It involves students' active participation and acquisition of manipulative skills (Okoli, 2006). In the teacher-material interaction pattern the teacher illustrates teaching with instructional materials in the classroom (Jaja, 2002). Obodo (2004) found out that instructional resources are potent tools, which can be used to effectively communicate, while enriching the learning experiences of the learners. Also, Obioha (2005), found out that classroom interaction patterns can rotate from teacher to learner, learner to teacher, learner to learner, individually or in groups, verbal expression to chalkboard demonstration, sensory to tactical, visual to audio-visual and listening to performance.

In context of this study, classroom interaction patterns in teaching and learning process is a communication style used to pass information to the learner or simply teacher-student talk pattern in the classroom. The aim is to ensure that learning takes place through the pattern that prevails (Okafor, 2000). The extent of learning taking place in a classroom depends to a great extent, on the magnitude and mode of the teacher's interaction with the learner, the learning materials and the environment. This implies that teachers should provide an interactive teacher-student setting to increase students' cognitive development.

Innovations teaching methods and techniques that have been used in teaching Basic Electricity seem not to have positively influenced the achievement of students in Basic Electricity, since achievement still remains poor (Saka-Alikinla, 2015). The situation raises some doubts as to whether there are other variables such as classroom interaction patterns that can inhibit achievement in Basic Electricity. Therefore, this study is aimed at investigating the influence of classroom interaction patterns on students' achievement in Basic Electricity in technical Colleges in Federal Capital Territory, Abuja.

Statement of the Problem

Basic Electricity is a popular science and technology subject offered by both science and technology students in technical college. Literature has however revealed that students' underachievement in science and technology subjects such as Basic Electricity is linked to inappropriate methods of teaching in technical college. The persistent poor performance coupled with poor classroom practices has resulted in few students choosing Basic Electricity related courses as career. This has therefore created an educational gap of students not continuing their studies in Basic Electricity related courses at tertiary institutions. This gap can be filled by devising a more effective strategy for improving the situation in order to meet the needs of the students and the society at large. It is therefore certain that without using an effective remedial strategy, Basic Electricity teaching and learning may continue to be poor in our schools.

In view of this situation, effective classroom interaction patterns may be useful in teaching Basic Electricity in order to improve the persistent poor performance in Basic Electricity. The problem of this study posed as a question therefore is: What influence do classroom interaction patterns have on achievement in Basic Electricity in technical Colleges?

Purpose of the Study

The purpose of the study was to investigate the influence of classroom interaction patterns on students' achievement in Basic Electricity

Research Question

What is the influence of classroom interaction patterns on the mean achievement scores of students in Basic Electricity?

Hypothesis

HO: Classroom interaction patterns have no significant influence on the mean achievement scores of students in Basic Electricity.

Methodology

The study was a causal comparative or (expost4acto) design, where the independent variables among subjects cannot be manipulated or controlled. The subjects are studied in their settings without any behaviour modifications introduced by the researcher.

The population of the study consisted of all 123 Technical Two (TC II) Basic Electricity students in Government Science and Technical College (GSTC) Garki and Federal science and Technical College (FSTC) Orozo all in FCT. The entire population was used for the study. GSTC Garki had one intact class of 48 that offered Basic Electricity and FSTC Orozo had two intact classes of 73 that offered Basic Electricity. The students were categorized with Previous Basic Electricity Classroom Interaction Categorization Test (PCICT) which also classifies learners into (a) Teacher Active, Students Mainly Receptive, (b) Teacher Active, Students Equally Active and Students Active, Teacher Partly Receptive. These two categorization tests were administered effectively with the help of the trained research assistant in each technical college.

Basic Electricity Achievement Test (BAT), constructed by the researcher was the only instrument used for data collection in this study. Developed BAT is a multiple-choice objective test. Each item has 4 options, lettered A — D. The test was based on the units of study in TC II Basic Electricity curriculum used for the study. The researcher initially constructed 100 multiple-choice items before face validation. The items measured the six objectives in the cognitive domain of Bloom's taxonomy of educational objectives. A table of specification was used in constructing the BAT objectives items. The weighting for the objective levels were based on the proportion of the low and high order performance objectives in the unit of study. The instrument was validated experts in Basic Electricity. BAT reliability coefficient was determined with Kuder-Richardson 20 (K — R20) methods and was found to be 0.76.

The researcher briefly trained three research assistants each with B.Sc. (Ed) qualifications for two hours each day for three days on the concepts of classroom interaction patterns and its relevance in teaching/learning process were explained to the participants. The researcher taught them that classroom interaction using PCTCT categorizes was designed specifically to classify learners into different categories of learning. The relevance was to assist in meeting the learners' needs during teaching/learning process. The Researcher Assistants were taught how to identify classroom interaction patterns in teaching/learning

situation and previous classroom interaction patterns in a teaching/learning situation. The participants were required to share their experiences as regards to poor results in Basic Electricity.

The categorization test used in this study was Previous Classroom Interaction Categorization Test (PCICT). The PCICT has a scale range and was designed to assess interaction processes of the learners in the previous Basic Electricity classroom activities and was also used to classify learners into three categories. The three categories are: (a) Teacher Active, Students mainly Receptive ranging from 1 to 1.49; (b) Teacher Active, Student Equally Active ranging from 1.50 to 2.49; and (c) Student Active, Teacher Partly Receptive ranging from 2.49 to 3.00. They were required to make responses based on their personal experience during previous Basic Electricity classroom activities. PCICT is preferred for use in this study because it provides a range to identify different types of interaction processes in previous Basic Electricity classroom activities. This was administered in the two technical colleges to students with the help of the trained research assistants. This provides a range to identify different types of interaction processes in previous Basic Electricity classroom activities. At the end, BAT instrument was administered on each of the students in the colleges. The scripts from students were marked and recorded using the marking guide. The scores collected were used for data analysis.

Data were analyzed using descriptive and inferential statistical methods. The research question was answered with mean and standard deviation while Analysis of Variance (ANOVA) was used to test the null hypothesis at 0.05 level of significance. To determine the direction of the difference for significant means, post-hoc multiple comparison test were conducted, using the scheffe method. This method was deemed appropriate because it is applicable to groups of unequal sizes.

Results

The result of this study is presented in accordance with the research questions and hypotheses that guided the study.

Research Question

What is the influence of classroom interaction patterns on the mean achievement scores of students in Basic Electricity?

Groups	Previous classroom interaction category	N	Mean	Standard deviation
PCIC 1	Teacher Active, Students Mainly Receptive	32	28.33	5.25
PCIC 2	Teacher Active, Students Equally Active	40	26.35	6.28
PCIC 3	Students Active, Teacher’s partly Receptive	51	23.65	5.15
Average Mean and Standard Deviation			26.11	5.56

Table 1: Mean Achievement scores and Standard Deviation of Students in Basic Electricity in Previous Classroom Interaction Categorization test (PCIC)

Data on table one shows that students of group 1 in Teacher Active, Students Mainly Receptive in Previous Classroom interaction category test had a mean achievement score of 28.33 and standard deviation Of 5.25. Students of group 2 in Teacher Active, Students Equally Active in Previous classroom interaction category test had a mean achievement score of 26.35 and standard deviation of 6.28. While students of group 3 in Students Active, Teacher’s Partly Receptive in Previous classroom interaction category test had a mean achievement score of 23.65 and standard deviation of 5.15. PCIC 1, 2, 3 are the rating scales of Previous Basic Electricity Classroom Interaction Categorization Test which was developed and adapted by the researcher.

Hypothesis

HO: Classroom interaction patterns have no significant influence on the mean achievement scores of students in Basic Electricity.

To test this hypothesis a one-way Analysis of Variance was done.

Source	Df	Sum of squares	Mean Squares	F	Sig	Decision
Between Groups	2	871.7333	399.8220	9.2883	.0000	S
Within Groups	120	11324.6273	43.3043			
Total	122	12196.3606				

Table 2: One-way Analysis of Variance (ANOVA) of students' means Achievement scores in Basic Electricity in Previous Classroom Interaction Categorization Test (PCIC)

The data on table 2 shows that students' mean achievement scores in Basic Electricity in the previous classroom interaction category differ significantly in achievements. This is indicated by the calculated F-value of 9.2883, which is significant at .0000, which is less than 0.05 level of probability. Therefore, the null hypothesis of no significant influence of classroom interaction patterns on the mean achievement scores of students' in Basic Electricity is rejected. This suggest that there is a significant influence of classroom interaction patterns on the mean achievement scores of students in Basic Electricity in the previous classroom interaction category test, which consists of three categories namely; Teacher Active, Students Mainly Receptive (group 1), Teacher Active, Students Equally Active (group 2) and Students Active, Teacher Partly Receptive (group 3) respectively. To find out the direction of difference, a Scheffe post hoc multiple comparison tests between two means, at 0.05 level of significance were carried out and presented in table 3.

Table 3: Scheffe Post-hoc Multiple Comparison Test between two mean scores in Previous Classroom Interaction Category.

The difference between two means is significant if
 $\text{Mean (J)} - \text{Mean (I)} \geq 3.7562 * \text{RANGE} *$
 $\text{SQRT} (1/N (I) + 1/N (J))$ with the following value(s) for Range 2.85
 *indicates significance differences which are shown in the table below

Mean	PCIC
23.65	Grp 3
26.35	Grp 2*
28.33	Grp 1*

(*) indicates group significant difference at 0.05 level of significance.

The results as shown in table 3 revealed that each group in previous classroom interaction category differed significantly from each other. The result showed that students in group 3 had a mean score of 23.65 which differed significantly from group 2 and group 1 respectively. The students in group 2 had a mean score of 26.35 which differed significantly from group 1 and group 3 respectively. While the students in group 1 had a mean score of 28.33 which differed significantly from group 2 and group 3.

This implies that students in group 1 performed better than group 2 and group 3 respectively. While the group 2 students performed better than group 3 students in Basic Electricity achievement test. Therefore, classroom interaction pattern had a significant influence on the mean achievement scores of students in Basic Electricity.

Discussion

The results of the data analysis presented on table one revealed that the mean score of students in Teacher Active, Students Mainly Receptive group 1 in Previous Interaction Classroom was 28.33, while the mean score of students in Teacher Active, Students Equally Active group 2, was 26.35. The same table also indicated the mean score of students in Students Active, Teacher's Partly Receptive group 3 as 23.65. A test of hypothesis of no significant influence of classroom interaction patterns on the mean achievement scores of students in Basic Electricity was rejected (calculated F-value 9.2883 which is significant at .0000, but is not significant at 0.05 level of probability). This implies that there is a significant influence of classroom interaction patterns on students' mean achievement scores in Basic Electricity.

The relative effectiveness of classroom interaction patterns in enhancing students' achievements could be due to the unique characteristics in the teacher-student interaction pattern. The teacher guides and directs the classroom talk towards a specific target (Viiri and Sari, 2006). The teacher in playing this guidance role moderates students' effort such that where there is a mistake or a digression, the teacher puts the students' right, so that students can make meaningful contributions. This result is also in line with the findings of Hogan, Nastasi and Pressley (1999), that, teacher-guided discussions are more efficient means of attaining high levels of reasoning and higher quality of explanations.

The teacher-student interaction pattern on the other hand is participatory and democratic in that the teacher allows the students to participate actively in the lesson; while at the same time the teacher gives the students' praises and encouragement when they make correct attempts. In addition, the teacher entertains questions and free interaction exists between the teacher and the students (Viiri and Saari, 2006); which encourages students to contribute freely on what they know or discovered during the learning process. Teacher-student participatory affairs, during lesson can be synonymous to a learner-centred approach in teaching. It is no doubt an essential ingredient in students' optimal academic achievement and good classroom climate (Onimisi, 2006). The promotion of good classroom interaction therefore lies with the teacher that provides the enabling social and psychosocial atmosphere through democratic leadership style during lessons and personal qualities that must be endearing (Onimisi, 2006).

The student-student interaction pattern or discussion pattern promotes co-operative learning; the participants strive for mutual benefits among group members (Agarka, 2002). The students' under this learning encounters work collaboratively in order to seek solution to a common problem by supporting each other. The low ability level students in the group are helped to improve through interactions with the other colleagues that are brighter. This could account for the observed improved achievement of students' in Basic Electricity.

The student-student learning discussion incorporates the elements of listening, talking, questioning, responding, reflecting, exchanging viewpoints, debating, writing answers and comments to questions and reading assignments for class discussion. Hence, students learn through social interaction which is a powerful learning tool in the educational system (Smith, 2000). This result is in line with Lee's (2000) finding, that only 11 out of 42 learners spoke during questions and answers discussion in the teacher fronted discussion, while 46 out of 46 learners spoke during the group discussion among students which showed participation of every students in a lesson. The finding of the study is also in line with that of Hogan, Nastasi and Pressley (1999) that peer discussion tended to be more generative and exploratory. The finding implied that students found out facts which helped them to contribute meaningfully to achieve better results.

The finding that students' mean achievements scores in Basic Electricity were significantly influenced by classroom interaction patterns is in agreement with the findings of Okoli (2006) and Anekwe (2006), that two interaction learning styles, co-operative and

competitive significantly enhanced students' achievement in Basic Electricity and chemistry, than conventional learning styles. The result also agreed with Kalu (2004) that classroom interaction patterns correlated significantly with students' academic achievement in physics.

However, the finding does not support the study of Okafor (2000) that finds no significant influence of classroom interaction patterns on students' mean achievement scores in Basic Electricity. Thus, Shomossi (2004) and Edet (2006) studies were in conformity with the findings that classroom - correlated significantly with students' academic achievement in physics. Udeani (1992) and Onimisi (2006) studies were in agreement with the findings that more democratic participatory interactions offer higher premium to integrated science students. In the same manner, the result is in agreement with Okebukola (2004), that cooperative learning experience facilitated achievement of students' learning in Basic Electricity and chemistry respectively. As a result of this relationship the findings of these studies were used to support the findings of this study. Therefore, the finding that classroom interaction patterns significantly influenced students' academic achievement in Basic Electricity is not misleading.

Conclusion

From the results of this study, it is clear that persistent poor students' achievement in Basic Electricity could be attributed to teachers' inability to look at classroom interaction patterns in the context of teaching. This is because with the use of this variable as main influence in this study, achievement of students improved greatly. It is hoped that mass adoption of classroom interaction patterns in teaching would bring about the much desired improvement on learning outcomes in Basic Electricity. It is a known fact that curriculum change is a gradual process which needs the input of experts in order to improve achievement in a given subject. With this fact in mind, classroom interaction patterns can skillfully and gradually be included in the Nigeria's school curriculum in order to achieve better results in Basic Electricity.

Recommendations

From the result of this study, the following recommendations are made:

1. It is evident that since the adoption of the classroom interaction patterns was found to be effective in improving students' achievement in Basic Electricity, teachers should use classroom interaction to facilitate their Basic Electricity teaching.
2. The curriculum of teacher education in the country should include the use of classroom interaction patterns during teaching to identify learners' problem in Basic Electricity.
3. Training workshops and seminars should be organized and made compulsory for practicing teachers to embrace the skills of classroom interaction patterns for effective implementation in teaching and learning process.

References

- Aina, O. (2000). Nigeria technical and vocational education in the near future. In Federal Ministry of Education (2001), *The National Master-plan for Technical and Vocational Development in Nigeria in the 21st Century with the Blue Print for the Decade 2010*. Abuja, FME.
- Anekwe, M. (2006). The effects of students' interaction patterns on Cognitive achievement retention and interest in Chemistry in Anambra state. *Unpublished Ph.D Thesis, University of Nigeria, Nsukka*.
- Busari, O.O.(2007), "Productive Science and Technology Education for Nigerians. The Interaction of Community and School resources". Being a paper present at UNESCO Workshop Abuja.
- Cooper, J., & Robinson. P. (2000). Getting started: Informal small- Group strategies in large classes': In Macgregor, T.J., Cooper, K.T., Smith & Robinson P. (Ed), *Strategies for Energizing large classes: from Small Groups to learning Communities; New Directions for Teaching and Learning*, 81 spring, 17-24.
- Ereh, C. E. (2005). Teacher characteristics and school Curriculum Implementation in Nigeria Secondary Schools: A theoretical Secondary review. *Journal of the Nigeria Academy Education*, 2(1):111-120.
- Federal Ministry of Education (2000). Technical and vocational education development in Nigeria in the 21st century with the blue-print for the Decade 2001 – 2010. Abuja; Federal Ministry of Education
- Hogan, K. Nastasi, B. K., & Pressley, M. (1999). Discourse patterns and collaborative scientific reasoning in peer and teacher-guided discussion. *Cognition and Instruction*. 11(4):379- 432.
- Jaja, O.P. (2002). Assessment of Biology study support environment in our Schools. 43 Annual Conference Proceedings of Science Teachers' Association of Nigeria.
- Kalu, A. (2004). Classroom Interaction Patterns Teacher and Student Characteristics and Students' Learning outcome in Physics *Journal of Classroom Interaction*, 39(2):24-31.
- Krat, K.B. & Kratoski, A. (2004). Teacher-student interactions in a ubiquitous computing environment learning within dyads & triads of interactions. *Journal of the Research Centre for Educational Technology*. 1:306-410.
- Lee, J.F. (2000). *Task and Communicating in language classrooms*. New York: McGraw-Hill publishers, LTD.
- Nwagbo, R.C. & Ohielcwe, C, (2009). Using Constructivist Model as a Practical Approach to Effective Teaching of Soil types and water holding effects of Soil on Vegetation for Sustainable Development In C.R. Nwagbo, U.M. Nzewi & A.G. Ajewole (Ed) Proceeding of the 2009. National Biology Panel Workshop Series, pp 88-95.
- Obioha, P.O. (2005). Maintaining peace and harmony through classroom *Organization and Management, Journal of Women in college of education*. 9:256-257.
- Okafor, L.C. (2000). Analysis of classroom interaction patterns in Biology In secondary schools in Anambra state. *Unpublished Ph.D, Thesis, University of Nigeria Nsukka*..
- Okebukola, P.A.O. (2004a). Effect of Cooperative and Competitive Interaction Technique in strengthening student's performance in science classes. *Journal of Science Education*. 69(4):501 - 509.

*Influence of Classroom Interaction Patterns on Student Achievement in Basic Electricity
at Technical Colleges in Federal Capital Territory, Abuja*

- Obodo, G. C. (2004). Generating students' interest in mathematics. A paper presented on the NMC/PTDF workshop for secondary school teachers from 8th –14th February at Awka, Anambra State held at Igwebuikwe grammar school.
- Okoli J.N. (2006). Effects of Investigative Laboratory Approach and Expository Method on Acquisition of Science Process Skills by Biology Students of different levels of Scientific Literacy. *Journal of Science Teachers Association of Nigeria*. 41(2):79 - 88.
- Onimisi, J.A. (2006). Impact of type of Teacher Training on students Achievement and attitude towards integrated science in Kogi state. *Unpublished PhD Thesis University of Nigeria, Nsukka*.
- Oranu, R. N. (2003). Vocational and specialized training in Nigeria. Recovered on July 18, 2005 from <http://www.ibe.co.org/educational module/Africapdf/lago2ora.pdf>.
- Saka-Alikinla, I. (2015). Comparative effects of structured and guided inquiry instructional techniques on technical college students achievement in basic electricity. *Unpublished M.Tech Thesis, Federal University of Technology Minna, Niger State*
- Smith, K.L., (2000). 'Going Deeper; Formal Small-Group Learning in large Classes'. In J. MacGregor, J.L. Cooper, K.L. Smith & Robinson classes: From small Groups to learning communities *New Directions for teaching and learning*. 81, spring, 25-46.
- Umeh, M.O. (2008). Reducing Teachers' Instructional Difficulties in some Content areas of senior secondary school Biology Curriculum for Sustainable development Proceedings of the 49th Annual conferences of STAN and Inaugural conference of CASTME Africa. (Akale M.A.G ED), Heinemann Educational Books (Nigeria) Plc 219-223.
- Viiiri, J. & Saari, H. (2006). Teacher talk patterns in science lessons: Use in 1 ea< -her Education. *Journal of Science Teacher Education*. 17:347-365.
- Uzoechi, B.C. (2008). Determinants of students Questioning, Attitudes in Science lesson. *Unpublished PhD Thesis University of Nigeria, Nsukka*.

The Collaborative Classroom: Digital Tools for Academic Writing

Richard Peel and Dawn Murray

Higher Colleges of Technology
Dubai, UAE

Abstract

Collaborative learning has its roots in Vygotsky's early 20th Century theories of the social nature of learning, which diverged from the traditional individualistic approach. A hundred years later, and the introduction of iPads and mobile devices has provided us with new and powerful collaborative learning tools that were scarcely imaginable even a decade ago. Online platforms such as digital walls, applications (apps), and Open Education Resources are providing students with unprecedented collaborative learning possibilities. This paper examines such tools currently implemented on a tertiary level academic English Writing Foundations Programme, showcasing examples of students' work and addressing pedagogical and technological considerations. One of the most potent aspects of online learning is the provision of shared virtual platforms which allow students and teachers to collaborate, brain-storm and learn/coach collectively. It has been found that collaborative digital approaches to academic writing tasks are highly beneficial to students who have previously found this skill challenging when approached on an individual level, especially given the profile of our students who are generally of lower intermediate level, with little or no experience of academic writing—even in Arabic, their first language. Readily available tools to promote real time and asynchronous collaboration on a variety of academic writing essay topics will be examined, including mind-mapping applications such as Popplet and Mindomo, sharing tools such as Padlet walls and Lino stickies, and Open Education Resources like those available on the "readwritethink" website.

Keywords: iPad, Academic writing, EFL/ESL/ELT, Collaborative learning

Introduction

iPads are commonly regarded as individual learning devices in the literature, designed for single users (e.g. Benson 2013, Melhuish and Falloon, 2010), and not suitable for group activities or collaborative learning. In addition, many in the field have criticized the iPad for not being a suitable device for academic writing activities, particularly extensive writing (e.g. Woykes, 2011, Gilksman et al, 2011, Weider, 2011, and Atallah et al, 2015, the latter specifically focusing on academic writing at universities in the UAE).

However, here at the Higher Colleges of Technology, we have found iPads to be useful tools in a number of collaborative writing activities, most notably brainstorming, scaffolding and planning. Particular apps that we have used include Padlet, Lino Stickies, Mindomo and Open Education Resources such as “readwritethink.” These are discussed in more detail later.

Given the academic profile of our students who are largely lower intermediate level and have little experience of academic writing, it has been found that working collaboratively serves to enhance their confidence and expand their skillset in tackling the IELTS Academic Writing Test, which is their exit point from the Foundations course. Though the Academic IELTS Writing Test is a paper-based, individual assessment, nevertheless anecdotal evidence is that students report greater confidence in tackling the paper and gaining the skills necessary through the less stressful learning experience of working with peers.

Our experience is our learners can achieve far more when working collaboratively, as they capitalize on one another’s resources and skills. By contrast, working individually students can often find the difficulty of the academic writing tasks overwhelming, especially at the beginning of the course.

Background

The teaching context is a Foundations Programme at the Higher Colleges of Technology (HCT). All federal universities (Zayed University, UAE University, and HCT) have foundations programmes, which are pre-Bachelor’s courses of up to two years to prepare students for their university majors. With the exception of a few courses such as Arabic and Sharia Law, all courses are taught in English. The gatekeeper for foundations programmes is an Academic IELTS Band 5 – students can then progress to their Bachelor’s course. Most students who enter Foundations correlate to an IELTS band 4.0/CEFR B1, so their level of English is low, and most have little or no experience of academic writing, even in L1. Many also have a low academic level in other subjects and general knowledge (O’Sullivan, 2004), and thus have no schemata to draw on when tackling academic writing questions, and these difficulties are compounded by their limited reading either in L1 or L2 (Peel, 2014: 135).

Academic writing is thus a great challenge for students, and based on our experience the collaborative model helps by reducing the anxiety some students experience during individualistic learning, and instead fosters an atmosphere of non-threatening cooperative engagement.

Literature Review

Much of the theory of Collaborative Learning derived from the work of Soviet psychologist Lev Vygotsky from the early 20th Century. Vygotsky’s theories of the social nature of learning were largely forgotten till the 1980s, when social interdependence theory and collaborative learning became popular (Wertscht, 1985). Vygotsky’s theories stressed the importance of personal relationships, and considered the mood of a learner to be an important

affective factor in the acquisition of knowledge and skills, like Krashen's much later input theory (Krashen, 1977). Vygotsky also maintained that different members of a group may have different perspectives/knowledge to offer, and, as a collaborative partnership, improve learning outcomes. Probably the most important of his theories was the Zone of Proximal Development (ZPD) – where learners can do tasks with guidance or peer support that individually they would be unable to do.

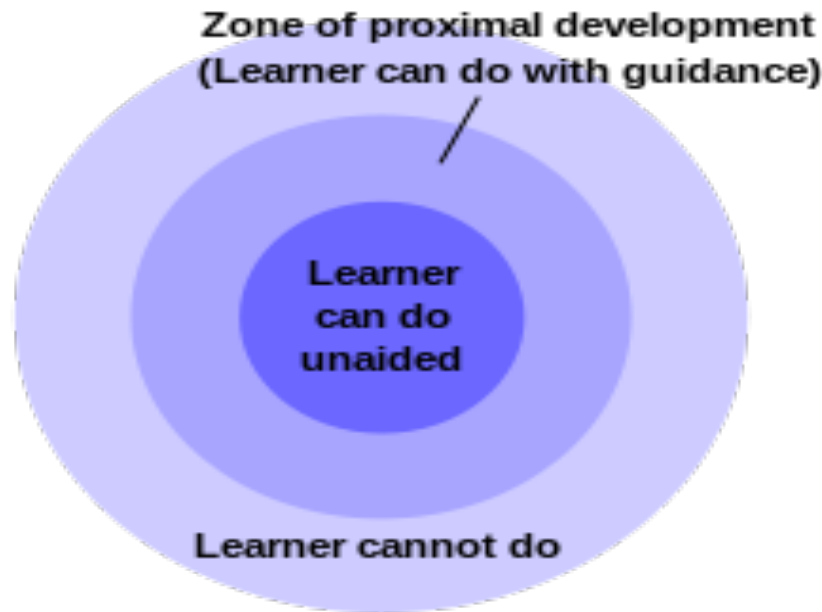

Figure 1. Vygotsky's Zone of Proximal Development

As social interdependence theory and collaborative learning developed in the 1970s/80s, many of the aspects of modern English Language Teaching methodologies emerged largely derivative of this theory, such as the Communicative Approach, and Task Based Learning.

The Collaborative Learning Model stresses that strong interpersonal relationships are important, and that individuals depend on and are accountable to each other. Knowledge is created as members interact, sharing experiences and possibly taking on asymmetrical roles. Many mediums are possible from traditional ways of interacting such as face-to-face group discussions, to digital discussions such as online forums and chat rooms.

Collaborative Learning Research Findings

More than 1200 studies comparing collaborative, competitive, and individualistic efforts have found that collaborative and cooperative learning methods improve students' time on tasks and intrinsic motivation to learn, as well as students' interpersonal relationships and expectations for success (Johnson & Johnson, 2009). Lower and intermediate students appear to benefit the most from this approach, which matches the profile of the students here at public tertiary institutions in the UAE. In collaborative learning, student interpersonal relationships are strengthened, and it has been found there is a strong correlation between the latter and academic achievement (Roseth, Johnson and Johnson, 2008).

Collaborative learning is already widely used in contemporary English Language Teaching via the Communicative Language Teaching (CLT) paradigm which emerged in the

1970s, and since its inception has remained the dominant methodology in ESL/EFL (Richards, 2006: 1). CLT is the approach used in pre-service training courses such as the Certificate of English Language Training to Adults (CELTA Syllabus, University of Cambridge, 2010, p.15), and collaborative learning activities such as group and pair work, brainstorming, mind-mapping are typical of CLT activities. Collaborative learning is also firmly embedded in related teaching approaches such as Task Based/Project Based Learning.

Though collaborative theory is nothing new, our students, as digital natives (Prensky, 2001), and the emerging digital landscape and apps, have given collaborative learning an entirely new perspective. In the 21st Century Academic Forum (November 13 – 15, Dubai, UAE) a number of Apps used for collaborative learning were showcased. These included Padlet for brainstorming, Lino stickies for creating and sharing groups of lexical/grammar functions, and Popplet, Mindomo and Open Education Resources such as “readwritethink” for collaborative planning and mind-mapping of academic essays.

Some of these examples are featured below:



Figure 2. Student collaboration - cause and effect essay example - Padlet

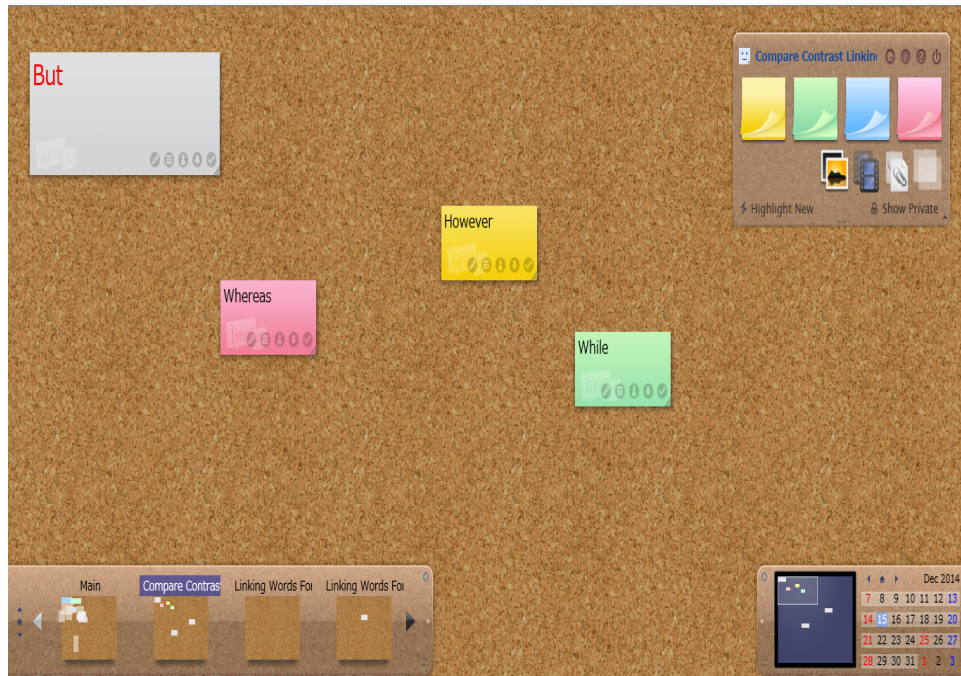

Figure 3. Student collaboration - compare contrast lexis example - Lino stickies

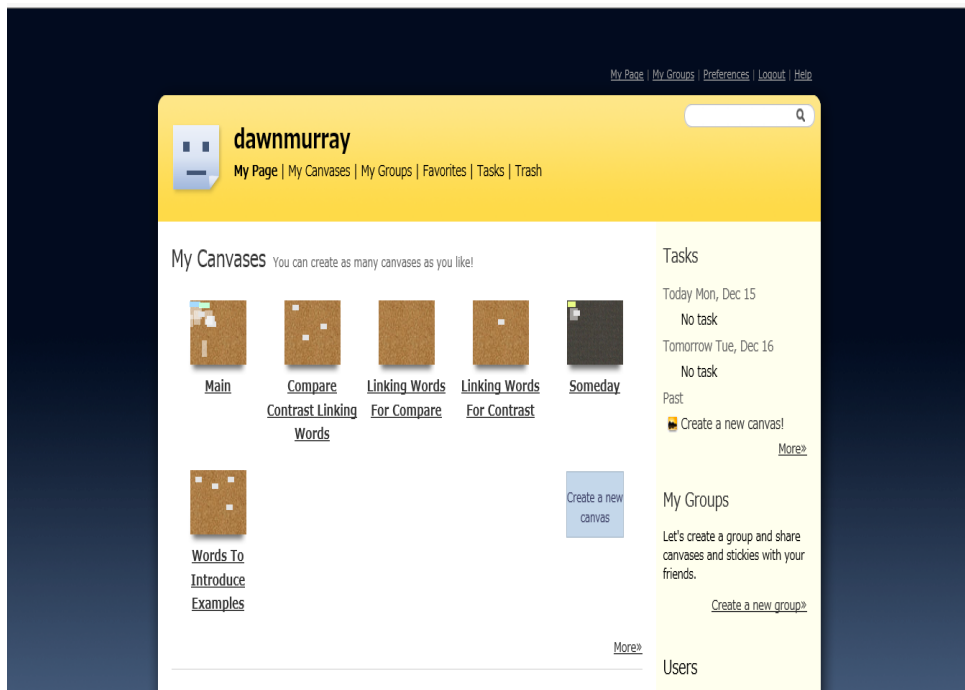

Figure 4. Student collaboration - sharing and creating groups - Lino stickies

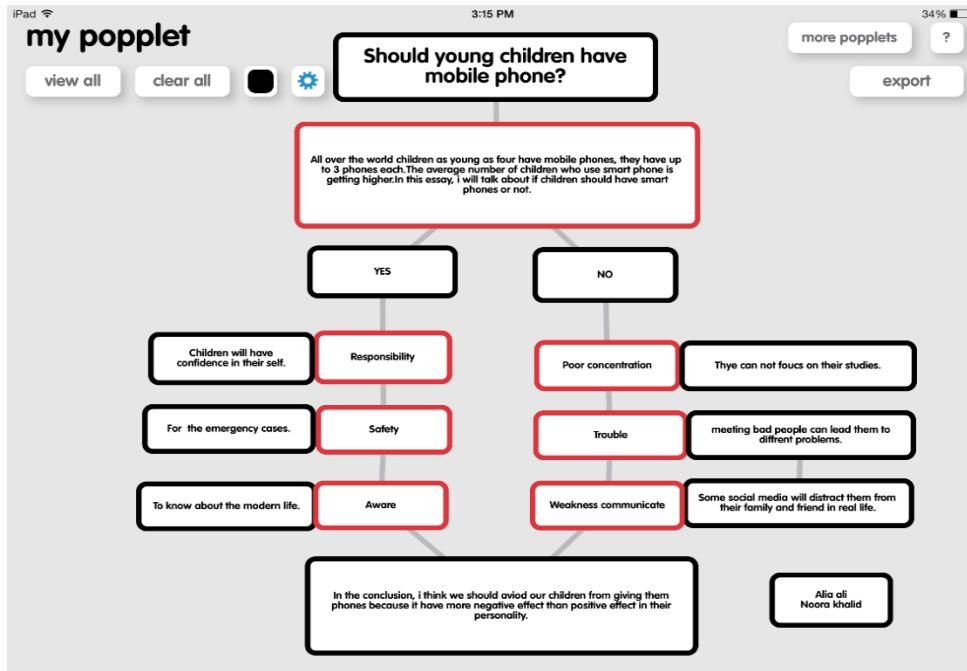

Figure 4. Student collaboration - plan for an opinion essay - Popplet

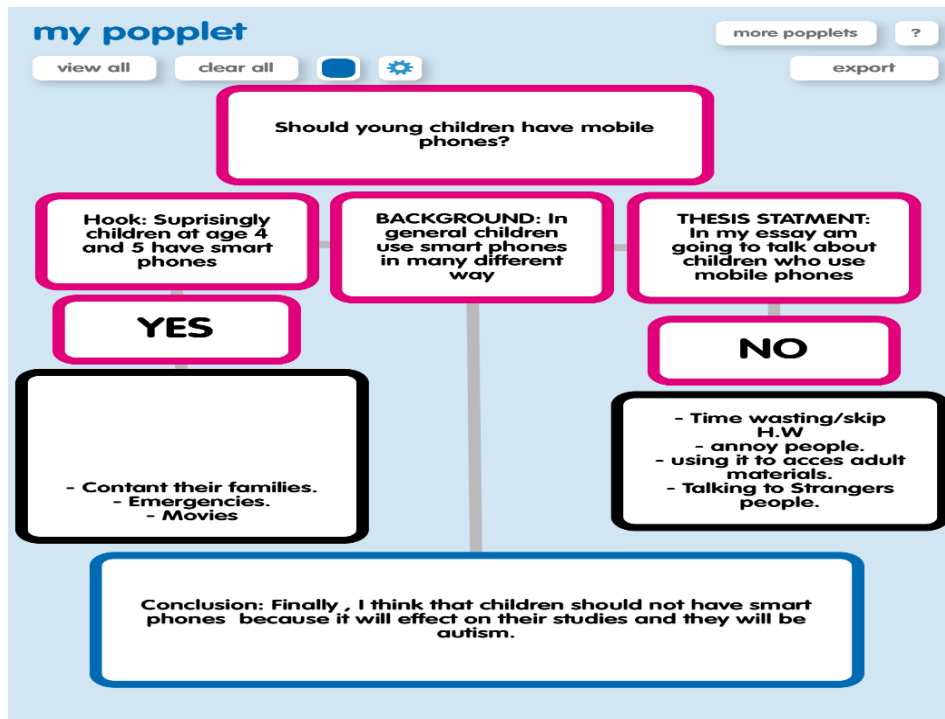

Figure 5. Another plan for an opinion essay – Popplet

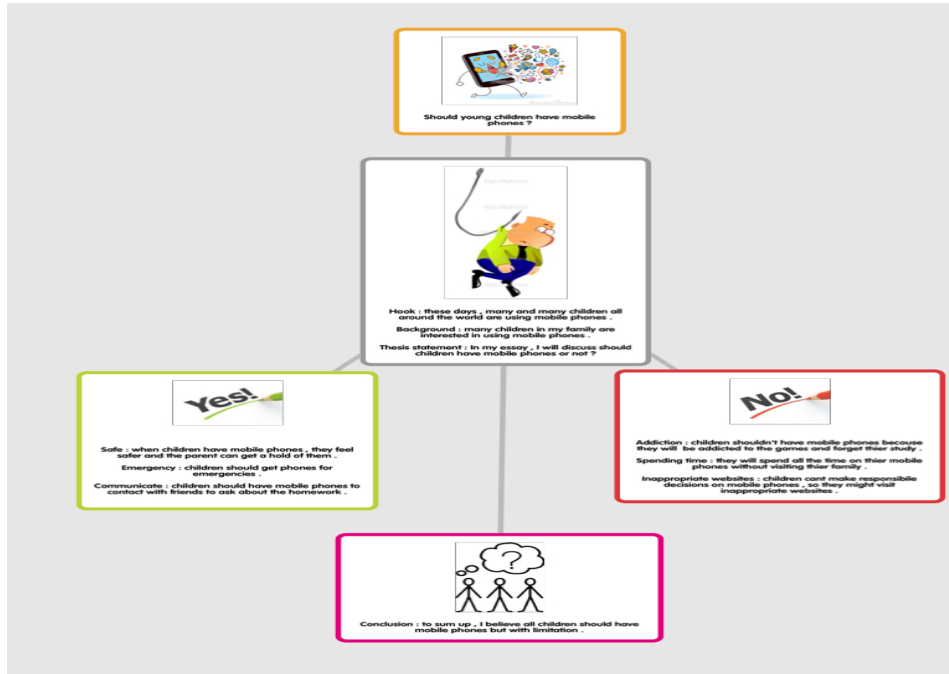

Figure 6. Students' third plan for an opinion essay – Popplet

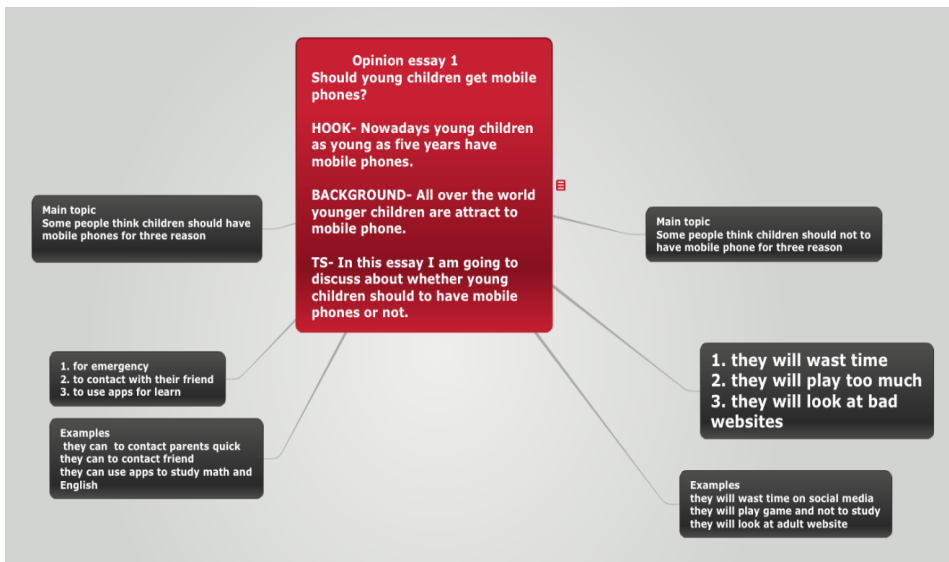

Figure 7. Students' plan for an opinion essay – Mindomo

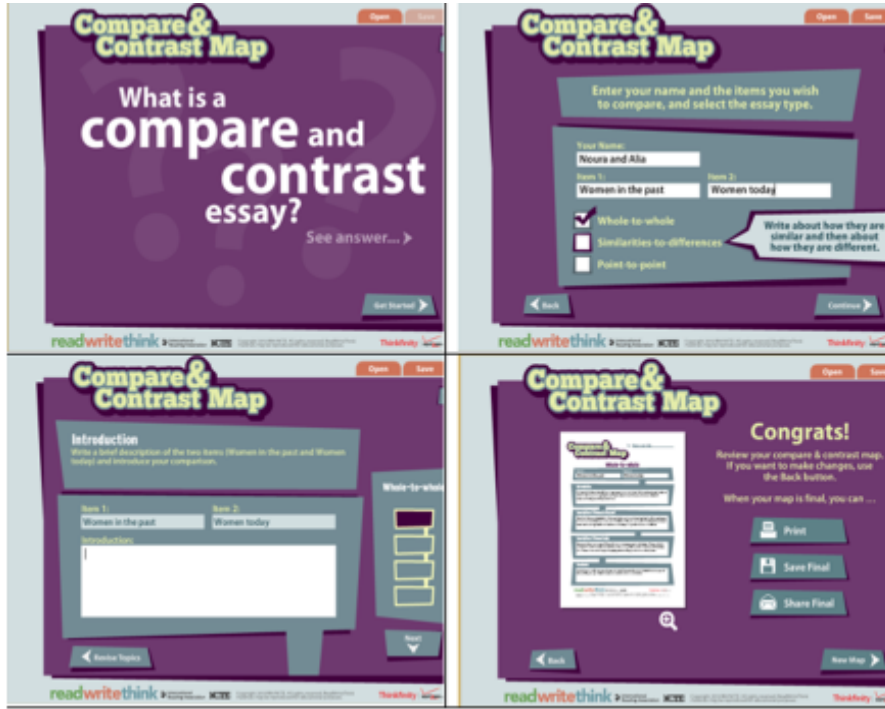

Figure 8. Completing a map - compare contrast – “readwritethink”

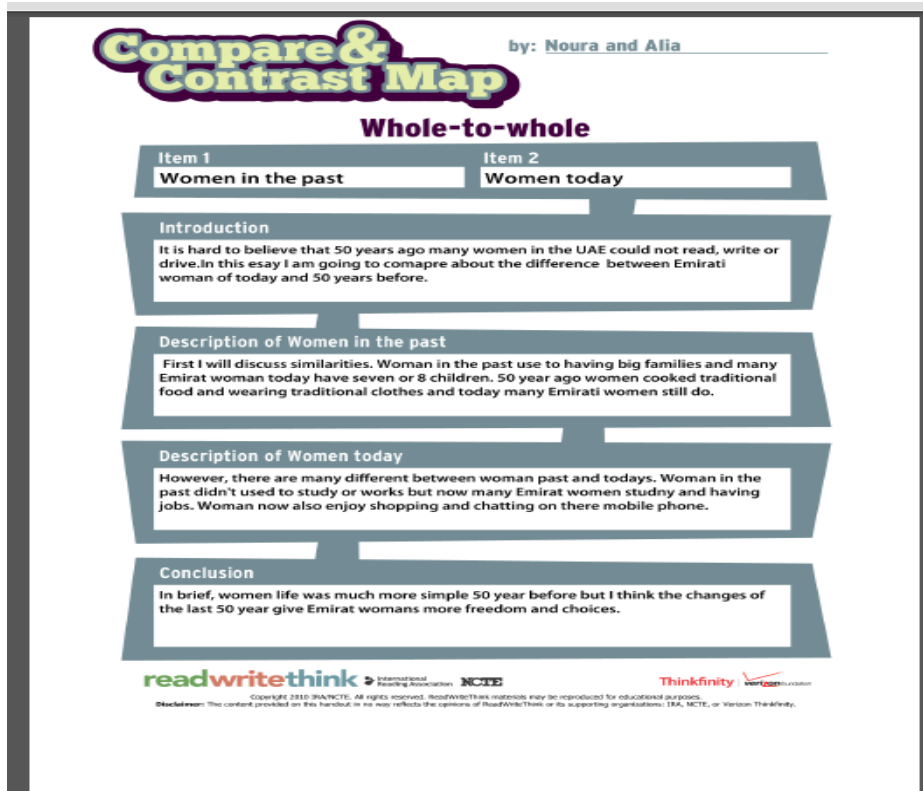

Figure 9. A completed map - compare contrast – “readwritethink”

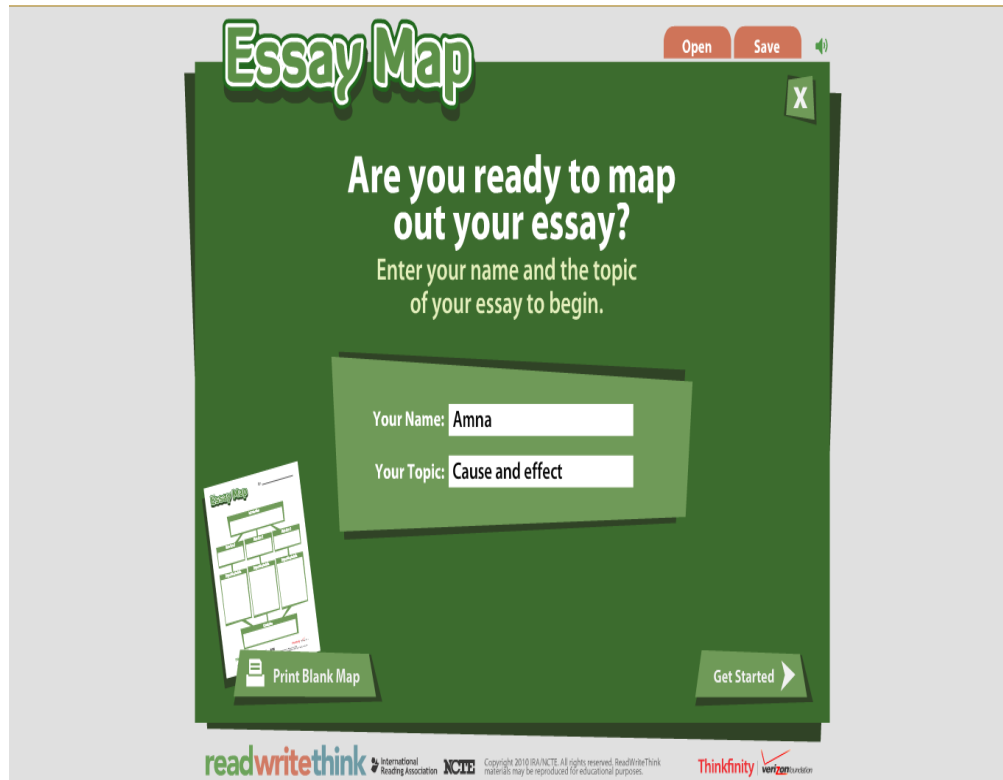

Figure 10. A different type of map from “readwritethink”

Discussion

In conclusion, our institution has found iPads to be highly effective collaborative writing tools for learners at the beginning of their English writing courses, particularly in the early stages of planning and mapping academic essays. Our mainly lower intermediate level students find academic writing extremely challenging, and this is exacerbated when working individually at initial stages of the Foundations Programme, when students are new to the College, perhaps nervous and unsure of their surroundings. Cooperating closely together provides valuable social bonding at this early stage of their academic career.

The digital platform is one students generally feel very comfortable with, and, working together, students capitalize on each another’s resources and skills, brainstorming and evaluating each other’s ideas. This process enhances their confidence and skills in tackling the IELTS Academic Writing Test, which is the gatekeeper to their Bachelor’s degree, and future academic success.

References

- Anderson, T., & Miyazoe, T. (2010). *Learning outcomes and students' perceptions of online writing: Simultaneous implementation of a forum, blog, and wiki in an EFL blended learning setting*. System, Volume 38, Issue 2, June 2010, pages 185–199.
- Benson, C. (2013) *The iPad: Novelty or Breakthrough for Science Education?* Available online at: <http://scholarworks.montana.edu/xmlui/handle/1/2757>
- CELTA Syllabus (2010), University of Cambridge. Available online at: <http://www.cambridgeenglish.org/images/21816-celta-syllbus.pdf> Retrieved: 29/02/15
- Chiu, M. M. (2000). *Group problem solving processes: Social interactions and individual actions*. Theory of Social Behavior, 30, 1, 27-50, pages 600-631.
- Dillenbourg, P. (1999). *Collaborative Learning: Cognitive and Computational Approaches*. Advances in Learning and Instruction Series. New York, NY: Elsevier Science, Inc.
- Gilksman, S. (2011). *What do students think of using iPads in class?* Available online at: <http://ipadeducators.ning.com/profiles/blogs/what-do-students-think-of>. Retrieved 16 May, 2015.
- Johnson, D., & Johnson, R. (2009). *An Educational Psychology Success Story: Social Interdependence Theory and Cooperative Learning*. Educational Researcher 2009; 38; 365.
- Krashen, S. (1977). *Some issues relating to the monitor model*. On Tesol, 77(144-158).
- Melhuish, K., & Falloon, G. (2010). *Looking to the future: M-learning with the iPad*. Computers in New Zealand Schools: Learning, Leading, Technology, 22 (3).
- Nunan, D. (1982). *Collaborative Language Learning and Teaching*. Cambridge, England: CUP.
- O'Sullivan, A. (2004) *Reading and Arab College Students - Issues in the United Arab Emirates Higher Colleges of Technology*. Available at: http://bath.academia.edu/AndrewOSullivan/Papers/1056633/Reading_and_Arab_college_students_Issues_in_the_United_Arab_Emirates_Higher_Colleges_of_Technology Retrieved 27/11/15
- Peel, R. (2014). *Chapter Seven: Challenge and Change in Online Reading: Learner's Perceptions of Textbooks and Reading Online*. Using Technology in Foreign Language Teaching, pp.134 – 161. Newcastle-upon-Tyne, UK: Cambridge Scholars Publishing.
- Prensky, M. (2001). *Digital natives, digital immigrants: Part 1. On the Horizon*. MCB University Press, Vol. 9 No. 5, October 2001.
- Richards, J. C. (2006). *Communicative Language Teaching Today*. New York: Cambridge University Press.
- Roseth, C. J., Johnson, D. W., & Johnson R. T. (2008). *Promoting early adolescents' achievement and peer relationships*. Psychological Bulletin, 134, 223–246.
- Storch, N. (2005). *Collaborative writing: Product, process, and students' reflections*. Journal of Second Language Writing 14 (2005), pages 153–173.
- Weider, B. (2011). *iPads could hinder teaching, professors say*. Chronicle of Higher Education, 57(28), A22-A23.
- Wertsch, J. V. (1985). *Vygotsky and the Social Formation of Mind*. Cambridge, MA: Harvard University Press.
- Woykes, E. (2011). *The pros and cons of iPads in the classroom*. Available online at: <http://www.forbes.com/sites/elizabethwoyke/2011/01/21/pros-and-cons-of-ipads-in-the-classroom/> Retrieved 16 May, 2015.

The English Language Needs of Different Stakeholders at Universitas Muhammadiyah Malang Indonesia: The Ethnographic Study

Dwi Poedjiastutie
Curtin University of Australia
The School of Education
Faculty of Humanities

Abstract

The Language Centre at Universitas Muhammadiyah Malang (LC UMM) provides all new enrolled students' admission into the English Program and is conducted under the auspices of English for Specific Purposes (ESP). This program is for all the freshmen enrolled at UMM during the first year (two semesters) of their study. Students of all departments take different ESP courses depending on their majors. The research objective of this study is to examine the English learning needs of different stakeholders at UMM. These stakeholders include learners, teachers, and employers. It compares the results from classroom observations, faculty interviews, and student interviews in order to gain an overall understanding. As it is crucial to identify the English learning goals of different stakeholders at UMM, a critical exploration of the shared culture of the stakeholders is more crucial to identify since these current shared cultures potentially inhibit or support the development of English programs at UMM and possibly make it difficult to achieve the English learning goals set within the university. For that purposes, an ethnographic approach was employed. In this approach the socio-cultural context remained integral to the study. Given that the focus included organizational cultural groups, it was critical to capture their understandings, beliefs and practices with regard to English language needs. The findings of the present study suggest that at the level of the university, the faculty, and at the classroom level, shared cultures of the stakeholders need improving.

Keywords: Stakeholder Shared Culture.

Introduction

Universitas Muhammadiyah Malang (UMM) is the biggest private Muslim university in Java. It is located in Malang, the second largest city after Surabaya in the East Java province of Indonesia. As part of their commitment to improvement, this university currently undertakes international collaboration with a range of organizations inside and outside of Indonesia. This includes collaboration with Erasmus Mundus, the Australian Consortium for 'in Country' Indonesian Studies (ACICIS), Peace Corps America, BGP Engineering Netherland, and the American Indonesian Exchange Foundation (AMINEF).

One of the important UMM a commitment is to prepare students for employment. Graduates are expected to be able to function in workplaces immediately upon graduation and to be ready to accept the challenges that exist within these. In a study conducted by the English Department (ED) at UMM, it was reported that on completion of their first degree the majority of graduates intended to seek a job. More than 80% indicated their intention to go into jobs as teachers of English in a range of settings (primary school to university level). A large number of these were, and continue to be, accepted into English language teaching positions at the Language Centre (LC UMM). Less than 20% of graduates indicated that they would go into other professions.

The LC UMM provides all new enrolled students' admission into the English Program which is conducted under the auspices of English for Specific Purposes (ESP). ESP is for all the freshmen enrolled at UMM in their first year and take different ESP courses depending on their majors. For example, students from the Mathematics Department study English for mathematics purposes. Thus, the ESP program provides English skill development so that students can read and comprehend English text books, journals, and articles in their disciplines. In addition, by undertaking this course, students build their spoken and written English communication skills.

However, senior management of the LC UMM have expressed dissatisfaction with the ED graduates' English Language proficiency and consequently their capacity to carry out their duties as teaching staff of the university (Bestari, 2010). This concern centres on their ability to perform the required tasks. It is vital that future English teachers develop the competencies needed for the task of teaching, so that they can adapt to the kinds of challenges that will occur in their careers.

To address this concern, several steps have been taken to improve ED UMM students' level of English competence including redesigning the English curriculum. However, there has been no systematic analysis of students' needs or efforts to tailor the curriculum or the classroom instruction to address the particular needs of UMM teaching graduates. This indicates that a systematic and rigorous evaluation, a needs analysis, should be conducted. An NA needs to be administered in order to improve the English curriculum and raise the level of graduate English language proficiency. The use of such an evaluation is supported in the literature. Long (2005), for instance, claims that:

In this era of globalization, there are growing demands for accountability in public life, including in education. In foreign and second language teaching, one of several consequences is the increasing importance attached to careful studies of learner needs as a prerequisite for effective course design (p.1).

As demonstrated from the range of studies outlined above, NA procedures involve gathering data from a variety of sources in order to develop an appropriate curriculum, for example, the type and content of lectures, the types of reading and writing assignments, and the study skills needed in order to be successful. NA procedures may also involve administering questionnaires and interviews with students, teachers and employers to determine their perceptions, observation of students in classes to observe how well they are

able to carry out their assignments, examination of their lecture notes, essays, and so on, to determine their difficulties, as well as tests of different kinds to determine the students' level of proficiency in reading, writing, and note taking (Mackay and Palmer, 1981).

NA may be large-scale, quantitative studies providing descriptive information of the stakeholder needs or small-scale, qualitative studies with more interpretive information, or a combination of both. An example of the former is the NA undertaken by Evan and Green (2007). This was a large-scale, multifaceted investigation into the language problems experienced by Cantonese-speaking students at Hong Kong's largest English-medium university. Baseline data for the study were derived from a survey of almost 5000 undergraduates from all 26 departments in the university. The findings from the student survey were illuminated by data from interviews with students and discussions with and surveys of departmental program leaders. The benefit of using a multi-method approach informs the current study.

In contrast to this large scale and largely quantitative study, Jaso-Aguilar (1999) utilised small scale qualitative research methods providing interpretive results when undertaking her needs analysis. Jaso-Aguilar (1999) highlights that the use of qualitative research methods take into account the social context of people's lives by allowing them to express their own voice and needs, as opposed to the researcher's or the institution's. The use of several qualitative research methods, multiple sources, and triangulation in her study allowed for the inclusion of learners' voices. These voices clearly disagreed with institutional needs and interpretations. Jaso-Anguliar's study suggests that it is useful to identify the language needs of the learners outside the workplace and to create a curriculum that will truly engage them in language learning. In this way they can be supported to become active and functional members of an English-speaking society. The value of using multiple sources and methods under an overarching qualitative approach are suggestions have also been used to inform the current study.

In addition, the approach used in the current study is based on the work of Holliday (1995) who employed ethnography in his study. Unlike surveys, ethnography has the potential to yield rich data and it also allows for deep exploration of the context. Contextual factors are keys because similar solutions might work in one context but might not be applicable in another.

The Research Methods

Ethnographic Approach

Ethnography is primarily concerned with writing about people (Burns, 1997). In a broad sense, ethnography encompasses any study of a group of people for the purpose of describing their socio-cultural activities and patterns. Based on this definition, several important features of ethnography were adopted in the present study.

First and most importantly, by following an ethnographical approach, the socio-cultural context remained integral to the study. Wolcott (1997) reflects, "The culture of any society [which] is made up of the concepts, beliefs, and principles of action and organization of the society in the context" (p. 238). In this study, the socio-cultural context was UMM and the focus was how it operates as an organization and how the members function and relate to one another. Therefore, as an ethnographic study, relevant phenomena were observed and described within the context of UMM. This also involved interviewing the various stakeholders, employers, teachers and students, to explore their ways of thinking, their habits and beliefs about the target phenomena, namely the English learning needs of students as they pertain to the English curriculum. Given that the focus included organizational cultural groups - students, administrators, and lecturers - it was critical to capture their understandings, beliefs and practices with regard to English language needs.

Another important aspect of ethnographic research is the contextualization of the data. Thus, the data for the current study was interpreted only in the context of the UMM where it was collected. As an ethnographic study, the concern is not about the generalizability.

Research Participants

The first group from UMM consisted of the key policy makers from the various faculties. There were six who were willing to take part in an individual interview. The group varied in their teaching experience, academic qualifications, their English backgrounds, and overseas experience. However, most had been faculty members for more than twenty years.

Secondly, at the time of this study, there were 74 teachers involved in ESP teaching at LC UMM. 22 were full-time teachers and 52 were part-time teachers. For this study, 15 were willing to be observed while teaching (twice) and then to be individually interviewed post observation. Eight of these were part-time and seven were full-time teachers. Nine had three and more years teaching experience. Six had master's qualifications either from Indonesia or from overseas and eleven had a bachelor's qualification.

The third group of participants were students, specifically those drawn from that group enrolled in the ESP program in the academic year 2012/2013 including those in different majors. They participated in focus group discussions. The potential group from which this sample was drawn consisted of more than five thousand students enrolled in Bachelor Degree programs. The sample was taken from all faculties. At the time of the study, the majority were of the age range 18-22 years.

Findings and Discussions

Shared Culture of the Employers

Due to the crucial role of English in this institution, there is a need to improve this group's shared culture which may potentially be inhibiting the development of the ESP program.

Need for Improved Coordination

Coordination is the act of having different groups of people within institutions work together for the desired goals of an organization. From the analysis of the interviews with the employers, it appears that there is a need for improved coordination within the institution in the way that the ESP program is delivered. The Director of LC has the main responsibility for the ESP program at UMM, yet this is done without the continuous support and regular coordination with other employers and people within the organization. As the Director indicates:

So that the teaching and learning of ESP becomes the main job for LC and it is becoming the main responsibility for me as the director of LC to equip the students with the English competencies (M, DLC).

Despite the enormity of the task, the Director often acted independently of the LC staff and of the ED UMM more generally. For example, in the recruitment of LC teaching staff, no meeting was conducted with the Dean of the Faculty before the recruitment process began. Yet such a meeting would enable the Director to receive feedback about what is currently needed from the ESP teachers, criteria that applicants should be expected to meet, and ways that may be employed to meet current needs. This situation is exacerbated in that the only communication about recruitment is conducted through the 'Surat Tugas' a letter which instructs committee members about their responsibilities during each stage of the recruitment process. At the same time, however, the recruitment committee members were usually ESP teachers and ED UMM lecturers and none of the members were the Deans or Faculty staff.

For this and other reasons, the recruitment process came under criticism from the employers. They highlighted the inconsistency inherent in it. For instance, they described how some of the committee members nominated potential candidates and some just gave scores for the candidates to the Director. Once this stage was complete, the decision was made by the Director of LC. The Deans of the Faculties are not notified which candidates are accepted and only the Head of General Administration is informed so that a contract letter can be issued.

This lack of coordination is exacerbated by poor communication. For example, the employers identified a lack of communication about the contract status of ESP teachers. Some of the employers thought that the ESP teachers and the 'come and go' system that underpins the appointment process may affect the students' learning outcomes. They were particularly concerned as they felt that the limited extent of the contracts impacted on the teachers' professional development, and therefore, in turn on the students' progress. They further indicated a need for discussion with the policy makers about this situation. For example one employer described it in the following way:

As far as I'm concerned, the professionalism in teaching will actually be shaped after teaching for several years. One-year contracts do not suffice to train fresh graduates to teach English. The teachers in LC by design should not come and go. It might be possible for the Institution to recruit a number of staff at a time, and then along the way select the most qualified teaching staff for at least a three-year contract or more (LZ, VDFAH).

The need for better coordination was also highlighted in relation to department staff returning from overseas study who are expected to assist with ESP teaching. This occurs across the university.

OK, I agree. The Language Centre is the unit that is formally responsible for the English teaching. But English teaching is not only done and is not only controlled by the Language Centre only but also from the faculties and there should be cooperation, a program from the university that later the LC teaching staff are not only stationed in the centre but they are distributed across departments in this university. So this guides us, the policy guides us I mean that in the future it is not only the Language Centre as such but it is also the responsibility of the department so in this context the main role of the Language Centre is to stimulate teaching and learning English so that it is run very well. This is an attempt to stimulate the departments and also the stakeholders there (M, DLC).

However, not all teachers are given a chance to teach ESP in their department. Only those who were willing to teach and who asked to teach English classes by the LC are allocated ESP schedules. Even then, the LC often fails to allocate such staff ESP classes often because of a lack of systematic coordination between different entities in the university.

Simplification of the Problems

The employers were concerned about the students' English learning outcomes. The students' poor English achievement may be due, at least in part, to the mismatch between the classroom instruction and the assessment. During instruction, students were taught either ESP or General English. At the end of their ESP class semester, they were given a series of tests in speaking, reading, listening and writing. Next, and before they were granted their English

Diploma Certificate, they should undertake a TOEFL. Their TOEFL results were reported to the Faculties. Almost all the Deans of the Faculties viewed the TOEFL scores as the only indicator of students' English proficiencies. The majority of students' TOEFL results after the ESP completion were often below 450. No consideration was given to their class tests.

However, the employers did not appear to systematically or comprehensively investigate the data to back up their opinions. Despite the low level of student English achievement, employers did not regard this as a major problem and instead, they perceived that no complaint from the students was an indicator that there were no problems with English teaching.

There is no complaint from our students about the performance of ESP teachers from LC. I assume that our students do enjoy ESP classes. I admit that we have never supervised ESP classroom activities. We just observe students' scores and never conduct any written feedback. But I think it is a good idea to do so (MS, VDFK).

In addition, the number of students participating in international study is also seen as an indicator of the success of the ESP teaching program. However, the employers did not seem to consider the ratio of student overseas participation to non-participation.

Whilst the employers held these views, the data showed that students' success was actually influenced by a range of factors. For example, several highly motivated students improved their English competencies by attending private English courses, or from being active in English clubs and programs offered by the university such as the debating forum. Those who chose to take risk in the process of learning English appeared to achieve well. These students were also more ready to participate in overseas competitions and programs.

The employers also tended to draw on the experiences of just a few highly proficient students, such as those described above, without understanding the complexity of the situation. Because of this, employers did not consider factors such as student lack of motivation, poor learning approaches, or uninteresting teaching methods.

The second indicator that ESP is appropriately conducted is the increasing number of students participating in international forums. One of students in Animal Husbandry Department is chosen as a representative of Indonesian university, along with the other three students from other prominent universities, they participated in an international conference. They presented their papers in English. Without English proficiency, I doubt that the students would be granted the opportunity. (LZ, VDFAH).

The Teachers' Shared Culture

Teachers' Attitudes and Beliefs

It was clear from the classroom (and outside the classroom) observations and teacher interviews that the teachers' attitudes and beliefs strongly impacted on the way they taught and interacted with their students. It was also clear that their cultural values influenced the decisions they made and the actions they took. In this way, the teachers' beliefs were reflected in their classroom pedagogical practices.

The shared culture of the LC appeared to evolve through the way that the beliefs are being inculcated from the old teachers to the new and inexperienced ones. This is because the new teachers teach and perform roles in the ways they were taught.

For example, some teachers described how they believed that new students are young and naive and, therefore, they need to be told what to learn and that teaching them requires starting at the beginning level. Due to this, what was particularly noticeable in many of the observed lessons is that the teachers took a central role. This is a situation similar to that described by Richard and Bolkhe (2011) - the teacher was the one who dominated the talking

during the lesson, the teacher was the one who did most of the presentation and the explanation of the tasks, and the teacher was the one who was preoccupied with control, order, and class management.

In many ways these actions are a reflection of the type of education they themselves had experienced (Coleman, 1996). In Indonesia generally, and at UMM especially, it is a common expectation that teachers are those who provide knowledge to students. Furthermore, students are seen more as knowledge receivers rather than active participants in knowledge creation.

It is clear from the evidence of the interviews and observations that these perceptions influenced how the teachers and students behaved in the current context. For example, at UMM, teachers explained teaching materials and the students were expected to listen to their teachers. Furthermore, during their explanation teachers took a position in the front of the classroom reflecting the central position that teachers seemed to believe they hold. Even though the teachers employed a variety of teaching techniques, in general this did not change the centrality of the teachers' roles. This is because teacher-centred class instruction is deeply embedded in Indonesian school settings; this type of instruction has become a part in the Indonesian school culture (Bjork, 2005).

Other aspect of learner centre was rarely found in many ESP classrooms at UMM. Carter (1983) and also Hutchinson and Waters (1987) claim that learning centre is an integral part of ESP teaching. For example, it also appeared that the teachers had difficulty dealing with mixed ability classes and with students who had a range of interests. For example, in several of the classrooms observed, the teachers were not seen to provide materials with different levels of difficulty. That is, they continued to give the same materials to students regardless of their levels of English competence. In two different interviews the teachers justified the use of GE materials for all of the students in this way:

GE is the basic competence that students should possess before ESP (AKD).

The GE materials were given because students were still in their first semester. I want to push the materials gently and not to shock them with direct introduction of ESP. As I said before, attracting them not frightening them with difficult materials was a very important step (HA).

Treating all students in the same way may result in the more proficient learners becoming bored or the lower level learners not understanding the materials. In both situations, the results can be demotivating for the students.

Activities of the Teachers

The observations made during this ethnographic study were not always conducted in classrooms. The incorporation of observations made outside of the classrooms provided a more comprehensive picture of teachers' attitudes to and understandings about the ESP program and about teaching more generally. Observations were undertaken in the LC office where teachers usually meet informally before and after teaching. The LC office was divided into three large areas. The first area was about 13 by 8 metres. This area was the main or front office where the Director of LC and the consultants spent their office hours.

The middle area was the smallest area which was about 4 metres in length and 8 metres in width. This office was equipped with computers where staff could do both their administrative and academic tasks. The back area was as big as the main office. In this area LC staff, both full-time and part-time teachers got together while waiting for their teaching schedules or when they have finished their teaching.

After lessons, some teachers chatted casually whilst some others appeared to check their students' work. Some accessed the internet either for social networking or as a way to search for teaching materials. Sometimes the teachers also shared and reviewed their

understandings about classroom pedagogy as a small informal group. For example, they were observed to discuss the progress of the teachers' chapters they were writing for the ESP books.

Other administrative tasks that staff were regularly observed to be involved in included TOEFL test administration, designing workshops and organising the ESP graduation. This range of teacher activities was partly due to the expectation of the Director of the LC, but also because in this institution, every activity other than teaching brings further financial rewards. Therefore, doing such tasks enabled teachers to supplement their income which has been reported elsewhere to be low (i.e., teachers are underpaid in Indonesia, Yuwono & Harbon, 2010).

One of the consequences of such a degree of activities is that many staff noted that due to the amount of time they spent on administrative and academic tasks, they had little time for reflecting on their teaching.

I have to do a lot of jobs at the one time which overwhelms me. It makes me feel that I didn't do my best so I need to...yuck, this job is overwhelming (FBS).

The number of administrative tasks teachers had to undertake was further exacerbated by the reporting mechanisms at UMM. Whilst teaching is monitored externally by the Badan Kendali Mutu Akademik (BKMA) or the Quality Assurance Bureau, the teachers' performance of administrative tasks was usually monitored by and reported to the Director of the LC.

Thus it appears that the challenges of ESP teaching are not solely due to teachers and students knowledge and skills. The many other tasks teachers must perform also impact on their teaching.

Other Teaching Behaviours

As noted above, it was found that few ESP teachers provided teaching materials for students of different levels. Only a couple of teachers reported asking their students what sort of materials they needed or wanted to learn about, or, in fact, asked any questions that might help to inform their teaching. Instead intuition based teaching was observed to occur in many of the classes. This is teaching whereby students are provided with teaching materials based on an instinctive feeling of the teacher rather than on an evaluation of students' proficiencies and needs.

The teaching that occurred in the classes was also observed to be fast-paced and reactive to curriculum and assessment requirements, rather than responsive to learner needs. It demonstrated a general lack of reflection about pedagogy. For instance, classroom observations showed the teachers moving quickly from one topic to another, without sufficiently checking what students had grasped or that everyone in the class had the knowledge or skills required for the next topic. One such example of this took place in a speaking class. The teacher asked students to practice a role play between a manager and a job applicant. She then gave ten examples of the English expressions and questions that interviewers commonly asked in a job interview. However, the teacher discussed the topic only quickly and briefly. It seemed that students' lack of understanding was not her concern.

The following transcription was from the observation of this session and shows the rapidity and density of the information that the teacher gave to the class.

Teacher: Question no one: Hello, how can I help you?

Question number two: What kind of job are you applying for?

Do you understand question number two: What kinds of job are you applying for?

Number three: Describe about yourself

Describe about yourself, well my name is Nisa, I'm from Kalimantan,
I love to work hard bla..blah..blah..

What experiences have you got? Means work experience. For example, I'm familiar
to

Operate the computer; I'm skilful to manage the people.

What are your good points and what are your bad points?

Good points, you can say your strengths, positive points...

And then your bad points (RR).

From the observations and information provided in the interviews by the teachers, it does seem that professional development is needed by staff to understand the process and time required for English language development. There also appears to be a need for the goals of ESP teaching program to be redefined into more operational and achievable outcomes, taking into account student expectations and desires for the future. Teachers will then require appropriate training for these goals to be achieved.

The Students' Shared Culture

Students have multiple and significant reasons for learning English. Further many expressed a high level of motivation and interest in learning English. They were also able to articulate their needs and made suggestions of how the ESP program could be enhanced. Despite these positive outcomes, observations made in the ESP classrooms suggested a contradiction between the students' expressed desires and beliefs and their behaviour.

Initially the classroom observations were made to obtain data to support the teachers' perceptions about needs. However, in the process of doing so observations were made about the way students' responded to teachers' questions and tasks, their interactions both with their classroom teachers and their classmates, and other actions that highlighted behaviours that provide important background information about the students as stakeholders.

From the observations conducted in the classes, socialising was found to be a significant part of almost all the ESP classes. The students were seen talking to friends, either those who sat next to them or even farther away. They were heard talking about matters which were often not related to the topics discussed in the class. Peers were also observed talking in Bahasa Indonesia whilst waiting for the teacher to call their names and check their attendance. They also talked in the middle of the lesson such as when a teacher assigned one of the students to read a paragraph projected onto the white board from her laptop. In fact, all the informal talking that was observed was in Bahasa Indonesia.

From the interviews with the teachers about the class situation, the reason the teachers did not seem to take any steps to prevent this behaviour was because some teachers were new and inexperienced and while others considered that reprimanding the students' unruly behaviours would result in lower attendance rates in their classes.

It was observed that students frequently came late to class. The degree of lateness varied from 5 minutes to almost an hour. When they did arrive, some students went directly to find seats and others greeted their teachers. If students were more than 15 minutes late, they would use the Muslim greeting '*Assalamualaikum*'. The custom is those who hear the greeting have to respond in the same way and if many students came late, there were continual stops. In addition to this disruption, late-coming students who did not know the topics being discussed in class often asked questions of their peers who sat next to them and this resulted in additional classroom noise.

Despite some of the problems that were observed to occur, the students were noted to participate actively in their classes. This was demonstrated in the way the students asked questions of the teachers or of their friends, in the way they engaged during group discussion

tasks, in group presentations, and also how they responded to teachers' questions. Overall, they appeared enthusiastic to engage in class discussions. They also appeared willing to participate in instructed tasks. In addition, it was also apparent that a number of students prepared for the lesson tasks before class. However, when teachers pointed it to a particular student to answer a specific question, others who did not get a turn appeared to hide themselves from the teacher's sight. Thus it appears that group work might be one way to further encourage participation, if only that it enable a classroom atmosphere to be less threatening.

Conclusion

The shared cultures of each stakeholder should be considered improving to help better administration of ESP programs at UMM. For the employers, the suggestion is that there should be a coordinated systematic approach to improving students' ESP learning outcomes. By doing this, it is expected good teaching strategies can be implemented and the development of ESP enhanced.

The teachers shared cultural and pedagogical understandings, incorporating their attitudes and beliefs particularly in relation to the key roles they have as teachers, the tasks they need to perform as teachers, and their teaching behaviours.

It is clear that to further enhance the students' success in English learning, some of the behaviours observed in the classrooms need to change.

The employers can play a crucial role in improving the ESP program at UMM. A powerful person at the top, or a large enough group from anywhere in the organization, decides the old ways are not working, figures out a change vision, starts acting differently, and enlists others to act differently. If the new actions produce better results, if the results are communicated and celebrated, and if they are not killed off by the old culture fighting its rear-guard action, new norms will form and new shared values will grow.

The employers should invest future visions and understand why the change is needed and will be more invested in its success. They will better understand what is required of them and will be more committed to taking action. Instead of being the recipients of change, they will become the drivers of change.

References

- Benesch, S. (1996). Needs analysis and curriculum development in EAP: An example of a critical approach. *TESOL Quarterly*, 30(4), 723-738.
- Bestari (2010). Kemampuan mengajar dosen LC. *Bestari Bulletin*.
- Bjork, C. (2005). *Indonesian education: Teachers, schools, and central bureaucracy*. New York and London: Routledge.
- Burns, R.B. (1997). *Introduction to research methods*. (3rd ed.). Australia: Longman.
- Carter, D. (1983). Some propositions about ESP. *The ESP Journal*, 2, 131-137.
- Coleman, H. (Ed.). (1996). *Society and the language classroom*. Cambridge: Cambridge University Press.
- Dudley-Evans, T., & St John, M.J. (1998). *Developments in English for specific purposes*. Cambridge: Cambridge University Press.
- Evans, S., & Green, C. (2007). Why EAP is necessary: A survey of Hong Kong tertiary students. *Journal of English for Academic Purposes*, 6, 3-17.
- Holliday, A. (1995). Assessing language needs within an institutional context: An ethnographic approach. *English for Specific Purposes*, 14(2), 115-126.
- Hutchinson, T. & Waters, A. (1987). *English for specific purposes: A learning-centered approach*. Cambridge, Cambridge University Press.
Doi: 10.1017/CBO9780511733031
- Jaso-Aguilar, R. (1999). Sources, methods and triangulation in needs analysis: A critical perspective in a case study of Waikiki hotel maids. *English for Specific Purposes*, 18(1), 27-46.
- Long, M. H. (2005). *Second language needs analysis*. Cambridge: Cambridge University Press.
- Mackay, R., & Palmer, J.D. (1981). *Languages for specific purposes: program design and evaluation*. Rowley, Mass: Newbury House Publishers.
- Richard, J.C. & Bolkhe, D. (2011). *Creating effective language lessons*. Cambridge: Cambridge University Press.
- Wolcott, H.F. (1997). Ethnographic research in education. In Jaeger, R.M. (Ed.), *Complementary methods for research in education* (pp. 327-353). Washington, DC: AERA.
- Yuwono, G. & Harbon, L. (2010). English teacher professionalism and professional development: Some common issues in Indonesia. *Asian EFL Journal*, 12 (3), 145-163.

Enhancing Vocabulary Retention of Children with ADHD via Total Physical Response

Rajabi Peiman, Noori Masoome, Darakhani Leili

Azad University, English Department, Malayer, Iran

Abstract

The focus of this paper is put on enhancing ESL vocabulary retention by hyperactive children. The paper explores the process of teaching English vocabulary to hyperactive children who experience difficulties in vocabulary retention due to attention deficit and hyperactivity disorder problems. The author considers the process of second language vocabulary learning for children with ADHD in terms of motivation problems and learning preferences. The ESL methodologies that can be applied effectively addressing such learner's needs and the rationale of their choice are then argued for. Examples of activities that will help recall of ESL vocabulary by children with ADHD are also discussed within the framework of this paper.

Keywords: Hyperactive Children, Vocabulary Retention, Total Physical Response Method

Introduction

As the statistics shows, about 5-10% of school-aged children experience learning and social functioning problems caused by ADHD in the US and around the world (Flick, 2010, p. 23). This in turn implies that there will be at least one or two ADHD students needing special teachers' assistance in every classroom, highlighting the necessity to devote close attention to this issue.

General thought and understanding insinuate that the majority of ADHD children do not require special educational services per se and therefore can receive competent education in general school settings. However, nearly all children with ADHD need specific adjustments and accommodations regarding the organization of their learning process in order to make it productive and successful.

Although sometimes unintentional, the lack of teachers' awareness or access to the know-how resources can result in their being unable to manage their ADHD students properly. The focus of my paper is teaching vocabulary as a necessary sub-skill in English as a second language (ESL) to ADHD students, who, in spite of their circumstances, can be successful language learners. The premise of this paper is that the specific ESL teaching processes that work effectively for such learners will benefit all students, thus creating a successful learning experience for all.

Review of Literature

What is ADHD?

ADHD is a neurodevelopmental disorder affecting both children and adults. It is described as a “persistent” or on-going pattern of inattention and/or hyperactivity-impulsivity that gets in the way of daily life or typical development. Individuals with ADHD may also have difficulties with maintaining attention, executive function (or the brain’s ability to begin an activity, organize itself and manage tasks) and working memory.

There are three presentations of ADHD:

- Inattentive
- Hyperactive-impulsive
- Combined inattentive & hyperactive-impulsive

What is the DSM-5?

The *Diagnostic and Statistical Manual of Mental Disorders, Fifth Edition*, (DSM-5), published by the American Psychiatric Association is the guide that lays out the criteria to be used by doctors, mental health professionals, and other qualified clinicians when making a diagnosis of ADHD. The DSM-5 was updated in 2013 and made changes to the definition of ADHD that will affect how the disorder is diagnosed in children and in adults.

What symptoms must a person have for a diagnosis of ADHD?

In making the diagnosis, children still should have six or more symptoms of the disorder. In older teens and adults the DSM-5 states they should have at least five symptoms.

The criteria of symptoms for a diagnosis of ADHD:

Inattentive presentation:

- Fails to give close attention to details or makes careless mistakes.
- Has difficulty sustaining attention.
- Does not appear to listen.
- Struggles to follow through on instructions.
- Has difficulty with organization.
- Avoids or dislikes tasks requiring a lot of thinking.
- Loses things.
- Is easily distracted.
- Is forgetful in daily activities.

Hyperactive-impulsive presentation:

- Fidgets with hands or feet or squirms in chair.
- Has difficulty remaining seated.
- Runs about or climbs excessively in children; extreme restlessness in adults.
- Difficulty engaging in activities quietly.
- Acts as if driven by a motor; adults will often feel inside like they were driven by a motor.
- Talks excessively.
- Blurts out answers before questions have been completed.
- Difficulty waiting or taking turns.
- Interrupts or intrudes upon others.

Combined inattentive & hyperactive-impulsive presentation:

- Has symptoms from both of the above presentations.

Foreign language learning is indisputably more demanding for hyperactive children than for other children. In the past, the specific learning difficulties of these learners, contributing to the high level of challenge, often led to the students' exemption from foreign language instruction. In the era of globalization, the knowledge of foreign languages becomes increasingly important. The command of English in particular is largely considered a key competence, the lack of which may deprive individuals of equal opportunities in education and at the workplace.

Educational policy makers in many countries are well aware of the above mentioned context and therefore insist on the right of hyperactive children to have opportunities to achieve

their full potential including foreign language learning. Many European countries, are now introducing new legal regulations related to the education of hyperactive children. As a result, the teachers are made legally responsible for accommodating the needs of hyperactive children in their instruction, even if they often lack expertise in the given area (www.dystefl.eu).

The Importance of Vocabulary

Vocabulary is central to English language teaching because without sufficient vocabulary students cannot understand others or express their own ideas. Wilkins (1972) wrote that “. . . while without grammar very little can be conveyed, without vocabulary nothing can be conveyed” (pp. 111–112). This point reflects my experience with different languages; even without grammar, with some useful words and expressions, I can often manage to communicate. Lewis (1993) went further to argue, “lexis is the core or heart of language” (p. 89). Particularly as students develop greater fluency and expression in English, it is significant for them to acquire more productive vocabulary knowledge and to develop their own personal vocabulary learning strategies.

The process of EL vocabulary learning by children with ADHD

The problem with ADHD student’s ESL vocabulary learning is partly derived from their problem in attention focus on the receptive skills. This in turn, is the result of a weak span for auditory verbal information that causes problem with both listening and reading comprehension. Even if the ADHD child is interested in what is being read or heard, he may often only be able to catch some unimportant words that grasps his attention. But if the key vocabulary is presented in an interesting way and reinforced several times, the child with ADHD is more likely to grasp the essential vocabulary material to be learned and subsequently recalled later.

For greater vocabulary input enhancement, a multiple sourced input of vocabulary is to be utilized, rather than the monotonous repetition of the new vocabulary (Mapou, 2009).

As Stockman (2009) points out, the more connections and attention stimuli, the more likely an ADHD student will be to remember the vocabulary input.

For example, while getting acquainted with a new word, the child with ADHD should hear the word, see its spelling and the picture representing its meaning, see and touch the object that this word denotes (when possible), get an idea of its function in a sentence, or ideally in a real situation with a number of examples.

At the elementary level, the examples of some vocabulary that are related to life experience of the ADHD children, would be effective. For example, “Anton can play basketball”, “Rita can sing”, Anya can dance”, can make children with ADHD feel more self-confident. When doing this, the teachers provide vital pedagogical and psychological support, creating an atmosphere of success and corroboration, which is so vital for these children.

To establish the “insider knowledge”, about the abilities of these children, the teacher can talk to them during the breaks, or any other time he had a chance. (Kuczula, 2010, p. 18).

As noticed by Nixon and Richardson (2004) teachers should be qualified and have knowledge about ADHD in order to be able to identify the symptoms of this disorder in his or her classroom. Symptoms of ADHD usually become visible when the child goes to school, so the teacher should be able to easily recognize them and help the child to overcome his or her difficulties during the learning process, by choosing the most appropriate method of teaching.

The teacher and his or her competence has a great influence on learners' success and their behavior during the lessons.

TPR as a method of teaching vocabulary to ADHD children

The most appropriate method of teaching English vocabulary to ADHD young learners is Total Physical Response (TPR), because of many reasons. First of all, it reduces the stress level of students who are learning a language which is very important especially for ADHD learners who usually suffer from stress and low self-esteem during lessons. This method enables them to feel more comfortable in the classroom. As noticed by Larsen - Freeman (2008) Total Physical Response allows students to speak only when they are really ready to it so that they do not feel anxious and without anxiety, the retention of words would be enhanced. He also contends that: "Another way to relieve anxiety is to make vocabulary learning as enjoyable as possible." (Larsen - Freeman 2008:114). One of the techniques that can be used to achieve this effect is using commands, by the teacher, sometimes funny ones, to direct children's behavior, such as these:

- touch your friend's ear
- run around your chair,
- clap your hands three times,
- take your book
- run to the blackboard
- take your pencil to the right hand etc.

Then, when students become ready to speak they can say commands to direct their peer's behavior. Students are not forced to anything in this method and as noticed by Larsen - Freeman (2008) "Feelings of success and low anxiety facilitate learning of new vocabulary" (Larsen - Freeman 2008: 114). So, all students can benefit from it, especially ADHD ones.

Moreover, as ADHD students are hyperactive, they cannot sit in one place without moving. Thus, any form of physical activity is advisable for them, and this method provides it. By moving during their learning process they can not only ease the tension and release their emotions, but also integrate with their friends. What is also worth mentioning, ADHD learners may feel better during physical tasks, because they are treated in the same way as other students and their learning difficulties and disabilities are less visible. All students do the same physical activities and ADHD children do not feel worse.

Students with ADHD, have also problems with concentration and sustaining their attention. As noticed by Lengel and Kuczala (2010)"Though no one particular existing formula can be used to determine how often students need to move, evidence is making it clear that movement allows students to refocus and strengthen their ability to pay attention. Researchers at the University of Illinois found that school –age students were better able to allocate attentional resources following vigorous walking." (Lengel – Kuczala 2010: 3). So thanks to the movement while learning, the attention span which is much lower in ADHD children than in other students, can enlarge and the learning process is then more effective and brings more benefits to these learners.

Another good feature of this method is that vocabulary is taught in a form of pictures, real objects and action, what is very important for ADHD students who are usually visual learners, it makes them remember new vocabulary for a longer period of time and their learning process is more natural and is comparable to their acquisition of their mother tongue vocabulary.

We are of the opinion, that also Suggestopaedia can be used to teach ADHD young learners new vocabulary, because it provides relaxation to students during learning by listening to classical music. ADHD learners may calm down and absorb the new words better and in a more pleasurable way thanks to this method. This method also includes the use of some visual materials and posters which facilitate learning of the new vocabulary. Armstrong (1999) believes that drama may be a good technique from Suggestopaedia for young ADHD learners. The teacher wears a special costume or presents a puppet show in order to introduce the new words. It is a good way to increase children's interest and attention because then the students will remember them for a long time. We contend that a good activity especially for ADHD children's vocabulary learning may be role play, which is typical for Suggestopaedia. Children can work in groups with their friends, and everybody has a different role to play, what may be a really interesting activity. Children need to be focused on their role and it is a pleasurable way to learn the new vocabulary of a second language.

Using the above methods by the teachers may help ADHD students to absorb new words. What is also important, all the students in the classroom, also those without problems, may benefit from this type of teaching. We are of the opinion that teachers can mix these two methods to achieve best effects or can use some techniques of these methods during lesson when children's attention becomes lower.

Vocabulary activities

1. Action Verbs – based on the TPR method.

This exercise gives a great outlet to students while teaching directly or revising, but at the risk of their energy getting out of hand. It is important to factor the mood of the class into the task procedure, but the benefits of a controlled lesson should be evident in students overall progress.

- Teach a short list of verbs (jump, run, smile, jump, swim, fly etc), presenting each verb with a corresponding action or gesture. (Students stand around in a circle and repeat the words and the actions after the teacher). Do it several times.
- Teach or review the names of three to five animals with the help of pictures and (or) gestures.
- Divide students into four or three groups.
- Give each group a name, e.g. "Tigers", "Elephants", "Cats", "Bears"
- Give commands to the groups randomly, e.g. "Tigers, jump!", "Elephants, run", "Bears, say: ROOOAAAAAAR!", "Cats say: MEEEW!" etc. Children perform a corresponding action and repeat the utterances after the teacher.
- Gradually increase the tempo of your commands. The game usually gets a little bit wild at the end which makes it even more fun for the children, but the teacher needs to be

Enhancing Vocabulary Retention of Children with ADHD via Total Physical Response

aware and notice that moment approaching, bringing the activity to an end soon afterward.

- This activity is usually very dynamic; children are to move around a lot while practicing the new vocabulary. In that lies the importance for ADHD kids learning, as they focus their attention on both the actions and the words, many enjoy shouting them out, energy over spilling. If the groups are not very big, you can have each student give one command to the group he or she belongs to, and perform it altogether. As a follow up, teach your students to correctly answer questions as: “What can tigers do?”, “What can bears do?” and the like. Students generate answers along the lines of: “Tigers can jump”, “Bears can run” etc.

To give them further practice, have the students seated in a circle with you. Then start clapping, not very fast, but with a particular rhythm. Let the students clap with you and then start speaking as if chanting. Students repeat after you.

T: What can tigers do?

Ss: What can tigers do?

T: Tigers can jump.

Ss: Tigers can jump.

T: (asking the student- next to him (her)): What can bears do?

Ss (all): What can bears do?

S1: Bears can swim.

Ss (all): Bears can swim.

S1: What can cats do? (to some other student sitting next to him (her)).

Ss: What can cats do?

S2: Cats can run.

Ss: Cats can run (and so on).

Students keep generating sentences and clapping till everyone in the circle has finished. From my experience, ADHD children, being kinesthetic learners, react well to a rhythm and are easily motivated to participate. However, it is important not to start the speaking part of the activity with these students as leads; it normally takes them a little more time in comparison to the other students to properly understand what needs to be done in such tasks.

2. “Simon Says” – Vocabulary Review- (based on the TPR method)

The famous game “Simon Says” works surprisingly well with the English teaching repertoire. This activity is fun and based on sustaining participant’s attention. It consists of a series of commands which students are to follow only if the command is preceded by the words “Simon says”. As an example from my class:

- Have all students stand in a circle.
- Teacher prompt: “Simon says jump”. “Simon says run”. “Sit!” (In general, students who have problems with attention deficit are likely to follow the last 'incorrect' command also. But gradually they re-adjust and start paying closer attention to what their teacher says.)
- Ask different students take turn leading the games.

3. “Chase The Fly Away!” (Vocabulary Review)-based on the TPR method.

This exercise is also fun, and the teacher's enthusiasm can be very infective on students’ participation level.

- Have your students seated.
- Ask them to close their eyes and imagine that they have a fly over their head. (Produce a buzzing noise to make it more realistic)
- Tell them the fly is very annoying and how it will try to sit on them all the time. They should chase it away with a hand, but only when the teacher informs where the fly is. But they should not open their eyes.
- Teacher makes a strong buzzing sound and then suddenly stops to say: “The fly is on your nose!” “The fly is on your arm!” “The fly is on your leg!” etc. Students try to chase the fly away from the corresponding body parts.

This activity forces students to concentrate on their teacher's commands. Moreover, with their eyes closed, they are not distracted visually. They cannot see the other pupils to judge who fails to perform the task, while the teacher can easily tell who needs more help with the vocabulary review and which vocabulary items are to be reinforced.

Methodology

Firstly, the study conducted a quantitative research in the form of a questionnaire distributed among teachers with expertise in teaching EL to children (under 12) on the nature of ELT teaching methods and how they contribute to vocabulary retention of hyperactive children. Then, Primary and secondary sources were used to conduct a desk research, library sources, internet sources, document reports, websites and papers. Finally, Total Physical Response has been identified as the best ELT method, to improve vocabulary learning and retention of hyperactive children.

Findings

The findings revealed that from among methods used by ELT teachers to improve the vocabulary retention of hyperactive children, total physical response was considered to impact most positively. The quantitative study concluded that 45 percent of teachers who had taught children for more than 15 years believed in the positive impact of TPR activities on vocabulary learning and retention of hyperactive children.

The study has examined some common ELT methods that teachers use and their impact on vocabulary retention of hyperactive children. Many acknowledge the potential that total physical response and imperative verbs have on improving this retention.

Discussion

We found that there is a positive association between hyperactive children's language proficiency in general, their vocabulary learning and retention in particular and total physical response as a method of English language teaching, applied by ELT teachers. The data collected from the questionnaires distributed among sixty five experienced EL teachers of Jihad Daneshgahi Language Institute in Arak city in Iran, showed that 45 percent of ELT teachers who had taught children English for at least fifteen years, clearly asserted that imperative verbs and physical activity, as the outstanding characteristics of Total Physical Response, did the best for improving the vocabulary learning and retention of hyperactive children.

Conclusion

65 experienced EL teachers who had taught children English for more than fifteen years clearly stated that TPR (Total Physical Response) as a well-known English Language Teaching method creates an enjoyable and active ELT class for both children with attention-deficit hyperactivity disorder and those without this disorder.

References

- American Psychiatric Association (2013). *Diagnostic and statistical manual of mental disorders (DSM-5)*, Washington, D.C.: American Psychiatric Association.
- Armstrong, Thomas. (1991). *ADD /ADHD Alternatives in the Classroom*. Association for Supervision and Curriculum Development Alexandria, Virginia, USA.
- Flick, G. L. (2010). *Managing ADHD in the K-8 Classroom*, 23.
- Kuczala M. (2010). *The Kinesthetic Classroom: Teaching and Learning Through Movement*. Corwin and Regional Training Center.
- Larsen – Freeman, D. (2008). *Techniques and principles in language teaching*. Second Edition, Oxford University Press, Lengel, Tracil.
- Lengel T, Kuczala M. (2010). *The Kinesthetic Classroom : Teaching and Learning through Movement. Thousand Oaks (CA): Corwin Press*.
- Lewis, M. (1993). *The lexical approach: The state of ELT and the way forward*. Hove, England: Language Teaching Publications.
- Mapou, R. L. (2009). *Adult Learning Disabilities and ADHD: Research-informed*. Assessment, 156.
- Nixon G, Richardson R. (2004). *Attention Deficit Hyperactivity Disorder (ADHD). A Practical Guide for Schools*. South Eastern Education and Library Board.
- Stockman, I. J. (2009). *Movement and Action in Learning and Development: Clinical Implications for Pervasive Developmental Disorders*, 12.
- Wilkins, D. (1972). *Grammatical, situational and notional syllabuses*. In Association Internationale de Linguistique Appliquée (Ed.). Proceedings of the 3rd.

Pedagogical Knowledge as a Way out of the Beginning ESL Teacher's Stress and Exhaustion

Rajabi Peiman, Darakhani Leili, Noori Masoome

Azad University, English Department, Malayer, Iran

Abstract

The current environment of the ESL classes of institutes, in which EFL teachers work, often places the ESL beginning teachers under stress. This stress can be defined as the result of imbalance between the demands that are placed on them in their classrooms and the resources that the particular teacher, has for coping with these demands. Those teachers, who experience continued stress, often start to feel burn-out and the burn-out leads to leaving the profession. Emotional exhaustion, depersonalization and loss of feelings of personal accomplishment are considered to be the three components of this burn-out. From among latent changes, reciprocity and pedagogical knowledge, as the assets of teaching and the factors that would support them, in their time of stress and exhaustion, pedagogical knowledge has been selected to be examined here. It would help beginning ESL teachers to get rid of the obstacles which prevent them from enjoying their job and doing their best in arriving at the goals of ESL teaching and learning as a necessity of the life these days.

Keywords: Beginning Teachers, Pedagogical Knowledge

Introduction

In recent years, pedagogical knowledge, has been a focus of research in the literature of teacher knowledge (Magnusson, Krajcik & Borko, 1999; Shulman, 1986). Findings yielded by the research of pedagogical knowledge help researchers deepen their understanding of teacher knowledge in specific areas such as mathematics (Marks, 1990) and science (Lee and Luft, 2008). They also help to professionalize teaching by setting standards in teacher education programs.

In the United States, due to growing number of immigrants, English as a second language (ESL) has always been an essential and important course for English language learners (ELL) and good English is a pathway to academic success and good job opportunities for ELL students.

It is commonly recognized that pedagogical knowledge is essential to develop teachers' knowledge and to prepare novice teachers for effective teaching (Grossman, 1990). However, a survey of the literature reveals little research on pedagogical knowledge and teacher education in the area of ESL.

Review of Literature

What is pedagogical knowledge?

Research has shown that one of the factors that enable effective teachers is their rich Pedagogical Knowledge (Loughran, Berry, & Mulhall, 2006), a knowledge that is built up over time and experience. This form of professional knowledge unique to each teacher can only be gained through teaching practice. The academic construct of pedagogical knowledge is recognition that teaching is not simply the transmission of concepts and skills from teacher to students, but rather, a complex and problematic activity that requires many and varied on-the-spot decisions and responses to students' ongoing learning needs. While much has been written about the nature of Pedagogical knowledge since Shulman first introduced the concept in 1987 and its elusive characteristics have led to much debate, there are still gaps in our knowledge about teacher development of Pedagogical knowledge. However, the work of Magnusson, Krajcik, and Borko (1999) is helpful in clarifying this special form of a teacher's professional knowledge by proposing that Pedagogical knowledge is made up of four components. In their view, an experienced teacher's Pedagogical knowledge encompasses his/her:

- Knowledge of curriculum (what, why and how to teach),
- Knowledge of assessment (why, what, and how to assess),
- Knowledge of students' understanding of the subject, and
- Knowledge of instructional strategies.

Planning a course

Teachers are often asked to work with a course plan that already exists. This may be an explicit document generated within the institution, or a more implicit Statement such as a prescribed course book. But, sometimes, individual teachers or groups of colleagues need to plan

a course themselves. These suggestions should help you to plan a coherent learning experience for your students.

- Know your learners.
- Formulate aims and objectives.
- Name the strands of the learning experience.
- Consider the language content.
- Think about topics and text types.
- Think about processes.
- Decide on a sequence for the course elements.
- Get feedback on your draft course.
- Develop a formal, public document.
- Remain open to change.

Choosing the right course book

A good course book makes a tremendous difference to a program. For learners, it can give confidence and reassurance, as well as the opportunity to look ahead and see what's coming next. For teachers, it offers a framework for course planning as well as lesson-by-lesson support. Sometimes we are told which book to use; but often, individual teachers or groups of colleagues are asked to choose a main book for their program. The following suggestions should help you to evaluate potential course books and choose the best one for your learners.

- Get a clear picture of your students' language learning needs. Then see how well the course book matches them. Is the emphasis on grammar, vocabulary, pronunciation etc. appropriate?
- Examine the syllabus organization. Contents pages usually make it clear whether the book is primarily organized according to a structural, functional, lexical or indeed a multi-syllabus.
- Think about how your students want to learn. Ask yourself whether the methodology suggested by the course book is in fact appropriate for them.
- Examine the subject content of the book. Language learning is part of a wider educational experience, and the thematic content of a course book should be considered from this perspective. A book should provide stimulation and cognitive challenge, without causing bewilderment or offence. This can be a difficult balance to strike when books are written in one cultural context and used in another.
- Think about the kind of classroom interactions you want to have. Find out whether the book is likely to provide them. For example, how much time might your learners like to spend working individually? In pairs or groups? as a whole class? And what sort of tasks would they get most benefit from? By looking at the activities suggested in the course book, you will see how your learners might be relating to each other as they use it.

- Consider your own needs as a teacher. Course books are usually accompanied by teachers' guides, which vary a great deal in the level of support they provide. Ask yourself whether you can empathize with the advice given in the teachers' guide, and what you can learn from it. Will you feel comfortable adopting the roles the teachers' guide suggests for you?
- Consider the needs of your institution. Course books usually come as part of a package that includes teachers' guide, workbooks, cassettes, video...if not more. Is your institution able and willing to purchase all of these? If not, you will need to assess whether the course book is in fact usable without all the other elements of the package. You should also consider how long your new purchases will be expected to last!
- Work with colleagues to choose your course book. Where a book is being chosen for a whole teaching team, it is important for all colleagues to be involved.
- Ask your learners about their criteria for a good course book. This will give you a useful picture of their priorities.
- Whatever evaluation techniques you use, keep your own situation firmly in mind. There are no inherently good or inherently bad course books, only course books which are better or worse in particular situations. Make sure any evaluation you undertake reflects your own priorities.

Designing your own materials

Despite the excellent range of published materials available, and all the options that we have for flexible use of these, there are still occasions when teachers need or prefer to make their own materials. The following suggestions will help you make the most of whatever resources you have available to create materials that will enhance your students' learning experience.

Appearance

- It is advisable to take care over the appearance of your materials. Not everyone has access to desktop publishing software and laser printers, but we can all make good use of layout, white space and print sizes to make our materials look attractive. By taking care over your materials, you show learners that you have a serious attitude to preparing for the class.

House identity

- All your materials should include a heading with the name or logo of your institution, course or class gives them a more 'official' stamp and is another encouragement for learners to take them seriously. Learners are more likely to file numbered, titled handouts than odd sheets of paper!
- Have clear objectives for the materials. If you push yourself to say explicitly what your objectives are, it is more likely that you will be able to develop materials that are relevant

to your learners' needs and to the objectives of your course. As you write the materials, the objectives are a reference point to make sure your materials stay on task.

- Choose source material carefully. Your materials will probably be designed around some sort of written or spoken source text. Make sure this is appropriate for the learners in terms of topic and level—and that it lends itself to an exploitation that is relevant to your learners' needs and the objectives of the course.
- Design appropriate tasks. The tasks in your materials need to be appropriate to your course objectives and your learners' interests. They should also be manageable within the time frame you have available. Learners should enjoy them in their own right and/or be able to see why they are important for a future goal.
- Include clear rubrics. Almost all materials include instructions to the learners, and those you make for your own class should not be an exception. Especially for a complex series of tasks, learners can find it reassuring to see all the steps written down in the materials.
- Make the materials personally relevant to the learners. Designing your own materials is an ideal opportunity to build on what you know about your learners' lives and interests. For example, if you are choosing a reading text about a famous person, might it be someone your learners are particularly interested in?
- Ask a colleague to help you. If you get into the habit of asking a colleague to look over drafts of your materials, you will get valuable ideas and suggestions. Mistakes are also far less likely to slip by two people! And if you offer to do the same for your colleague, you will get exposure to even more materials design ideas.
- Consider sharing your materials with colleagues. The time involved in designing your own materials can really pay off when a group of colleagues are sharing materials around. Between you, you can build up a bank of materials for use with particular types of classes. These can be stored in a central area in the staff room. Knowing that others will use your materials is also an excellent incentive to make them as complete and clear as you can.
- Ask learners to contribute source texts. Learners could be asked to search out texts which interest them on particular topics, and you could incorporate some of these into future materials. ESP (English for Special Purposes) learners especially may appreciate the chance for this sort of input—they, after all, know exactly what sort of texts they need to deal with.
- Ask learners for feedback on your materials. They may be particularly willing to give this if they see it as an opportunity to influence the materials you and your colleagues will be designing for them in the near future. It can be very satisfying to learners to see their suggestions and views incorporated into materials.

Planning the Assessment

This section describes different steps within the planning process, highlighting issues most relevant to the assessment of ELLs.

Test Purpose

The purpose of a test must be clear in order for valid interpretations to be made on the basis of the test scores. Tests have different purposes. For example, one test may be used to evaluate students' readiness to advance to the next grade, while another evaluates students' need for remediation. It is also important to outline the specific interpretations that will be made based on the scores. For example, tests used as a criterion for high school graduation will affect students differently than tests designed to inform instructional decisions.

Defining the Construct

A second criterion for validity is a precise and explicit definition of the construct the test is intended to measure. For K-12 assessments, state standards underlie the test specifications.

Sometimes other state documents, such as curriculum frameworks, may clarify knowledge and skills stated in the standards. When defining a construct for an assessment to be given to ELLs, consider in particular how English language skills interact with the construct. For example, when defining the construct for a mathematics test, consider whether it is intended to be a test of mathematics, in which case the test should require no or absolutely minimal English proficiency, or a test of the ability to do mathematics within an English-language educational environment, in which case the ability to comprehend word problems in English may be part of the construct. Similarly, those who define the construct should pay attention to how much of the vocabulary of the discipline in English is to be viewed as part of the assessment.

Defining English proficiency as part of a target construct for an assessment in mathematics or science is neither right nor wrong. It is essential, however, that these definitions be explicit. Furthermore, even if English proficiency is part of the construct, take care to define what level of English proficiency should be expected of students. When defining the linguistic demands to be included in the construct, make an effort to include professionals with backgrounds in educating ELLs.

Developing the Assessment Specifications

Assessment specifications define the test content and explain how that content will be assessed. Assessment specifications also provide a link between a state's content standards and the items or tasks that appear in a particular test. ELLs will therefore, considering ELLs during the initial development of assessment specifications is utterly important. The following points relevant to ELLs should be addressed when writing K-12 assessment specifications.

- **Domain of Knowledge and Skills**

States are likely to have documented content standards for the subject area to be assessed. States may also provide performance standards and other documents that define the domain and their expectations for student achievement. Test developers should review these documents carefully and note the degree to which each standard calls for the ability to read, write, speak, or listen in English.

- **Number and Types of Items or Tasks**

In general, all other things being equal, tests with more items will supply more reliable scores.

- **Relative Weights of Tasks and Skills**

The weight of a task or content category is generally decided by the importance of the assessed task relative to the other tasks on the test and the degree to which the tasks tap content described in the state's standards.

- **Assessment and Response Forms**

Assessment specifications describe how the tasks will be presented to the students and how the students are expected to respond.

The Role of Subject Matter Knowledge in Teaching

Helping students learn subject matter involves more than the delivery of facts and information. The goal of teaching is to assist students in developing intellectual resources to enable them to participate in, not merely to know about, the major domains of human thought and inquiry. These include the past and its relation to the present; the natural world; the ideas, beliefs, and values of our own and other peoples; the dimensions of space and quantity; aesthetics and representation; and so on. Understanding entails being able to use intellectual ideas and skills as tools to gain control over every day, real-world problems.

Philosophical arguments as well as common sense support the conviction that teachers' own subject matter knowledge influences their efforts to help students learn subject matter.

Conant (1963) wrote that "if a teacher is largely ignorant or uninformed he can do much harm" (p. 93). When teachers possess inaccurate information or conceive of knowledge in narrow ways, they may pass on these ideas to their students. They may fail to challenge students' misconceptions; they may use texts uncritically or may alter them inappropriately. Subtly, teachers' conceptions of knowledge shape their practice--the kinds of questions they ask, the idea they reinforce, the sorts of tasks they assign.

Here it focuses on what Shulman (1986) calls subject matter content knowledge. What teachers need to know about the subject matter they teach extends beyond the specific topics of their curriculum. Shulman (1986) argues that "teachers must not only be capable of defining for students the accepted truths in a domain. They must also be able to explain why a particular proposition is deemed warranted, why it is worth knowing, and how it relates to other propositions" (p. 9). This kind of understanding encompasses an understanding of the intellectual fabric and essence of the subject matter itself. For example, while English teachers need to know about particular authors and their works, about literary genres and styles, they also need to know about interpretation and criticism (Grossman, in press). A history teacher needs detailed knowledge about events and people of the past but must also understand what history is: the nature of historical knowledge and what it means to find out or know something about the past. Scheffler (1973) writes that this kind of subject matter understanding "strengthens the teacher's powers and, in so doing, heightens the possibilities of his art" (p. 89).

That teachers may hold such goals for student learning that grow out of their study of subject matter does not, however, dictate a particular pedagogy. In helping students develop such understandings, teachers may play a variety of roles and draw on a variety of knowledge and

skills. Teaching styles and the manner in which teachers organize their classrooms may also vary.

The knowledge of instructional strategies

The NTC introduces the tool in workshops that establish a common language among educators regarding effective methods for language-focused instruction. District teachers, mentors, and administrators use the six key strategies to identify good teaching skills that help them plan lessons that are accessible to a range of students.

- The first of the six key strategies is vocabulary and language development, through which teachers introduce new concepts by discussing vocabulary words key to that concept. Exploring specific academic terms like algorithm starts a sequence of lessons on larger math concepts and builds the student's background knowledge.
- The second strategy is guided interaction. With this method, teachers structure lessons so students work together to understand what they read—by listening, speaking, reading, and writing collaboratively about the academic concepts in the text.
- The third strategy is metacognition and authentic assessment. Rather than having students simply memorize information, teachers model and explicitly teach thinking skills (metacognition) crucial to learning new concepts. Research shows that metacognition is a critical skill for learning a second language and a skill used by highly proficient readers of any language. With authentic assessments, teachers use a variety of activities to check students' understanding, acknowledging that students learning a second language need a variety of ways to demonstrate their understanding of concepts that are not wholly reliant on advanced language skills.
- The fourth strategy is explicit instruction, or direct teaching of concepts, academic language, and reading comprehension strategies needed to complete classroom tasks.
- The fifth strategy is the use of meaning-based context and universal themes, referring to taking something meaningful from the students' everyday lives and using it as a springboard to interest them in academic concepts. Research shows that when students are interested in something and can connect it to their lives or cultural backgrounds they are more highly motivated and learn at a better rate.
- The final strategy is the use of modeling, graphic organizers, and visuals. The use of a variety of visual aids, including pictures, diagrams, and charts, helps all students—and especially ELL students—easily recognize essential information and its relationship to supporting ideas. Visuals make both the language and the content more accessible to students.

Methodology

To prove the positive impact of pedagogical knowledge on decreasing the stress of novice ESL teachers, a two-semester qualitative research was conducted which described and analyzed the events in a foreign language teaching practice course, focusing on the meanings of those events to the participants (student-teachers, teacher-educator and teacher education researcher).

First phase:

The instruments used in the first phase of the research were first, the teaching practice course content to study the theoretical foundation and course objectives of the teaching practice classes. Secondly, the video recording of the two-semester teaching practice class observations to describe the development of the process of the teaching practice. Thirdly, audio recordings of the interview with teacher-educator in order to investigate the teacher-educator profile and his teacher education conceptions.

Second phase:

At the end of the two semesters of teaching practice classes, firstly, some questionnaires were distributed among student-teachers to make their profile and analyze their conceptions about EL teaching and learning. Secondly, student-teacher reflective journals to analyze proposed activities and thirdly, student teachers' reflection sessions on their teaching practice. Fourthly, video-recordings of reflective sessions to reflect about teaching practice actions and results.

Findings

The findings revealed that student teachers could make a better association between their theoretical knowledge and their experiences in teaching, after two semesters of pedagogical knowledge classes which were taught by experienced teacher educators.

Discussion

The student teachers taught ESL in their teaching practice classes. These teaching practices were video recorded by the researcher and a copy was given. Then, in some reflective sessions these observations were discussed and video recorded again with reflection on their pedagogical practice in order to investigate student teachers decrease of stress and then, doing better in solving problems regarding such topics as teaching approach, activities and objectives, teacher and student roles, teaching grammar, teaching vocabulary, and self-evaluation.

After two semesters of teaching and experiencing in teaching practice classes and under the control of the experienced teachers, the student teachers did really better in linking their experiential knowledge to their theoretical knowledge, as a result of the decrease of their stress and exhaustion.

Conclusion

The purpose of this study is to investigate the impact of beginning teachers' pedagogical knowledge and skills during their beginning of teaching. The results of this study showed that the beginning teachers' pedagogical knowledge decreased significantly novice teacher's stress and helped them continue their job as a teacher successfully and self-confidently.

References

- Conant, J. (1963). *The education of American teachers*. New York: McGraw-Hill.
- Grossman, P. L. (1990). *The making of a teacher: Teacher knowledge and teacher education*. NY: Teachers College Press.
- Kenji, H and Lee, L. J. (2009). *Guidelines for the Assessment of English Language Learners*, Stanford University. https://www.ets.org/s/.../ell_guidelines.pdf
- Lee, E., & Luft, J. (2008). *Experienced secondary science teachers' representation of pedagogical content knowledge*. *International Journal of Science Education*, 30(10), 1343-1363. <http://dx.doi.org/10.1080/09500690802187058>
- Loughran, J., Berry, A., & Mulhall, P. (2006). *Understanding and developing science teachers' pedagogical content knowledge*. Rotterdam: Sense
- Magnusson, S., Krajcik, J., & Borko, H. (1999). *Nature, sources, and development of pedagogical content knowledge for science teaching*. In Gess-Newsome, J. (Ed.), *Examining Pedagogical Content Knowledge: The Construct and its Implications for Science Education*. Dordrecht: Kluwer Academic Publishers.
- Marks, R. (1990). *Pedagogical content knowledge: From a mathematical case to a modified conception*. *Journal of Teacher Education*, 41(3), 3-11. <http://dx.doi.org/10.1177/002248719004100302>
- Shulman, L. S. (1986). *Those who understand: Knowledge growth in teaching*. Educational Researcher.
- Scheffler, I. (1973). *Reason and teaching*. New York: Bobbs-Merrill.
- Wharton, S and Race, P (1999). *500 Tips for TESOL (Teaching English to Speakers of Other Languages)*. London and Sterling: Kogan Page.

Impact of Permanent Vocabulary on Acquiring a New Language – An Empirical Evaluation

¹Kausar Saida and ²Yousuf Khan

¹ Higher Colleges of Technology
Faculty of Liberal Studies
Sharjah, UAE

² Higher Colleges of Technology
Faculty of Business
Sharjah, UAE

Abstract

This paper aims to make a local contribution to the theories that have an impact on the teaching and learning experience of teachers and students. One difficulty that students of non-English-speaking background encounter is related to Phonology. Phonology explains the variations in pronunciation from a number of perspectives. This paper tests dialectic impact on vocabulary assimilation in non-English speaking students whose higher education is in English. Accordingly, standard UK English, as the reference point, is the English dialect against which the research criteria are based. While accents cannot be completely eliminated; an individual's accent is a part of who they are and the cultural influences also have a part to play. However, when learning a new language, the permanent vocabulary (mother tongue) creates inefficiencies in pronunciation of another language. The research question assesses the "*Impact of permanent vocabulary on acquiring a new language*". The theory of Phonology can be evaluated in a number of ways, however, the limited aspect of this research analyses the symptomatic effects of phonemes (syllables). Students are exposed to word complexities. The same students are then asked to pronounce the same words in a symbiotic manner employing syllables (phonemes) to assess any differences. Three hypotheses are tested for significance, i.e. the extent of symbiotic effects on spoken English. Results suggest students are more efficient at pronouncing words symbiotically, employing phonemes (syllables), which then significantly improve word pronunciation and aids in accent reduction. Educators may wish to consider embedding a symbiotic approach to teaching English to non-English speaking students.

Keywords: Phonology, Phonemes, Syllables, English dialects

Introduction

Many languages across the globe share a common ancestry. In linguistics, this ancestry is referred to a genetic relationship that is distinct from its biological equivalence. Thus, a genetic relationship between languages proposes the same linguistic grouping, known as a language family (Nichols, 2012). For instance, Spanish and Italian share their genesis in Latin.

Accordingly, the basis for linguistic commonality can be determined through an analysis of words in the target languages that demonstrate lexical and grammatical similarities (Ruhlen, 1994). However, while research suggests that a historical relationship exists between English and Arabic, nevertheless they are both considered to belong to different language families (Jassem, 2012). Similarities between languages on the basis of genetic relationship can be analyzed from many different perspectives. However, three potential means by which a genetic relationship can be established is, most importantly, through common origin, convergence, and linguistic crossover and borrowing (Yule, 2006). Accordingly the aim of this research is to evaluate the “impact of permanent vocabulary on acquiring a new language”. As such four distinct research objectives are achieved employing the theory of Phonology.

Objective 1 assesses pronunciation of specially selected words that exhibit “aspirated” sounds, i.e. the “*h*” after the first letter as in the word “*kill*” which should be pronounced as “*k^hill*” as opposed to an unaspirated word such as “*skill*”. Moreover, pronunciation of English words, in general, presents added inefficiencies for English language acquirers where the complexity of a word increases the inefficiency. In this regard the use of phonemes assists language acquirers in attaining efficiency in the English language. Accordingly, the efficiency of pronunciation is evaluated qualitatively employing morphological analysis (Fritz Zwicky, 1967, 1969).

Objectives 2-4 employ statistical techniques for evaluating efficiencies in language skills where ex-ante and ex-post assessment of words pronunciation is statistically tested to determine possible significance in the difference between word and phoneme pronunciation. The importance of these tests will demonstrate the efficiency of translation skills in users of the English language.

Theoretical Framework

Theory of Phonology

This paper serves an important utility and essentially tests the impact of permanent vocabulary on the transient stages of acquiring a new language. This is enabled through the theory of Phonology that can be evaluated in a number of ways, however, the limited aspect of this research analyses the symptomatic effects of phonemes (syllables) on acquiring English efficiency predicated by a person’s permanent vocabulary. A group of randomly selected sample of students is subjected to word complexities. The same participants are then asked to pronounce the same words employing syllables (phonemes) to assess any differences in pronunciation.

A phoneme is an abstraction of speech sound. Each abstraction is referred to as a syllable. A group of syllables come together to form a phoneme. For example, the English word “*Respectful*” consists of three syllables: the initial “*ris*” sound, the “*pect*” sound, and the “*ful*” sound (culminating in: *ris-pect-ful*). Note that the syllables in this and many other English words do not always correspond directly to the letters used to spell them (English language contains many words in which some letters are silent e.g. walk and talk where the letter “*t*” is silent). This presents added complexity for those in the process of acquiring English language skills. As such, the next section, the literature review, discusses

relevant and pertinent themes on phonology and its implications for learners of the English language.

Literature Review

Mass movement and convergence of people across the globe due to economic, political and social reasons have highlighted the inefficiencies of linguistics convergence, for instance, due to historical, sociological, and political reasons. As an example, South Asians have a higher control of lexical and semantic effects of their permanent vocabulary on the efficiency of spoken English as compared to, say, Chinese speakers of English (Crystal, 2010).

In higher education in particular, the effects of lexical, semantic and cultural differences present additional inefficiencies in spoken and written English. This is quite apparent in Arabic-speaking students of higher education. However, in a contemporaneous linguistics environment due to globalization, mass movement of people, and the social reliance on technology, has led to unprecedented scale of linguistics convergence (Chambers, 2002; and Baron, 2003).

Tagliamonte and Denis (2008) suggest that the adaptation of own language, and its variation, is reflected in its online use. This social phenomenon (online IT media) is predominantly found in today's youth. The younger members of society are much more "tech savvy" and hence are much more aware of stylistic, lexical and semantic developments in languages that differ from ordinary language. Indeed, Van Herk and OIP (2006) argue that online subcultures exist. Accordingly, users of social media, such as Facebook and Twitter for example, are able to converse more efficiently on platforms employing adapted semantics and lexicons that previously did not exist; say, twenty years ago that do not exist, at least, not in the common vocabulary.

The Process of language Transliteration; Translation; and Formulation

The process of conversion of the source language to a target language passes through two distinct stages to achieve the desired syntactic structure, namely, "transliteration" and "translation". This process eventually results in "formulation", and it is an iterative process that develops over time leading to lingual efficiency (McGinnis, 2001).

Transliteration

The process of transliteration is the like-for-like conversion of words by the perceiver. Transliteration attempts to employ one-to-one correspondence from the source language (SL) to the target language (TL). This process of conversion can have two meanings. Firstly, the word(s) matching that of the TL is sought in the databank (mind) of the perceiver. Secondly, the perceiver converts the word(s) from the SL to the TL, thus converting a whole sentence on a like-for-like basis.

The process of transliteration may cause inefficiency in the conversion process. This inefficiency may be due to multitude of factors but predominantly due to lack of prior knowledge of the TL. Catford (1965) suggests that "In transliteration, SL graphological units are replaced by TL graphological units; but these are not translation equivalents, since they are not selected on the basis of relationship to the same graphic substance".

Translation

Translation may be defined as the replacement of textual material in one language (SL) by equivalent textual material in another language (TL). However, translation is not transliteration (Venuti, 1998). Translation attempts to adopt a meaningful conversion from the SL to the TL. Thus, reciprocal structure on conversion is adopted by the perceiver so that the receiver of the TL can readily understand the message being conveyed.

However, as Culler (1976) points out that "one of the troublesome problems of translation is the disparity among languages. The bigger gap between the SL and the TL, the more difficult

will be the transfer of message from the former to the latter.” Accordingly, translation attempts to give meaning to ideas that formulate in a sentence/paragraph from the SL to the TL, thus leading to formulation and eventual articulation.

Formulation

This process of language conversion is sometimes referred to by linguistics as “formulation” in which the source language has been converted to the target language to a desired degree of efficiency (Garrett, 1975; and Ferreira & Pashler, 2002). Once transliteration has been achieved, the next stage is lingual translation. In executing transliteration and translation, literature suggests that an intermediate stage occurs that enables the planning of the utterance and its eventual articulation. Thus, the cycle of transliteration – translation – formulation is complete when verbal articulation takes place.

Phonetic Complexities

The various theoretical explanations of linguistic inefficiencies due to “convergence, borrowing and common origin” provide some level of understanding and explanation that subsists in the written and spoken abilities of an acquired language (Ruhlen, 1994). One notable outcome of using an acquired language is related to the phenomenon of word-pronunciation. Phonetic complexities are many and varied; however, principle variations include four distinct types of complexities that arise due to:

Evaluated complexities

- Aspirated and Unaspirated
- Multi-Syllable words

Other complexities unevaluated

- Stressed and Unstressed syllables
- Tonality and Tonicity

1. Complexities due to Aspirated and Unaspirated words

The English language is filled with complexities that are confusing at best. The mix of consonants and vowels provide much of this complexity. Additionally, lexical stress on sounds provides further complexity such as in the word “increase”. Lexical stress is phonemic in English (van der Feest & Fikkert, 2015). For example, the noun *increase* and the verb *increase* are distinguished by the positioning of the stress on the first syllable in the former, and on the second syllable in the latter (Jaaskelainen, 2005).

Additionally, some words when used singularly are aspirated but when combined with other letters to form a new word which then are unaspirated. For example, “K^hILL” and “SKILL” and “P^hOT” and “SPOT” where the words KILL and POT are aspirated and SKILL and SPOT are unaspirated (Guillaume, 2011). Accordingly, Objective 1 is evaluated theoretically and that:

Proposition: Acquirers of verbal English language skills demonstrate weak efficiency in recognizing aspirated words.

2. Complexities due to Multi-Syllable words

Like many languages, English orthography can be complex. Orthography relates to a set of conventions upon which a written language is based. Typically, rules for spelling, punctuation, word-breaks, hyphenation, capitalization, and emphasis. Letters such as A, B, and C are referred to as orthographic units (Pitt & Samuel, 1990). Different letters produce different sounds in most cases. However, differences in pronunciation may seemingly not differ such is the case as in the pro-noun Catherine and its other version Katherine (Pitt & Samuel, 1990; Pallier, 1997).

Combinations of letters form words which themselves can be atomised in their equivalent phonemes. Thus, the word “*subjective*” can be expressed in its phonetic equivalent as “*sub-jek-ti*”; hence the word has three syllables. How the phonetic version of the word is

spelt largely rests with the researcher, as long as the phonetic expressiveness is achieved (ClarkYallop & Fletcher, 1995; Cruttenden & Gimson, 2008).

Syllables represent a special case in linguistics. Syllables correspond to the unit of sounds desired from the word. This principle enables the desired phonetic outcome (Cahill & Rice, 2014). Thus, the null hypotheses 1–3 test for homogenous characteristics of respondents in word pronunciation containing three to five syllable phonemes, and that:

Objective 2:

H1_o: Respondents demonstrate no difference in phonetic verbal articulation in three-syllable English words and their equivalent phonemes

H1_a: Respondents demonstrate strong phonetic verbal articulation in three-syllable English words and their equivalent phonemes

Objective 3:

H2_o: Respondents demonstrate no difference in phonetic verbal articulation in four-syllable English words and their equivalent phonemes

H2_a: Respondents demonstrate strong phonetic verbal articulation in four-syllable English word and their equivalent phonemes

Objective 4:

H3_o: Respondents demonstrate no difference in phonetic verbal articulation in five-syllable English words and their equivalent phonemes

H3_a: Respondents demonstrate strong phonetic verbal articulation in five-syllable English words and their equivalent phonemes

Hypotheses 1-3 test specific issues in the efficiency of word pronunciation with their equivalent alternate hypotheses. Additionally, to the stated four objective, an ANOVA analysis tests for the variation in pronunciation efficiency due to word complexity i.e. between groups (the three; four and five syllable groups). Accordingly, hypothesis 4 states that:

H4_o: Respondents demonstrate no difference in verbal articulation across the 3-5 syllable range of phonemes

H4_a: Respondents demonstrate strong verbal articulation across the 3-5 syllable range of phonemes

3. Complexities due to Stressed and Unstressed syllables

A further complexity that arises and creates difficulties for acquirers of the English language is the phenomenon on *stressed* and *unstressed* syllables. Traditionally, a word complexity is measured by the number of syllables it contains (phoneme). As such each syllable in the phoneme is ascribed one of three levels of stress: primary, secondary or unstressed. It is often found that in a complex phoneme, there will be one syllable with primary stress, possibly one syllable having secondary stress, and the remaining syllables are unstressed.

Accordingly, words such as COMMA and LETTER exhibit stressed and unstressed characteristics. In this instance, notice that in the former case, the whole word is pronounced i.e. COM-MA, however, in the latter case the pronunciation creates an unstressed syllable i.e. the word “LETTER” is pronounced as “LET-TA”. Acquirers of English languages must adapt this characteristic in their English language efficiency in proper pronunciation.

4. Complexities due to Tonality and Tonicity

Additional complexity arises due to contrasts involving boundaries between intonation of phrases (tonality), placement of pitch accent (tonicity), and choice of tone or tones associated with the pitch accent in the various dialects of English (Halliday, 1963; Grice, Ridouane and Roettger, 2015). Benward and Saker (2003) suggest that “tonality” is an

organized system of tones (e.g. the tones of a major or minor scale) in which one tone (the tonic) becomes the central point for the remaining tones. In tonality, the tonic (tonal centre) is the tone of complete relaxation, the target toward which other tones lead”. In contrast to Tonality, however, it is suggested that Tonicity relates to the placing of the principal accent on a particular syllable of a word, making it the tonic syllable. This is the domain also referred to as prosodic stress or sentence stress (Bao, 1999). The diagram below is a representation of some important complexities in language acquisition skills.



Diagram 1 - Exhibits a theoretical view of this research. It depicts the complexities and stages i.e. transliteration, translation and formulation, that impact upon language efficiency on conversion between the source language to the target language

Methodology

Data

The primary data for this research has been obtained by a random selection of students in a higher education institute in the UAE. The sample group represents a mix of young male and female respondents. This research is enabled through the collection of primary data and as such some 84 students participated in the research, with the final sample-set comprising 70 participants representing useable data. Data collection was enabled through recording of responses to a set of pre-determined English words which the students were asked to read.

In relation to objective 1, the purpose of the research was to qualitatively determine the ex-ante and ex-post differences in aspirated and unaspirated words. While a qualitative approach is employed in determining the features and characteristics of the responses by participants, nevertheless some simple statistical output enabled a quantified insight in the differences of before-and-after exposure to pre-determined words. The sample words used in this assessment are exhibited in **Table 1** below.

UNASPIRATED WORDS WITHOUT THE /h/	ASPIRATED WORDS WITH THE /h/
CAN	C ^h AN
POT	P ^h OT
KILL	K ^h ILL
TOP	T ^h OP
PILL	P ^h ILL
PAT	P ^h AT

Table 1 –Aspirated and Unaspirated Words

Table 1 (above) exhibits the morphological evaluation of some common English words with their corresponding phonemes. The unaspirated words are constructed in their common nomenclature. The same words are then aspirated with the /h/. Participants are asked to pronounce the unaspirated words without guidance from the researchers. They are then asked to articulate the same words with aspirations with guidance on how these words should be verbally articulated. Both sets of words are then assigned a score based on the quality of the verbal articulation.

In relation to objectives 2-4, data is gathered through quantification of responses to words and phonemes. This quantification was achieved by subjectively evaluating the quality of the responses to the pre-determined set of words ranging from three to five syllables in length. The quantification takes the form of marks from a scale 1-10, 10 being the highest quality pronunciation (Marten et al, 2007). While the quantification of the data may be subjective, rigorous means were adopted in quantification procedures. This included both researchers agreeing to the mark assigned to each respondent. The data gathered was then statistically analyzed to test the relevant set of hypotheses in relation to objectives 2-4.

Tables 2 – 4 exhibit the words employed in testing for verbal articulation efficiency. The tables are so arranged in order of complexity according to phoneme length as measured by the number of syllables they contain. Participants articulate the words and then the corresponding phonemes. The verbal articulations are analyzed and assigned a score ranging from 1 to 10. The scores are then subjected to statistical analysis and hypotheses testing.

WORD	PHONEME
JOURNALIST	JUR – NA – LIST
PRIORITISE	PRY – ORA – TISE
QUINTUPLET	QUIN – TUP – LET
RESPECTFUL	RIS – PECT – FUL
VISUAL	VIZ – U – AL
GASOLINE	GAS – O – LEEN
MAGAZINE	MAG – A – ZEEN

Table 2 - Three syllable words and their corresponding phonemes

WORD	PHONEME
NUMERATOR	NU – MA – RAY – TA
EVAPORATE	EVAP – OR – RATE
DELIGHTFULLY	DE – LITE – FUL – LEE
FUNDAMENTAL	FUN – DA – MEN – TAL
UKULELE	U – KA – LE – LEE
JUBILATION	JU – BI – LAY – SHUN
WATERMELON	WO – TAR – MEL – LON

Table 3 - Four syllable words and their corresponding phonemes

WORD	PHONEME
ACRIMONIOUS	AC – REE – MO – NEE - US
BIOLOGICAL	BI – O – LO – GI – CAL
DIAGONALLY	DI – AG – O - NAL – LY
EVOLUTIONIST	EE - VO – LOO – SHUN - IST
GEOMETRICAL	GEE – O – MET – RI - CAL
HIPPOTUMUS	HIP – PO – PO T– TU - MUS
VOCIFEROUSLY	VO – SIF – ER – US – LY

Table 4 - Five syllable words and their corresponding phonemes

Data was tested for the desired output and consistency. This was achieved through simple IF statement test in Excel that compared the output data to minimum – maximum range of 1-7 since no student was assigned a score greater than 7 in the data. The consistency test was achieved successfully without any further data checking or recourse to data modification.

Research procedures

Objective 1 is achieved through the adoption of Morphological analysis of linguistic efficiency. Recorded transcripts of pre-determined word pronunciation were evaluated for pronunciation efficiency employing unaspirated words. The quality of the pronunciation efficiency was then assigned a score of between 1to10. Respondents were then told how they should re-pronounce each word and were guided as to how the words should be re-pronounced employing aspirated techniques.

Objectives2 – 4 are achieved employing words of three to five syllables complexity and their corresponding phonemes. After evaluation of the recorded transcripts, scores were assigned to the pronunciation of the pre-determined words and their corresponding phonemes in order of word complexity. The statistical procedures adopted in answering the stated hypotheses are based on t-tests and analysis of variance (ANOVA) to test for statistical significance.

Objective 1 - Morphological analysis of linguistic efficiency

Objective 1 is to theoretically determine if improvements are noticeable when participants are asked to pronounce unaspirated words and then aspirated words. A Morphological approach is selected to achieve this task. As a methodology, morphological analysis enables freedom to analyze a phenomenon from numerous perspectives to make sense of that phenomenon (Zwicky, 1969; and Ritchey, 2006).

Fluency in reading should reflect the natural character of what is being read and mimic speech in its articulation and expressiveness. Reading efficiency is only possible if textual perceptions are efficient and little effort is expended in formulating verbal articulation. The level of efficiency in verbal articulation should also extend to unfamiliar words. Therefore, strong decoding skills are essential tools of reading and hence verbal articulation. As such, Morphological analysis lends itself readily to phonetic deconstruction of words that enables an understanding of phonetic articulation (Gut, 2009).

Objectives 2-4 - Statistical analysis of word and phonemes pronunciation

Objectives 2-4 rely on hypotheses testing to answer the main research question through empirical means employing t-tests and ANOVA. Participants are first asked to pronounce pre-selected words that ascend in complexity from three-syllable words to five-syllable words along with their corresponding phonemes. They are then explained how to pronounce the equivalent phoneme for each word. The quality of the words and phonemes pronunciation are assessed for quality and assigned a score ranging from between 1-10. The quantified responses are tested according to the relevant hypotheses stated in the literature review. Each word is tested for statistical significance to determine:

1. Significant in the difference between three-syllable word and phoneme pronunciation employing paired t-test (Hypothesis 1o&1a).
2. Significant in the difference between four-syllable word and phoneme pronunciation employing paired t-test (Hypothesis 2o &2a).
3. Significant in the difference between five-syllable word and phoneme pronunciation employing paired (Hypothesis 3o& 3a).
4. Significant in the difference between word and phoneme pronunciation using ANOVA across the three to five syllable words and their corresponding phonemes (Hypothesis 4o& 4a).

Findings and Results

Findings to Objective 1

Data was collected via a recording medium. Morphological analysis was restricted to vocal analysis of aspirated and unaspirated words using syllables and phonemes. Participants were not told how to read the pre-determined list of words and consequently it was noticed that there was not much variation in the quality of verbal articulation and thus the sample group exhibited a homogenous characteristic. This characteristic indicated a symbiotic effect of the permanent vocabulary (Arabic, the source language) on the target language i.e. English (Munro & Mann, 2005).

The participants were then explained how they should pronounce the corresponding aspirated version of the unaspirated words. Having quantified the responses, a measure of change was noticeable. Table below is a summary of the quantified responses on unaspirated and aspirated words:

Aspirated words average	Unaspirated words average	Improvement in articulation
4.13	5.19	26%

Table 5 – Findings of analysis of unaspirated and aspirated words

The articulation of unaspirated words yielded an average score of 4.13. However, participants average score increased to 5.19 on verbal articulation quality of the same, but aspirated words. This suggests that an increase in verbal articulation quality of 26%. It demonstrates that a simple technique employed widely as a tool for accent reduction has considerable impact on articulation quality of the English language (Pennycook, 1999; and Munro & Mann, 2005).

Objectives 2-4 provide further basis for employing linguistic skills in higher education to enable efficient use of the English language. The use of morphological analysis is extended to the analysis of words and their corresponding phonemes in objectives 2-4.

Results to Objective 2-4

Objectives 2-4 test the verbal articulation quality of familiar and less familiar words among participants. In so doing a picture emerges that demonstrates the impact of word complexity and pronunciation quality. Table 6 (below) shows the results of hypotheses tests for the objectives 2-4.

Type	Hypothesis 1		Hypothesis 2		Hypothesis 3	
	Word	Phoneme	Word	Phoneme	Word	Phoneme
Syllables	3	3	4	4	5	5
Observations	70.00	70.00	70.00	70.00	70.00	70.00
Mean	3.31	4.54	3.34	4.80	3.14	4.84
Variance	0.89	1.09	1.07	1.03	1.31	0.71
Pearson Correlation	0.63		0.51		0.35	
P(T<=t) two-tail	0.00		0.00		0.00	

Table 6 – Results of Hypotheses 1 – 3 exhibiting statistical output comparing *WORD* and *PHONEME* articulation quality

In all three cases the null hypotheses that there is no difference between word and phoneme verbal articulation quality is rejected as in all three hypotheses the significance is $p0.00 < 0.05$ at alpha 0.05 level. This suggests that phonetic nomenclature has an improvement effect on verbal articulation quality. Additionally, the results confirm that there subsists a positive correlation between the three sets of word/phoneme combinations i.e. 3; 4; and 5 syllable phonemes.

Additionally, it appears to be evidence that participants gained substantial efficiency in verbal articulation quality in relation to word complexity i.e. participants articulation improved as the number of syllables in the words increased. In this respect the Mean between the three sets of word/phoneme combinations has gradually increased while Pearson’s Correlation has declined. In the latter case evidence further suggests that the extent of verbal articulation, comparing the words to their corresponding phonemes, has improved significantly. This suggests that the use of phonemes, embedded within English medium education can improve pronunciation quality particularly within higher education.

Analysis of Variance test of Phonemes

Evidence from the data output suggests that participants verbal articulation quality improved and is statistically significant. Results also suggest that verbal articulation quality improved greater as compared with word complexity. Hypothesis 4 is tested employing ANOVA test to evaluate the significance in the difference between the 3; 4; and 5 syllable phonemes articulation quality. Table 7 (below) is a summary of the results output.

SUMMARY

<i>Groups</i>	<i>Count</i>	<i>Sum</i>	<i>Average</i>	<i>Variance</i>
4	69	314	4.55	1.10
4	69	332	4.81	1.04
4	69	335	4.86	0.71

ANOVA

<i>Source of Variation</i>	<i>SS</i>	<i>df</i>	<i>MS</i>	<i>F</i>	<i>P-value</i>	<i>F crit</i>
Between Groups	3.74	2	1.87	1.96	0.14	3.04
Within Groups	194.17	204	0.95			
Total	197.91	206				

Table 7 – Results of ANOVA test comparing 3 – 5 syllable phonemes

Results in Table 7 indicate that $F_{1.96} < F_{crit} 3.04$, therefore, we accept the null hypothesis that respondents demonstrate no difference in verbal articulation across the syllable range of English words and their equivalent phonemes, since the F value of 1.96 is less than the F (Critical) value of 3.04. This suggests that while the mean across the syllable range has improved with word complexity, nevertheless, it is not substantial. Nevertheless, the improvement in verbal articulation has improved substantially across the syllable range.

Conclusion

The finding and results of this research present an interesting and justifiable reason to consider a more enhanced research in the same line of enquiry. The present research considered English language efficiency in participants whose permanent vocabulary is Arabic and are in the process of acquiring higher levels of English language skills. In this research, the theory of Phonology explains the impact of the permanent vocabulary on acquiring a new language and how lingual fundamentals affect language acquisition efficiency. Thus in this research the theory of Phonology is considered appropriate in explaining the barriers to acquiring new language skills

Policy Contribution

The present research covered two important research themes, namely, aspirated words and phonetic expressiveness. The research suggests that the observed phenomenon in this research is worth pursuing further. As such the following recommendations are drawn from this enquiry:

1. Vocabulary improvement techniques have an immediate and possible permanent impact on speech articulation and that awareness techniques of unaspirated and aspirated words help acquires of English to improve their pronunciation quality.
2. Decomposition of words in to their equivalent and corresponding phonemes (syllables) aid English language learners of becoming aware/familiar with phonetic articulation, thus enabling improved efficiency in learning English.
3. Research on phonology suggests that instructions in the use of phonetics should include explicit instruction in sounding out letters and blending letters to form words. Additionally, ongoing instruction in letter-sound correspondences for simple as well as more complex phonics patterns could vastly assist language skills to enable an increase in knowledge of word familiarity, thus further enable articulation improvements.
4. Furthermore, explicit instructions in English mentoring and regular practice in these areas should be encouraged. Students need frequent practice applying vocabulary skills that enables improved efficiency in English. Teaching activities that reinforce instruction in these areas play a key role in promoting students' ability to recognize words automatically.
5. Possible tools that can be used in teaching English language skills could include a range of techniques that encourage learning outcomes (Halliday, 1963; Jassem, 1994, 2012; Gimson, 2008). These could include the following techniques:
 - Clarifying the purpose and goal of instruction at the onset of the lesson
 - Using visual or concrete materials that will make learning the new phonics skill(s) more memorable i.e. Providing direct instruction of letter sounds.
 - Providing direct instruction in decoding of letter sounds in words
 - Planning for guided and independent practice.
 - Planning for student application of new phonetic skills in other contexts.

Additionally, research suggests that educators can use three important key indicators of fluency to assess students' fluency and articulation improvement (Catford, 1965; Clark, Yallop and Fletcher, 1995; Pallier, 1997; Bao, 1999; Cruttenden and Gimson, 2008):

- **Accuracy:** The student's ability to identify words in a text correctly.
- **Rate:** The student's ability to read at a rate appropriate for comprehension.
- **Prosody:** The student's ability to read phrases and with expression that both supports and reflects comprehension of the text.

Limitations of this Research

The limitations of this research principally extend to sample size of the data. However, restriction due to time pressures was also important in limiting the size of this research. Additionally, it would have been preferable to conduct research that included gender difference however this was not possible.

Recommendations for further research

This research has proved to be beneficial in terms of its policy contribution. Later researchers should consider enhancing this research by taking larger sample size that includes gender variable. Moreover, added utility would be gained through acquiring data from a range of educational establishments in the UAE that use English as a medium of teaching.

Additionally, this research could be enhanced by later researchers investigating other, but related areas, issues and themes in acquiring language skills and the process of learning a new language. For instance, later researchers could investigate the role of Tonality and Tonicity and its association with Arabic speaking students acquiring English speaking efficiency.

References

- Ammon, U. (1979). Regional dialects and its language in the Federal Republic of Germany (FRG). *International Journal of the Sociology of Language*, 25-40.
- Ball, M. J. (2010). *The Routledge Handbook of Sociolinguistics around the World*. London: Routledge.
- Bao, Z. (1999). *The Structure of Tone*. New York : Oxford University Press.
- Baron, N. (2003). Why email looks like speech: Proofreading pedagogy and public face. *Language, the Media, and International Communication* (pp. 85-94). London: Routledge.
- Benward, B., & Saker, M. (2003). *Music: In Theory and Practice*. New York: McGraw Hill.
- Cahill, M., & Rice, K. (2014). *Developing Orthographies for Unwritten Languages*. Dallas, Texas: SIL International.
- Catford, J. C. (1965). *A Linguistic Theory of Translation: An Essay in Applied Linguistics*. London: Oxford University Press.
- Chambers, J. K. (2002). Dynamics of dialect convergence. *Journal of Sociolinguistics*, 117-130.
- Clark, J., Yallop, C., & Fletcher, J. (1995). *An Introduction to Phonetics and Phonology*. Oxford: Blackwell.
- Cruttenden, A., & Gimson, A. C. (2008). *Gimson's Pronunciation of English*. London: Hodder Education.
- Crystal, D. (2010). *The Cambridge encyclopedia of language*. Cambridge: Cambridge University Press.
- Culler, J. (1976). *Structuralist poetics: structuralism, linguistics, and the study of literature*. Cornell: Cornell University Press.
- Feest, S. Van der & Fikkert, P. (2015). Building phonological lexical representations. *Phonology*, 32, 207-239. doi: 10.1017/S0952675715000135
- Ferreira, V. S., & Pashler, H. (2002). Central bottleneck influences on the processing stages of word production. *Journal of Experimental Psychology: Learning, Memory, and Cognition*, 28, 1187– 1199.
- Garrett, M. F. (1975). The analysis of sentence production. In G.H. Bower (Ed), *The psychology of learning and motivation*, (pp. 133-175). San Diego, CA: Academic Press
- Grice, M., Ridouane, R., & Roettger, T.B. (2015). *Tonal association in Tashlhiyt Berber: Evidence from polar questions and contrastive statements*. Retrieved from Researchgate Website: <http://www.researchgate.net> (last consulted on 02 June 2015).
- Halliday, M. (2008). *Intonation in English Grammar*. Retrieved from Wiley Online Library: <http://onlinelibrary.wiley.com/> (last consulted on 28 June 2008).
- Jassem, Z. A. (2012). The Arabic Origins of English Pronouns: A Lexical Root Theory. *International Journal of Linguistics*.
- McGinnis, M. (2001). *Variations in the phase structure of applicatives*. Paris: John Benjamins Publishing.
- Nichols, J. (2012). Monogenesis or Polygenesis: A Single Ancestral Language for All Humanity. In J. Nichols, *The Oxford Handbook of Language Evolution* (pp. 558-572). Oxford: Oxford University Press.
- Pitt, M.A., Samuel, A.G. (1990). Attention Allocation during Speech Perception: How fine is the focus? *Journal of Memory and Language*, 611-632.
- Ritchey, T. (2006). Problem Structuring using Computer-Aided Morphological Analysis. *Journal of the Operational Research Society*, 7.
- Ruhlen, M. (1994). *On the Origin of Languages: Studies in Linguistic Taxonomy*. Stanford : Stanford UP.

- Suzanne, V. D., & Paula, F. (2015). Building phonological lexical representations. *Phonology*.
- Tagliamonte, S. A., Denis, D. (2008). Linguistic ruin? LOL! Instant Messaging and teen language. American Speech. In D. Biber, & R. Reppen, *The Cambridge Handbook of English Corpus Linguistics* (pp. 3-34). Cambridge: Cambridge University Press.
- Van Herk, G., & the Ottawa Intensifier Project. (2006). That's so tween: Intensifier use in on-line subcultures, NWAV 35, Columbus, Ohio, Nov. 9-12.
- Venuti, L. (1998). Strategies of translation, In M. Baker (Ed.). *Encyclopedia of translation studies* (pp. 240-244). London and New York: Routledge.
- Yule, G., (2006). *The study of language*, (3rd ed). Cambridge: Cambridge UP.
- Zwicky, F., & A. Wilson (eds.). (1967). *New Methods of Thought and Procedure: Contributions to the Symposium on Methodologies*, Berlin: Springer' ISBN-13: 978-3642876196
- Zwicky, F. (1969). *Discovery, Invention, Research - Through the Morphological Approach*, Toronto: The Macmillan Company

Trends in Library and Information Science Education in Nigeria in the 21st Century

Katamba Abubakar Saka
Federal University of Technology,
Dept. of Library and Information Technology,
Minna. Niger State, Nigeria.

Abstract

The 21st century has permeated every facet of human life (agriculture, health, information, aviation, politics, education, etc) with developments. This paper highlighted the remarkable development and the challenges to library and information science education in Nigeria in the 21st century. Information was obtained or gathered through documentary sources and correspondence with professionals in library and information science field in Nigeria. Remarkable development realised in LIS Education in 21st Century Nigeria include, establishment of more library schools in Nigerian specialized universities. Addressed by this paper also include: review, modification and restructure of LIS curriculum to incorporate ICT and entrepreneurship components; accreditation of LIS programmes in Nigerian universities by National Universities Commission and the Librarians' Registration Council of Nigeria; fields of specialization at Postgraduate level in the areas of library and information science, archival and records management, health information management, information science and library management as well as continuous professional development of LIS Educators. Despite these remarkable developments, challenges exist, thus include: divergent nature of LIS curriculum, location and nomenclature of LIS departments and degree awarded respectively; staff strength at professorial cadre; proliferation of LIS programmes, indifference of library educators towards continuous professional development, inadequate facilities and infrastructure resulting to low level of skills. The paper recommends that; the National Universities Commission (NUC) in conjunction with Librarians' Registration Council of Nigeria (LRCN) in Nigeria should bring into completion the new developed-uniform curriculum for universities offering library and information science programmes. The above parastatals should equally work towards having a uniform faculty/school where LIS department can be located as well as uniformity in the nomenclature of the degree awarded. Lecturers on professorial ranks be attracted/recruited or offered employment in library schools. There should attitudinal change on the part of institutional authorities/ teaching staff towards continuous professional development respectively.

Keywords: Trends, Librarianship, Universities, Nigeria

Introduction

Librarianship as a profession has passed through ages: agricultural or pre-industrial, industrial and post-industrial or information age. The existence of libraries and librarianship as a whole is to provide information to users on request. This is made possible by training the personnel that would later provide optimum services in the area of information acquisition and dissemination. This assertion is linked with the view expressed by Nwokocha, Onwubiko and Unagha (2014) that it is not enough to build and establish libraries but also there should be an institution that will train personnel who will later offer services to library users.

Assessing the history of library and information science education on global perspective, Melvil Dewey led in the establishment of the first library school known as the school of library economy in Columbia college in 1887, later known as Columbia University (Reitz, 2005). After three years, the library school was moved to New York state library in Albany and enrolment of twenty students out of which seventeen were female. Furthermore, new library schools were established in 1890 at the Pratt Institute, Brooklyn; in 1892 at Drexel Institute, Philadelphia; and in 1893 at Armour Institute, Chicago respectively (Issa *et al.*, 2014) in (Fitzgibbons as cited in (Issa *et al.*, 2014)

In Britain, the first library school was established in 1919 at University College, London. The graduate library school was established at Chicago in 1928 and this made library education to take a “professional character model” after school of law and medicine (Issa *et al.*, 2014).

In Africa, the first regional library school was established in Ghana in 1944 with reasonable contribution from Carnegie Corporation in collaboration with the British Government though the library school lasted for one year after which it was closed down. East African library school was established at the Makerere University Uganda in 1963 with support of Kenya, Tanzania and Uganda. Other library schools were established in Senegal in 1963, University of Zambia in 1966, University of Botswana in 1979. A good number of South African universities offered training programmes in LIS at postgraduate level (Issa *et al.*, 2014). (Microsoft Encarta as cited in Issa *et al.*, 2014).

In Nigeria, history of library education could be traced back to UNESCO seminar in 1953 which was held in Ibadan. Part of the identified areas was the establishment of professional training courses in Nigeria. This led to the formation of West Africa Library Association (WALA) and financial support from Carnegie Corporation respectively. As documented in several write-ups, the first library school or Department of Library Science in Nigeria was established at the Institute of Librarianship in the then University College Ibadan in 1959. While the first batch of students were admitted in 1960 for postgraduate Diploma and Master’s degree in less than a decade, Carnegie Corporation sponsored a study on “Library needs for Northern Nigeria” under the leadership of F.A. Sharr and the report recommended that a library school be established in Ahmadu Bello University Zaria which came to existence in 1968, olden as cited in (Saka and Abdullahi, 2007), (Alhassan and Ahmed, 2015).

As at the first conference of the National Association of Library and Information Science Educators (NALISE) with theme on “Education for Librarianship” in 1984, there were six university-based library schools in Nigeria such as: University of Ibadan, Ibadan (1960), Ahmadu Bello University Zaria (1968), Bayero University, Kano (1977), University of Maiduguri, Maiduguri (1978), Imo State University, Owerri(1981) and University of Nigeria Nsukka 1983 (Dike, 2014)

As at 2015, the number of university-based library schools in Nigeria were almost 30 out of which 25 were approved/accredited library schools, though some library schools (e.g Ibrahim

Badamasi Babangida University, Lapai), are yet to commence their programmes (Alhassan and Ahmed, 2015). The new generation of library schools in Nigerian universities according to Issa, Amusa, Aliyu and Ladan (2014) include those of: Federal University of Technology(FUT) Minna; Tai Solarin University of Education; Ijebu-ode, University of Ilorin; Umar Musa Yar’adua University, Katsina; Kwara State University, Malete (Ilorin);Michael Opara University of Agriculture, Umudike; Abubakar Tafawa Balewa University, Bauchi; University of Abuja, Modibo Adama University of Technology, Yola; Baze University, Abuja; University of Calabar; University of Makurdi, etc.

Concept of LIS Education

Library Education within the context of this paper is a professional programme designed to prepare students for degree in Library and Information Science. It should however, be noted that Library Education is offered in Polytechnics, Monotechnics and Colleges of Education in Nigeria for award of certificate of library and information science. With the advent of ICT and realities of information as an important resource and ingredient in the 21st century, six fields were proposed for integration into the LIS curriculum. These fields include: information contents, systems, users and providers, organizations as well as supplemental knowledge skills and practicum, Wilson in (Issa, *et al*, 2014).

In Nigeria, many information professionals are not aware of the development in LIS education, not to talk of the challenges. This paper therefore, aims to examine the remarkable development, challenges to LIS education and proffer practical recommendations in the area that require urgent attention in Nigeria in the 21st century.

Remarkable Development in LIS Education

Find below various remarkable developments that have taken place in LIS education in Nigeria in the 21st century:

LIS Curriculum

The LIS curriculum is subject to periodic review and modification by which addition and restructuring of course contents were made. The National Universities Commission (2014) contains the Benchmark Minimum Academic Standards (BMAS) which most library schools were able to meet. They are at liberty to make addition when they feel necessary. This is because of the employers’ demand and labour market. This is supported by the opinions expressed by Aina (2013) on emerging market courses, Akanwa (2014) on ICT courses and LRCN as contained in Daily Trust (2015) on the new developed LIS curriculum respectively.

According to Aina (2013), the emerging market came to being as a result of the number of librarians produced which outnumber the growth of libraries in Nigeria. As such, library schools should offer emerging market courses (ICT, information repackaging, records management, system analysis and design, marketing, etc). These courses would enable librarians to work in non-library environment considering employers’ demand and the challenges in labour market and because of the “new technological innovation”. In order to have detailed knowledge about courses like information science, library management, library automation, multimedia librarianship and entrepreneurship; there is need for library schools to incorporate courses like: electronic resource management, management of social media tools, web design and management, networks and networking, software design and management, database design and management, innovation and creativity, marketing of library and information products and services (Akanwa, 2014)

However, some of the proposed ICT courses enumerated above have been incorporated into the new developed LRCN curriculum. Thus the LRCN backed up by Decree No. 12, of 1995 states in section 2 (b) p.2 and LRCN (2013) that : “determining what standards of knowledge and skills to be attained by person seeking to become registered as librarians and reviewing these standards from time to time as circumstances may require”. Arising from this legal backing, the LRCN has designed a uniform LIS curriculum for all Nigerian universities running LIS programmes. As contained in the Daily Trust of 22nd July, 2015 p.14 revealed that the LRCN has reviewed and developed new curriculum for library schools in Nigeria aiming at harmonizing the course contents and incorporate ICT components, project management finance, budget and communication skills, information literacy, library architecture, knowledge management and business skills (advocacy, marketing and entrepreneurship etc). The curriculum according to the LRCN spokesman was developed in line with the international best practices. (Daily Trust, 2015, P.14)

Fields of Specialization

The LIS curriculum was designed and developed to have multi-disciplinary fields, market driven as well as having various fields of specialization more especially at post graduate level e.g Postgraduate Diploma in Information Management, Master in Library Science, Master in Information Management (Kalu and Obasi, 2014). There are number of programmes run at Postgraduate levels. For example, University of Ibadan library school runs postgraduate programmes in the following areas

- a) Masters in Library and Information Studies (MLIS) (Academic Master) 3-5 semesters
- b) Masters in Archives, Records and Information Management (MARIM) 3 semesters
- c) Masters in Health Information Management (MHIM) (3-5 semesters)
- d) Masters in Publishing and Copyright Studies (MPCS)(Academic master)

At the Doctor of Philosophy (PhD) programme, there are fields of specialization in Library and Information studies, archives and record management, preservation, conservation, publishing and Copyright studies (Undergraduate and postgraduate prospectus 2011/2012-2012/2013 sessions).At University of Maiduguri especially with the PhD programme, one can undertake research and specialize in any of the following areas: Bibliographic Control and Services, Foundations of Library Science, Information Science, Management of Libraries and Information respectively.

The library schools in specialized universities were not left out in the various fields of specialisation as it affects the LIS program. Thus as part of the major decisions taken at the 376th senate meeting of the Federal University of Technology, Minna on 26th June, 2013 was the consideration and approval of the following postgraduate programmes in LIT department;

- a) Postgraduate Diploma in Library and Information Technology,
- b) Master of Technology (M.Tech) in Library and Information Technology
- c) Doctor of Philosophy (PhD) in Library and Information Technology (FUT Minna, 2015)
- d)

Accreditation of LIS Programmes in Nigerian Universities

One of the features of LIS education in Nigeria in the 21st century is the accreditation issue. Unlike in the 1990s when only National Universities Commission accredits LIS programmes, librarians are now incorporated in the accreditation team. Apart from the accreditation by the supervisory parastatal (National Universities Commission), the LRCN also

carry out the accreditation of library schools. One way by which this is carried out is by including LIS professionals among the NUC accreditation team to every Nigerian university offering LIS programmes. As at October, 2015, LRCN has accredited and approved 25 Nigerian universities offering LIS programmes. The list is below:

S/No	Universities	Approved Programme
1.	Abia State University, Uturu	Library & Information Science
2.	Abubakar Tafawa Balewa University, Bauchi	Library & Information Science
3.	Adeleke University, Ede	Library & Information Science
4.	Ahmadu Bello University, Zaria	Library & Information Science
5.	Ambrose Ali University, Ekpoma	Library & Information Science
6.	Bayero University, Kano	Library & Information Science
7.	Baze University, Abuja	Library & Information Science
8.	Benson Idahosa University, Benin City	Library & Information Science
9.	Benue State University, Makrudi	Library & Information Science
10.	Delta State University, Abraka	Library & Information Science
11.	Federal University of Technology, Minna	Library & Information Technology
12.	Federal University of Technology, Yola	Library & Information Science
13.	Ibrahim Badamasi Babangida University, Lapai	Library & Information Science
14.	Imo State University, Owerri	Library & Information Science
15.	Kwara State University, Ilorin	Library & Information Science
16.	Madonna University, Okija	Library & Information Science
17.	Nnamdi Azikwe University, Awka	Library & Information Science
18.	Tai Solarin University of Education, Ijebu Ode	Library & Information Science
19.	Umaru Musa Yar'adua University, Katsina	Library & Information Science
20.	University of Calabar, Calabar	Library & Information Science
21.	University of Ibadan, Ibadan	Library & Information Science
22.	University of Ilorin, Ilorin	Library Science
23.	University of Maiduguri, Maiduguri	Library Science
24.	University of Nigeria, Nsukka	Library & Information Science
25.	University of Uyo, Uyo	Library & Information Science

Table 1: List of Approved/Accredited Nigerian Universities offering Library and Information Science Programmes

Source: <http://www.lrcn.gov.ng>

Despite the fact that 25 universities have been approved to offer LIS programme Alhassan and Ahmed (2015) observed that some of the approved library schools (e.g Ibrahim Badamasi Babangida University, Lapai) are yet to commence the programme.

Establishment of more library schools

During the 20th century, most library schools otherwise known as LIS departments were established in conventional universities. The creation of more parastatals, agencies like (National Agency for Food, Drug Administration and Control, National Institute for Oceanography and Marine Research) as well as establishment of more institutions of higher learning has necessitated the need to recruit more trained LIS professionals to discharge the optimal duties in various information related organizations. Furthermore, with the present realities of information as essential ingredient in any given society more library schools were established especially in the specialized universities such as Universities of Agriculture, Technology, Education and Distance Learning Programme. The table below contains the list of Nigerian specialised universities offering LIS programmes.

S/N	Name of Library School	Year Established
1.	Federal University of Technology, Minna	2001
2.	Abubakar Tafawa Balewa University, Bauchi	2005
3.	Modibbo Adama University of Technology, Yola	2008
4.	Tai Solarin University of Education, Ijebu-Ode	N/A
5.	Michael Opara University of Agriculture, Omudike	2012
6.	Federal University of Agriculture, Makurdi	2014
7.	National Open University of Nigeria (NOUN), Lagos	2014

Table 2: Specialised Universities offering LIS Programme in Nigeria

This shows that library school being a service institution can be located in any type of university and in any faculty or school. This is because information as an important resource is needed by everybody regardless of the field of study.

Continuous Professional Development (CPD)

The CPD refers to ways by which LIS educators/practitioners develop themselves which may not be far from various forms of training after the possession of professional qualification of Bachelor degree in librarianship. It is a lifelong learning process by which LIS educators and practitioners in library schools and libraries acquire skills that will enable them function effectively. The only way or avenue by which LIS educators can adequately acquire skills include but not limited to: conferences, workshops and seminar attendance, on- the- job training, mentoring and formal education (Saka, Song and Oyedum, 2014). The Nigerian Library Association, being the umbrella association to LIS profession has other sections, amongst which that of LIS education fall within. It is known as “National Association of Library and Information Science Educators (NALISE)”. The professional body is charged with the responsibility of organizing timely training programme for LIS educators. Thus, in the 20th and 21st century i.e between 1984 and 2015, 16 National conferences were held at various university-based library schools within Nigeria. Since the beginning of the 21st century i.e. 2001 to date, various conference themes were on the contemporary issues (training, standards, knowledge management, and entrepreneurship) of the 21st century of LIS education. The LIS educators meet at various conferences to present papers, discuss issues affecting LIS education in Nigeria. The table below contains various conference years, venues and dates as well as themes:

Trends in Library and Information Science Education in Nigeria in the 21st Century

S/N	year	Venue and Date	Theme
1	1984	Bayero University, Kano April 14-17, 1984	Education for Librarianship in Nigeria (State of the Art)
2	1985	Ahmadu Bello University, Zaria April 6-8, 1985	Towards Relevance In Library Education in Nigeria
3	1986	Imo State University, Owerri May 4-7, 1986	Professional Library Education: Levels and Job Utilization
4	1988	University of Ibadan Feb. 1988	Impact of Information Technology on Education and Training for Information
5	1990	University of Maiduguri Feb. 18-21, 1990	Library Education in Nigeria and Resource Crisis
6	1992	University of Nigeria, Nsukka Feb. 10-12, 1992	Library and Information Education for National Information Management in the 21 st Century
7	1994	Bayero University, Kano June 29-July 1, 1994	Library Education in Nigeria: The Way Forward
8	1997	Ahmadu Bello University, Zaria July 16, 1997	Redefining the Information Profession
9	1999	University of Ibadan, Ibadan Aug. 4-7, 1999	Information Technology in Education of LIS Personnel in Nigeria
10*	2001	Abia State University, Uturu Sep. 26-28, 2001	The Future of LIS Education and Training in Nigeria: Early 21 st Century Concerns
11*	2002	Delta State University, Abraka Nov. 19-21, 2002	Modernization of LIS programmes in Nigerian Universities
12*	2007	Imo State University, Owerri Aug. 28-31, 2007	Standards for LIS Programmes in Nigerian Universities
13*	2009	University of Nigeria, Nsukka June 2-4, 2009	Repositioning LIS Education for Knowledge Societies
14*	2011	Ahmadu Bello University, Zaria Nov. 8-12, 2011	Entrepreneurship Education in LIS Programme
15*	2014	Abia State University, Uturu April 28-May 1, 2014	Contemporary Issues in the Sustainability of LIS Education in a Globalized World: The Nigerian Experience
16*	2015	University of Uyo, Akwa Ibom State May 11-15, 2015	Training the LIS Students for Entrepreneurship in the 21 st Century

Table 3: NALISE Conferences (1984-2015)

Source(s): S/N 1-15: Dike, V.W (2014)

S/N 16: National Conference of NALISE 2015

Challenges to LIS Education in Nigeria

Despite the remarkable developments in LIS education in Nigeria, one cannot completely say that there are no problems. Based on literature search and correspondence with LIS colleagues, certain problems were identified. They include but not limited to: divergent curriculum, location and nomenclature of library schools and degree awarded, Indifferences of LIS Educators, proliferation of LIS programmes, staffing situation, low level of skills due to inadequate facilities and infrastructure

Divergent Curriculum

Most library schools have met the NUC Benchmark Minimum Academic Standard (BMAS) and as such are at liberty to add, restructure or modify the curriculum. In doing so, different library schools try to incorporate courses they feel necessary (Alhassan and Ahmed, 2015). This leads to variations, disparity in the courses taught among library schools. Studies conducted by Saka and Ahmed (2015) and Saka and Aliyu (2015) respectively revealed that library schools in Nigeria run divergent curriculum which according to Kalu and Obasi (2014) was due to differences in philosophy, vision and objectives, course contents, etc. (Kalu and Obasi, 2014). The implication is that while undergraduates in some library schools may be at advantage of having in-depth knowledge of some courses, undergraduates in other library schools will be at disadvantage taking into consideration the availability of facilities, mode of instruction, course content and use of instructional facilities in teaching. Find below ICT courses offered in the selected library schools in Nigerian universities in Tables 4A and 4B

Trends in Library and Information Science Education in Nigeria in the 21st Century

ESUTECH, Enugu	ATBU Bauchi	Fed. Univ. of Tech., Minna	MAUTECH, Yola
LIS 315: Multimedia process, equip. & material prod. LIS 403: MIS LIS: 404 Inf. Com. In Lib & Info centers LIS 409: Data base Design &Mgt LIS 416: Inf Networks	LIS 113: Digital Libraries LIS 115: Lib. Appl. Pack. CIS 142: Intro Computers LIS 222: MIS/ services LIS 327: Software Tech LIS 522: Data base design & Mgt.	CPT 111: Intro. to Computer Operation CPT 221: Info. Programming CPT 211: Object-Oriented Programming I LIT 213: Intro. to Computer Systems LIT 222: Inf. Technology & Society LIT 318: Data Communications & Networks CPT 313: Operating System I CPT 221: Object-Oriented Programming II LIT 312: Inf. Technology & Libraries CPT 316: System Analysis & Design CPT 325: Database Design &Mgt CPT 413: Systems Operation Research CPT 416: Software Engineering & Computer Ethics LIT 513: Inf. & Retrieval Systems LIT 514: Implication of Inf. Technology CPT 514: Advanced Database Systems LIT 522: Lib. Automation & Digitalization LIT 525: Electronic Publishing Source: Dept of LIT, student handbook, Minna (2014)	CS 101: Intro. to Computer Science I TT 101: Intro. to Inf. Technology CS 102: Intro. to Computer Science II TT 106: Digital Technology CS 201: Computer Programming I LS 204: Intro. to Telecommunication CS 202: Computer Programming LS 303: Inf. &Comm Technology CS 303: Operating System I CS 311: System Analysis & Management TT 304: Data Communication & Networking Application LS 401: Data processing in Lib. & Inf. Centres LS 411: Computer in Inf. Work TT 403: Computer Security LS 501: Automation in Library& Info. Centres TT 505: Web Publishing & Programming CS 510: Computer in Society TT 512: Telecommunication Source: Dept of LIS, students handbook MAUTECH, Yola
UNN LIS252: Comp & Data Processing LIS402: Contemp. Tech. in Libs LIS444: Int. Lib. Coop & Info Network	ABSU, Uturu IFS104: Basic Comp. Opera I IFS105: Basic Comp. Opera II IFS243: Inf. Tech in Lib &Inf Centres I IFS271: Inf. Sys. & Structure I IFS244: Inf. Technologies in Lib & info Centre II IFS246: Compt. Programming IFS 272: Information System & Structure II IFS411: Automation in Lib & Info Centres IFS466: Practical Computer Application IFS484: Advanced Info. Storage & Retrieval	IMSU Lib. Automation New Technologies	
UNI MAIDUGURI LIS 103: Intro to Computers LIS411: Inter. Lib. & Info Network LIS416: Digital Info. System			
UNI UYO LIS226: Comp. & Data Processing GST311: Applic.to Comp LIS314: Info Technologies LIS423: Info Retrieval from the Internet			
ABU, ZARIA LIBS211: Introduction to telecommunication LIS217: Computer in Information LIBS216: Introduction to Computer Operating System LIBS303: ICT LIBS320: Introduction to Application Package LIBS402: Intro. To Digital Info System & Services	MOUAU Intro to comp &comm. IT tools & comp applies Electronic/ digital libs Inf. Literacy Automation in Libs Website Devt & Internet Techs Database Mgt. Inforpreneurship		

Table 4A: List of Undergraduate ICT Courses in selected Nigerian universities offering LIS programme

Source to MOUAU, ABSU, IMSU= Ononogbo, R.U (2014)

Source: Library Schools' Undergraduate Handbooks 2010-2014

In some library schools as indicated above (ESUTEch Enugu, A.T.B.U Bauchi, U.N.N, University of Maiduguri, University of Uyo and I.M.S.U) not only run divergent ICT curriculum but the ICT courses are very few. Even though those of F.U.T Minna and MAUTECH, Yola are many, there is disparity in the courses/course contents. Generally the course codes are not uniform. Some are Library and Information Science (LIS), Information Science (IFS), Computer and Information Science (CIS) while others are Library and Information Technology (LIT), Telecommunication Technology (TT), Library Science (LS), etc.

S/N	Library Schools	No. of ICT Courses
1	Ahmadu Bello University, Zaria	6
2	Abia State University, Uturu	5
3	Moddibo Adama University of Technology (MAUTECH)Yola	18
4	University of Uyo, Uyo	4
5	Federal University of Technology, Minna	17
6	University of Maiduguri	3
7	Abubakar Tafawa Balewa University, Bauchi	6
8	Enugu State University of Science and Technology, Enugu	5
9	Michael Okpara University of Agriculture, Umudike	8
10	Imo State University, Owerri	2
11	University of Illorin, Illorin	9

Table 4B: Number of ICT courses offered in Selected Nigerian Library Schools

Source: Correspondence with Colleagues, 2015

Location of LIS Departments and Nomenclature of Degrees Awarded

There has been crisis in the location of library schools/departments of Library and Information Science under faculties or schools. University of Ibadan, Ahmadu Bello University, Zaria, University of Nigeria Nsukka, Bayero University, Kano, Universities of Maiduguri, Calabar and Uyo as well as Nnamdi Azikiwe Awka, Benue State University Makurdi, Umar Musa Yar'adua University Katsina, Federal University of Technology Minna, Abubakar Tafawa Balewa University, Bauchi were located under Faculty of Education/ School of Science and Technology Education respectively. Abia State University, Uturu is located under Faculty of Social Science.

In the same vein, the LIS department in University of Ilorin is located under faculty of Information and Communication Sciences; Modibbo Adama University of Technology Yola is located under School of Information and Management Technology. Whichever faculty or school the library school(s) is/are located, there is focus. Thus our major concern is that the curriculum should be rich, uniform and have focus just as being proposed by the LRCN.

As regards nomenclature of degrees awarded, library schools in University of Nigeria Nsukka and Bayero University award B.A/LS or B.Sc/LS respectively. Those of University of Ibadan, Ahmadu Bello University Zaria, University of Maiduguri, etc. award Bachelor of Library and Information Science (B.LIS) degree. Other library schools award B.Ed (Library Science). The BA/BSc/LS signify that certain number of art, social or physical science courses in addition to the major LIS courses need to be offered by undergraduates before graduation. The same thing happens to those pursuing B. Ed (Library Science), B. Tech (Library and Information Technology). Specifically, university of Maiduguri award Bachelor of Library and Information Science, Abubakar Tafawa Balewa University, Bauchi and Moddibo Adama University of Technology, Yola award B.Tech (LIS) (Madu, Odenigbo and Isah, 2014). Library schools in Nigeria operates different departmental names such as Department of Library Science; Library

and Information Technology while they are located in different faculties and schools such as Faculty of Education, Social Science, Computer Science/Technology, etc. The nomenclature of first degrees awarded include BLS/Botany, B.Ed (Library Science or BLS (Ed) (Okeke and Oghentaga, 2014). However, the issue of location of library schools should not be problem rather the curriculum` must be uniform, have focus and be rich in content. Thus, library schools should be free to be located in any faculty, school or create their own faculty or school e.g School/Faculty of Library and Information Science. Find below selected library schools with their location/faculties/schools and nomenclature of first degree awarded in Nigerian Universities.

S/N	Library Schools	Location Faculty & School	First Degrees Awarded
1	University of Ibadan, Ibadan	Education	BLIS
2	Ahmadu Bello University, Zaria	Education	BLIS
3	Bayero University, Kano	Education	BA/BSc
4	University of Maiduguri, Maiduguri	Education	BLIS
5	University of Nigeria, Nsukka	Education	BA/BSc
6	Imo State University, Owerri	Social Science	BA/BSc
7	Abia State University, Uturu	Social Science	BSC
8	Ambrose Alli University, Ekpoma	Social Science	BLS
9	Enugu State University of Science & Technology, Enugu	Education	BLS(Ed)
10	Nnamdi Azikwe University, Awka	Social Science	BLIS
11	Madonna University, Okija	Social Science	BLS
12	Delta State University, Abraka	Education	BLS
13	Federal University of Technology, Minna	Science & Technology Education	B.Tech (LIT)
14	Modibbo Adama University of Technology, Yola	Info & Mgt. Technology	B.Tech LIS
15	Abubakar Tafawa Balewa University, Bauchi	Technology Education	B.Tech LIS
16	University of Ilorin, Ilorin	Communication and Information Sciences	B.Sc LIS

Table 5: Location of Library Schools and Nomenclature of first degrees awarded

Source: S/N 1 – 13 Okeke, I.F & Oghetega L.U 2014.

S/N 14 – Departmental Student Handbook

S/N 15 – Contemporary Issues NALISE Conference Proceedings (2014)

S/N 16 Saka, K.A &Garba, S. K. (2014) Directory of Academic & Research Librarians in North Central, Nigeria.

Proliferation of LIS Programmes

The establishment of more library schools in specialized universities is a welcome development. However, the rate at which LIS programmes are springing up does not give room for provision of quality resources (curriculum, physical resources and LIS educators) to enhance quality teaching, learning and research. More library schools were established without due regards to standards in terms of curriculum, human and material/physical resources (Ochogwu and Nwokocha, 2014).

Indifference of LIS Educators towards Continuous Professional Development (CPD)

With about 30 library schools in Nigerian Universities and almost 25 in polytechnics/monotechnics and colleges of education, it is disheartening that very few LIS

educators do attend annual conference(s) and workshops. As LIS educators, it is expected that they should be at the fore front in search for knowledge or update their knowledge so that they can in turn impact skills to students. Find below the number of NALISE conference attendees between 2009 and 2015

S/N	Year	Venue	No. of Attendants
1	2009	University of Nigeria Nsukka	42
2	2011	Ahamdu Bello University, Zaria	50
3	2014	Abia State University, Uturu	39
4	2015	University of Uyo, Uyo	37
		Total	168

Table 6: NALISE Conference Attendants/Delegates

Source: Correspondence with colleagues, 2015

Assuming that in each library school the staff strength assessed at 10 on a scale of 55, stood, it is expected that we have 550 LIS Educators all over the country and at least 10% of 550 should attend NALISE conference yearly, although a part of the factors responsible for the indifference might be related to the fact that some parent institutions are not willing to sponsor their staff so the latter can attend to conferences and workshops.

Low level of skills due to inadequate facilities

There are no adequate facilities provided, and, as such, the acquisition of ICT skills is low at undergraduate levels. This is because of the inadequate computer laboratories, which has led to low level of ICT skills/practices. It is paramount to note that the traditional mode of teaching in our library schools today cannot withstand the modern trends as computers and other ICT facilities are needed in training the prospective LIS graduates. Regrettably, the number of computers in the ICT laboratories in Nigerian library schools cannot cater for the teeming population of students. A study conducted by Saka (2009) revealed that 74 computers were available in five university-based library schools in Northern Nigeria and are expected to be used by 1,740 undergraduate students. In a related study, Saka and Ahmed (2014) found out that the practicals offered in Nigeria library schools are not adequate enough for undergraduates to function independently.

Staffing Situation

Most library schools face the problem of staffing especially at the professorial cadre. As a result of this, library schools are compelled to look for visiting/part-time lecturers. The situation could partly be attributed to the turnover of LIS educators for greener pastures. With the establishment of new universities in Nigeria, some LIS Educators have moved or transferred their services to the new universities; thus, the library schools suffer acute shortage of lecturers (Ononogbo, 2014) and as such rely heavily on part-time lecturers (Saka & Abdullahi, 2007). This has led to overloading the few available faculty members with many courses to teach.

Conclusion

Library education commenced in Nigeria with the establishment of a library school at the Institute of Librarianship, Ibadan in 1959. Between the 60s and 90s, library schools have increased in number and in the 2000's, the increase in the number of library schools was not limited to conventional universities but also to specialized ones. The same situation exists with polytechnics, monotechnics and colleges of education. The 21st century is characterised by remarkable developments and challenges to LIS Education in Nigeria. However, the implication

is that stakeholders in LIS education should come together to discuss ways that would enhance training in LIS education as done in other parts of the world.

Recommendations

Based on the positive and negative trends in LIS education in Nigeria in the 21st century, the paper proffers practical recommendations on the following areas:

The Improvement and Adoption of the “Developed Uniform Curriculum” (NUC and LRCN)

In order to have uniform curriculum for LIS education, the NUC and LRCN (parastatals under Federal Ministry of Education) must work hand in hand so as to improve and adopt the already developed uniform curriculum. This is because LRCN is the professional body responsible for (among other things) maintaining standards for acquiring knowledge as librarians while NUC is a parastatal under Federal Ministry of Education that is charged with the responsibility of supervising academic activities in all universities in Nigeria.

A Uniform location and the Nomenclature of the Degree Awarded

Although library schools can be located in any faculty or school or even have a faculty of its own, it would be better off if library schools in Nigeria are located under one faculty/school and have uniform nomenclature of either BLIS or B.Sc.

The Recruitment of LIS Educators

LIS professionals at the professional cadre should be attracted towards employment in Nigerian library schools, with better conditions of service and improved fringe benefits. If they are well-motivated, the issue of turn-over of staff in search of greener pasture or brain-drain could be reduced.

LIS Educators’ Attitudinal change towards CPD

There should be a positive change in attitude of LIS Educators in terms of conferences/workshops attendance. They should look for means of improving themselves and not to completely rely on parent institutions for sponsorship. The parent institutions should however, sponsor a reasonable number of LIS educators to conferences and workshops (e.g. NALISE) on annual basis.

The Accreditation of New LIS Programmes

The National Universities Commission (NUC) and the Librarians’ Registration Council (LRCN) should ensure that as library school(s) is/are established, they should be made to undergo accreditation exercises to determine standards in terms of curriculum, physical resources and LIS educators and admission requirements.

Adequate facilities/Infrastructure

The existing ICT laboratories in all Nigerian library schools should be well equipped, while the library schools without laboratories should be encouraged to establish one. Adequate laboratories would enhance the provision of adequate and efficient practicals and the acquisition of IT skills. Above all, the parent institutions (universities, polytechnics, monotronics and colleges of education) running LIS programme should provide adequate funding for the procurement of facilities in the ICT laboratories. This will further facilitate not only the establishment of demonstration/workshops for cataloguing and classification, but the workshop/demonstration should be put in place for practical class in cataloguing and classification as well as keeping/storing these vital tools there.

References

- Abia State University, Uturu (2010). Library and information science handbook for undergraduates
- Ahmadu Bello University Zaria (2014-2017). Department of library and information science undergraduate student's handbook.
- Aina, L.O. (2013). *Information, knowledge and the gatekeeper*. The 132nd Inaugural lecture. University of Ilorin, Ilorin Press.
- Akanwa, P.C. (2014). Incorporating new ICT courses in the curricula of Library and Information Science (LIS) programme in Nigeria. In *Proceedings of the 16th National Conference of NALISE. April 28-May 1, 2014, Abia State University, Uturu*, 128-139.
- Alhassan, J.A.& Ahmed, A.O. (2015). Emerging technologies and the future of libraries: Issues and challenges in LIS education and training in Nigeria. In *proceedings of 3rd international conference of the school of science and technology education (SSTE) Held at CPES Hall, Bosso Campus, FUT Minna, 4-7th October, 2015* 152-157.
- Dike, V.W. (2014) Sustainability of LIS education in a globalised world: Contemporary issues. Keynote Address Presented at the 15th National Conference of the NALISE held at Abia State University, Uturu from April 28-May 1, 2014, 1-13
- Eyo, E.B.E; E.J. & Akin-Fakorede, O. (2014). Training the trainer: Emergency trend in the course content of LIS education in South, Nigeria. *Paper Presented at NALISE Conference held at Abia State University, Uturu, Nigeria on April 28-May 1st 2014*
- Federal Republic of Nigeria (2005). Librarian (Registration, ETC) Council of Nigeria Decree 12, 1995
- Federal University of Technology, Minna (2014): Department of library and information technology (B.Tech) library and information technology degree programme). Handbook for undergraduate students.
- Federal University of Technology, Minna (2015): *Extracts from of the major decision of the Senate from January 2013 – December, 2014*, 44.
- Federal University of Technology, Yola (nd): Department of library and information science. undergraduate programme brochure
- Issa, A.O., Amusan, B.B., Aliyu, M.B. & Ladan, A (2014). Library and information science education in Nigeria and its implications for standard training in a globalized era. In *proceedings of national conference of NALISE held at Abia State University, Uturu, April 28-May 1*, 82-99
- Ibid in Fitzgibbons, S. (2003). Association for LIS education. In *encyclopaedia of LIS*, 2nded, edited by M.A. Drake
- Ibid in Microsoft Encarta (2009). *Library (Institution)*, Redmond, WA: Microsoft cooperation
- Ibid in Wilson, T.D. (2001). Mapping the curriculum in information studies. *New library world*, 102(11), 436-442
- Kalu, A.U. & Obasi, N.F.K. (2014). The crisis and nomenclature and location of library and information science education in Nigeria: a discourse. In *proceeding of the 16th national conference of national association of library and information science educators (NALISE), April 28-May 1, 2014, Abia State University, Uturu*, 69-81
- List of approved/accredited Nigerian universities offering library and information science programmes. available online at www.lrcn.gov.ng
- List of certified librarians in Nigeria (2013). Librarians' Registration Council of Nigeria (LRCN). Abuja: Federal Ministry of Education.

- Madu, U.A., Odemigbo, P.&Isah, R.L. (2014). Comparative analysis of LIS undergraduate curriculum and education in north east region, Nigeria. *In proceedings of 16 National Conference of the National Association of Library and Information Science Educators held at Abia State University, Uturu, April 28-May, 1, 2014*
- National Universities Commission, Nigeria (2014). *Benchmark minimum academic standards for undergraduate programmes in Nigeria: library and information science.*
- Nwokocha, U., Onwubiko, C.P.C. &Unagha, A.O. (2014). Trends, challenges and future of library and information science education in Nigeria. *In proceedings of national association of library and information science educators (NALISE). April 28-May 1, 2014, Abia State University, Uturu, 163-181*
- Ochogwu, M.G. &Nwokocha, U. (2014). Communiqué issued at the end of the 16th NALISE conference held at Abia state university, Uturu, April 28- May 1st 2014.
- Okeke, IF &Oghentaga, L.U (2104). *Crisis of nomenclature and location in Nigeria university based library schools: The way forward.* Paper presented at the national conference of NALISE held at Abia State University, Oturu, April 28 – Ma 1, 2014
- Ononogbo, R.U. (2014). Contemporary issues in library and information science education: The Nigerian experience and sustainability thereof. *In Proceedings of 16th national conference of the national association of library and information science educators held at Abia state university, Uturu, April 28-May 1, 14-26*
- Reitz, J.M. (2005). *Dictionary for library and information science.* Indian ed. Westport: libraries unlimited.
- Saka, K.A. (2009). Extent of the implementation of undergraduate ICT in library's curriculum in northern Nigeria. *Global review of library and information science, 5, 51-61*
- Saka, K.A. &Abdullahi, A.M. (2007). Library and information science education in Nigeria: problems and prospects. *Borno library, archival and information science journal. 5(1), 39-44*
- Saka, K.A &Garba, S.K (2014) *Directory of academic and research librarians in north central Nigeria.* Zaria: Ahmedu Bello university press limited
- Ibid in Olden, C.A. (1980). *The development of the department of library science, A.B.U. and its implication for the planning of library education programme in English-speaking black African countries.* (Unpublished MLS thesis), Ahmadu Bello university, Zaria.
- Saka, K.A. & Ahmed, A.O. (2014). Entrepreneurial librarianship for self-employment opportunities in Nigeria. *In proceedings of the 16 national conference of the NALISE held at ABSU Uturu from April 28-May 1, 2014*
- Saka, K.A. & Ahmed, A.O. (2015). Training the undergraduates in entrepreneurial ICT in Nigerian library schools. *In proceedings of 17th national conference of the NALISE, held at university of Uyo, Uyo, Akwa-Ibom state, May 11-15, 2015.*
- Saka, K.A.; Song, I.S. &Oyedun, G.U. (2014). Influence of continuing professional development and skills acquisition on librarians' performance in two state capitals in northern Nigeria. *In proceedings of annual conference of the nigerian library association Enugu state chapter, held at the national library of Nigeria, Enugu branch from 25-29th November, 2014.*
- Salau, A (2015, July, 22) council develops new library curriculum for schools. *Daily trust, Abuja, p.14*

University of Ibadan, Ibadan Nigeria. Faculty of education undergraduate and postgraduate prospectus 2011/2012-2012/2013 sessions.

University of Maiduguri, Maiduguri (2011). Department of library and information science handbook for BLIS degree programme, courses and regulations (reversed edition)

University of Maiduguri, Maiduguri (nd), postgraduate prospectus (unpublished).

University of Nigeria, Nsukka (2010-2014): Department of library and information science students handbook.

Sentiment Analysis and Education

Sandeep Sricharan Mukku¹, Nurendra Choudhary² and Radhika Mamidi³

1 IIIT Hyderabad, Language Technologies Research Centre, India

2 IIIT Hyderabad, Language Technologies Research Centre, India

3 IIIT Hyderabad, Language Technologies Research Centre, India

Abstract

This paper describes the detailed approach on how to classify and analyze the polarity or opinion (e.g. positive, negative, or neutral) of a given document, text-span or sentence. The experiments with various methods showed that the best performance can be achieved with the combination of both baseline and feature-based model. In addition, we have shown the potential application of this work in diverse fields.

Keywords: Sentiment Analysis, Education, Opinion Mining

Introduction

The sentiment is the attitude, opinion or feeling toward something, such as a person, product, organization or location. Sentiment analysis is a tool to identify and extract subjective information the given source. Sentiment analysis task, also known as opinion mining often use natural language processing, text analysis and computational linguistics. One will like to know others opinions about movies, books, products, etc. These opinions and reviews can be found in social networking sites, personal web-blogs, discussion forums and so on. These opinions can also be used by companies to improve their product sales and services.

Problem Statement

The problem of sentiment analysis is classifying the polarity of a given text at the sentence, document or feature or aspect level. Whether the expressed opinion in a document, a sentence or an entity feature/aspect is objective (also known as neutral) or subjective (also known as positive or negative).

Motivation

With the proliferation of web 2.0, a user-generated online content or increase in popularity of online review websites and personal blogs, it is difficult for a user to crawl through all the data. Therefore, sentiment analysis is a tool capable of extracting the information most important to the user from the plain text data. This led to an increase in research in areas of opinion mining and sentiment analysis, with the thought of producing methodologies that can automatically analyze text spans or user reviews and extract information most relevant to the user. As a result, we thought of narrowing this tool for the field of education.

Related work

Even though the area of opinion mining has recently emerged as a new research topic, a considerable amount of research activity has been done. We will discuss some of the related works that motivated and helped us throughout this work will be explained in this section.

In (Pang, & Lee, 2008) gave the strong emphasis on why this area of the opinion mining and sentiment analysis is much of a research problem. This paper also discusses some of the general challenges such as contrast with standard fact-based textual analysis. It also lists of some of the factors that make opinion mining difficult. This helped us to work on this problem of sentiment analysis.

In (Wilson, et al., 2005) the authors tells how to detect contextual polarity in phrase-level. The authors gave a decent approach to extract sentiment at phrase-level or sentence-level. Moreover, this work stresses on contextual polarity. It says that contextual polarity of the phrase may be different from word's prior polarity. This work also describes the intensity of negation and its effect on the polarity of the phrase. So we conducted our experiments at phrase-level also.

In (Pak, & Paroubek, 2010) the work is mainly on microblogging site such as twitter, taking the tweets data as the corpus of the work. This paper presents a method on how to collect a corpus of both positive and negative sentiments and also objective texts with no human effort. They performed statistical linguistic analysis of collected corpus. This paper motivated us to think of different possibilities of collecting corpus.

In (Godbole, & Srinivasaiah, 2007) says how to perform large-scale sentiment analysis for news and blogs.

In (Kouloumpis, et al., 2011) this paper is presented with data preprocessing. We have adopted this approach of data preprocessing into our work.

Methodology

In this section we have used different machine learning methods, viz.,
 Baseline method,
 Naive Bayes (NB) and
 Maximum Entropy (MaxEnt).

We first take the text-span and then tokenize it in the tokenization step. We take the tokens and then pre-process the tokens, which removes punctuations etc. Then we detect the features and extract them. These features are predicted the polarity with the help of the various methods mentioned above.

Baseline

This model makes use of “bag of words” which relays more on the words, or sometimes a string of words. This model usually has a large list, it would be better if we consider it as a dictionary which is considered to be words that carry sentiment, i.e., a list of positive and negative words. For each text-span, we consider the number of positive and negative keywords that appear. This classifier returns the polarity with a higher count. In the case of a tie, the polarity of the majority class is returned.

Naive Bayes (NB)

Naive Bayes is a simple model which works effectively on text categorization. We used a multinomial Naive Bayes model. Here class c^* is assigned to a text-span d , where

$$c^* = \underset{c \in C}{\text{argmax}} \left(\frac{N(c, d)}{N(d)} \right)$$

$$P(c | d) := \frac{(N(c, d) + 1) \prod_{i=1}^n P(w_i | c)}{\prod_{i=1}^n (N(c) + 1) P(w_i | c)}$$

Maximum Entropy (MaxEnt)

Maximum entropy classifiers are commonly used as substitutes to Naive Bayes classifiers as they do not assume statistical independence of random variables that serve as predictors. Random variables are usually known as features. However, learning in such a model is generally slower than for a Naive Bayes classifier, and thus may not be applicable given a very large number of classes or features to learn. Learning in Naive Bayes classifier is a fundamental way of counting the number of co-occurrences (combined occurrences) of features and classes, while in a MaxEnt classifier the weights, which are typically maximized using maximum a posteriori (MAP) estimation, must be learned using an iterative procedure.

Approach

The approach and work-flow is shown in the following figure.

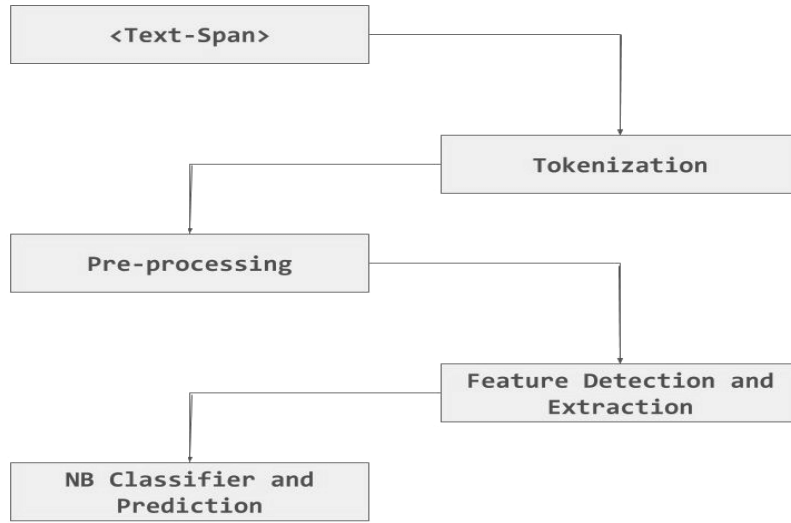

Figure 1: Work-flow of implementation of the methodology used

Results

The results were obtained with baseline model on taking the unigrams, bigrams and trigrams and contrast it with the feature based model for two subtasks, i.e., document-level and sentence-level. Following are accuracy and F1 score with the corresponding subtasks at different levels.

Accuracy

The corresponding table shows results of accuracy at two different levels for various approaches out of which the combination of first two approaches gives the better results of accuracy at both the levels.

Subtask	Baseline Model	Feature-based Model	Baseline + Feature-based Model
Document-Level	65.32%	78.93%	80.49%
Sentence-Level	54.76%	59.84%	61.27%

F1 score

The corresponding table shows results of the F1 score at two different levels for various approaches out of which the combination of first two approaches gives the better results of the F1 score at both the levels.

Subtask	Baseline Model	Feature-based Model	Baseline + Feature-based Model
Document-Level	78.53	77.29	77.81
Sentence-Level	58.67	61.08	63.42

Potential Applications

Feedback during the semester

The course feedback from students at the end of the semester was taken; however, this has the drawback of not being helpful for students who have already taken the course (after completion of the course). Feedback should be taken in real time and analyzed in real time to assist and help the current students. This would allow students and teachers to address teaching and learning issues in the most favorable way for students.

The analysis of feedback using sentiment analysis approach can identify students' positive or negative feelings or even more refined emotions that the students are feeling to the present way or style of teaching. Feedback and comments can be collected in many ways using student response systems such as remote controls, mobile phones and sms. Responses can be gathered or acquired via social media such as twitter. In this way, using sentiment analysis on educational data can help in enhancing the teaching methodology. Opinions can be positive or negative. Different emotions can also be equated with these opinions. Moreover, emotions can be as bored, confusing and irritated. Responses such as confidece and enthusiasim might be considered as positive emotions. When a student feedback does not reflect either positive or negative feedback we may consider it as neutral feedback.

MOOC Discussion Forums

MOOC Discussion forums can use collective sentiment analysis to study students' attitudes towards the course and course tools based on forum posts (course-level sentiment analysis). Use survival analysis (time up to which a student is interested) and later the active participation may decrease, sometimes lead to drop out of the course.

Book Reviews

Reviews from different book-selling sites will be collected and analyzed with our tool sentiment analysis. Analysis based on author, content and genre will be collected. The author may be renowned, but the book he published may not be up to the mark. These all can be analyzed using our tool. This helps the buyers come to a conclusion and wish to buy or not. This also helps authors to analyze where he went wrong and rectify his mistake in his/her book. She/he will also get to know the taste or the essence of the readers. Book publishers also now see how and what exactly the readers looking for and then choose whether to publish or not for his next publication(s).

Conclusion

This paper presented a family of Naive Bayes classifiers for the prediction of polarity. The experiments have shown that the best performance is achieved by using the binary classifier, trained to detect just two categories: Positive and Negative. In order to detect polarity, this work needs a strategy based on searching for polarity elements within the text span.

Future Work

We would like to extend this work to different domains and finally make it domain independent. We would also like to work on more fine-grained aspects and make a tool for aspect-based sentiment analysis.

References

- Godbole, N., Srinivasaiah, M., & Skiena, S. (2007). Large-Scale Sentiment Analysis for News and Blogs. *ICWSM*, 7(21), 219-222.
- Kouloumpis, E., Wilson, T., & Moore, J. D. (2011). Twitter sentiment analysis: The good the bad and the omg! *ICWSM*, 11, 538-541.
- Liu, B. (2012). Sentiment analysis and opinion mining. *Synthesis lectures on human language technologies*, 5(1), 1-167.
- Liu, B. (2010). Sentiment Analysis and Subjectivity. *Handbook of natural language processing*, 2, 627-666.
- McCormack, C., & Jones, D. (1997). *Building a web-based education system*. John Wiley & Sons, Inc.
- Pak, A., & Paroubek, P. (2010, May). Twitter as a Corpus for Sentiment Analysis and Opinion Mining. In *LREc* (Vol. 10, pp. 1320-1326).
- Pang, B., & Lee, L. (2008). Opinion mining and sentiment analysis. *Foundations and trends in information retrieval*, 2(1-2), 1-135.
- Pang, B., & Lee, L. (2004, July). A sentimental education: Sentiment analysis using subjectivity summarization based on minimum cuts. In *Proceedings of the 42nd annual meeting on Association for Computational Linguistics* (p. 271). Association for Computational Linguistics.
- Wilson, T., Wiebe, J., & Hoffmann, P. (2005, October). Recognizing contextual polarity in phrase-level sentiment analysis. In *Proceedings of the conference on human language technology and empirical methods in natural language processing* (pp. 347-354). Association for Computational Linguistics.

The Application of Rhetorical Differences to EFL Reading and Writing Education

Lihua Wang¹ and Qinghua Wang²

¹ Kunming University of Science and Technology
Faculty of Foreign Languages and Cultures
Kunming, Yunnan, China
² Dali Bureau of Education
English Teaching and Research Section
Dali, Yunnan, China

Abstract

Most freshmen are usually unable to summarize the essays they have read because they have difficulties in finding the thesis statement of an English text and extracting its structure even if they have known all new words in it. Their English compositions usually seem out of focus. After analyzing their problems, it seems that the rhetorical patterns in Chinese exert a negative influence on their English learning. Therefore, some relevant methods are adopted to instruct them. Firstly, the typical differences in expression were illuminated between English and Chinese. Secondly, the students were asked to read and compare two groups of essays which are on same topics but written in English and Chinese. Thirdly, they were asked to recall how their high school teachers usually instructed them to write in Chinese; and then, they were required to reflect on the relationship between the instruction and Chinese rhetoric. Fourthly, the basic, typical structure of an English essay was introduced. Finally, they were asked to find the thesis statements and trace the outlines of some English texts from their textbooks. These methods have been adopted in three batches of freshmen and turned out to be helpful. After training, most of the freshmen could find the thesis statement and know the structure of each English text from their textbooks within a few minutes before an intensive study of them. Meanwhile, they gradually tried to organize their English compositions properly.

Keywords: University students, Rhetorical differences, EFL reading and writing education

Introduction

In many years, most of every batch of the freshmen in my classes have been found to have the same difficulties in English learning: 1) They usually can't find out the thesis statement nor tell the structure of an English text even if they have known all the new words and grammatical rules in it but they can answer most multiple choice questions correctly by finding out specific information; 2) most of them can't organize their English compositions properly when they use grammatical rules and words almost correctly. Their compositions usually seem out of focus.

Their difficulties should be common among college students in the main land of China. According to Ministry of Education of the People's Republic of China, there are 2845 universities and colleges in China in 2015. College students vary in the English level. My university is ranked in the first 100 of the total number in China based on the appraisal of Chinese universities and colleges in 2015 made by WU Shulian (武书连) who has been studying university appraisal 24 years in the main land of China. Although my university is located in the Southwest of China, my students come from every part of the mainland as well as Hainan Island. Furthermore, in order to organize class activities conveniently, the freshmen in my university are divided into two big groups in English learning—Group A and B—based on their scores in the English Test in National University Entrance Examination and the test they took after entering the university. The students who passed the tests are in Group A and their English level can meet the study requirements of college English in China. My students are in Group A. They could be a representative sample of many Chinese college students in English learning. Therefore, if they had such difficulties in English learning, a large number of college students would have the same problems.

By studying the results of their reading comprehension exercises and their compositions, I found that it seemed that their problems were beyond English. Perhaps, it was the rhetorical differences between English and Chinese that made their English learning difficult. There are two reasons. One is that, when learning an English text, they usually pay attention to the grammatical rules and vocabularies but not the way of how the author to organize their ideas. The other one is that they have an idea of how to read and write in Chinese, which will exert a negative impact on their English learning.

Literature Review

In 1966, in his paper—*Cultural Thought Patterns in Intercultural Education*, Robert B. Kaplan exposed some typical features of thought patterns as following and noticed the impact exerted on language teaching by them.

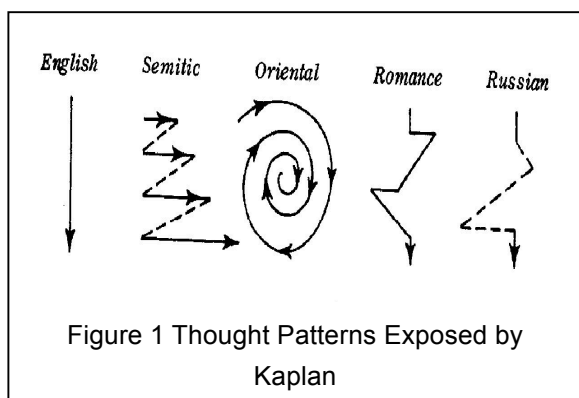

He proposed there should be difference in the teaching of reading and writing between American students and foreign students because of cultural differences in the nature of rhetoric. He said, “The teaching of reading and composition to foreign students does differ from the teaching of reading and composition to American students and cultural differences in the nature of rhetoric supply the

key to the difference in teaching approach.”(Kaplan, 2001)

Since then, more and more researchers have studied contrastive rhetoric. In TESOL 96 meetings in Chicago, quite a few researchers agree:

“1) A very broad range of studies have shown that no language or culture can be reduced to one or two diagrammatic structures which might be applied across the board from internal cognitive schema to paragraph structure, whether these might fly under the flags of ‘circular’, ‘direct’, ‘indirect’, ‘zig-zag’, ‘inductive’ or ‘deductive’; 2) At the same time, there is strong, clear evidence, amply demonstrated across the languages of the world that there are situationally, generically, or stylistically preferred compositional forms and that these are not the same from language to language or culturally defined situation to culturally defined situation.”(Scollon, Scollon & Kirkpatrick, 2000)

Maybe a language or a culture can't be reduced to one or two diagrammatic structures, but it is a fact that language is influenced by thought pattern. Due to intercultural communication, the rhetoric in one culture is often influenced by those in other cultures. However, it's a virtual certainty that people in different cultures prefer some rhetorical devices closely related to their cultures. Thus, people from different cultures may have some difficulties in understanding each others. Chinese people are often more indirect, more implicit than the people from English speaking world. Take the following examples. Chinese people usually don't say “I love you” to show their affection toward their family members except the young people when they fall into love. Chinese people often show their affections to each other by sharing some topics with interest and pleasure or do some interesting things happily together. Chinese people seldom say “Thank you” among family members. Instead, they will smile or show their happiness to express their appreciation.

The Influences on Chinese Expressions

Many factors exert influences on people's expressions, such as philosophy, society, the topic and their opinion on how to deal with interpersonal relationship, etc.

In China, Golden Mean was advocated in Confucianism and it has become a traditional philosophy more than 2,000 years. Whether we perceive it or not, it has an impact on us everywhere. Thus, achieving harmony is always what we want whatever situation we are in. Consequently, Chinese people are not too explicit. When talking, we like to talk around the topic but not state it in detail (点到为止), especially when talking about some embarrassing or unpleasant topics.

Meanwhile, hierarchical system lasted several thousand years in China so that hierarchical relationships have always been important in a political situation, working environment and at a family. How to remind or persuade authorities, superiors or elders smoothly requires delicate ways to speak or write. Furthermore, collectivism is what we emphasize. We prefer to give a group priority over an individual. In daily life, we like to stay within a group. If we want to work or stay together peacefully, we have to care about how others feel. Therefore, we promote harmony whatever we do and wherever we are. Owing to the impacts of these principles, we prefer delicate and indirect ways in expressions.

The differences in rhetoric between English and Chinese

In many cases, Chinese speakers or writers wish their listeners or readers could make sense of what they hear or read according to context although what they are listening to or reading is implicit. Of course, when organizing their ideas, the speakers or writers arranged them in some delicate ways by which their listeners or readers would be guided naturally and decently to the conclusion they wanted. Thereby, Chinese people seldom state their theses in the introduction of their essays. On the contrary, in most cases, a thesis statement will be presented in the introductory paragraph(s) explicitly in an English essay.

In contrast to the people who speak English, Chinese people usually adopt inductive reasoning although they are also good at deductive reasoning. Therefore, in Chinese, there is always a lot of background information put in front of foreground. Meanwhile, Chinese people always express themselves in a natural thought flow. Thereby, we prefer such natural sequences as action—result, cause—effect, a modifier before its modified and subordinate information before the main point. On the contrary, English is more flexible in the structures of sentences.

Furthermore, analogy is usually used more in Chinese. With the help of analogy, it's easy and natural for a speaker or a writer to guide their listeners or readers to what they really mean. Generally, making oblique references is a common way which Chinese people adopt in their conversations or writings especially when they want to give some suggestions or make a criticism.

Chinese is a more paratactic language than English in that it has less use of connectors (Scollon, et al., 2000). Although there are more connectors in modern Chinese than ancient Chinese with the influence of Western languages, the connectors in English are still more than these in Chinese. Take the following examples. In Chinese, there are only “Yinwei (因为)” or “Youyu (由于)” to show reason which can be used as a conjunction or preposition, while, in English, there are more connectors such as the conjunctions: “as”, “because”, “for”, “since”, “in that”, “in respect that”, etc, and the prepositional phrases: “because of”, “what with”, “on account of”, “owing to”, “due to”, “thanks to”, “as a result of”, “in virtue of” and so on. There are “however”, “nevertheless”, “while”, or “whereas” to mean “in contrast or comparison with the fact that” in English, but there are just “RanEr (然而)” or “Er (而)” in Chinese.

Every language just has their own basic characteristics in the structure of a text, which could be proved by the ways of how students are instructed to write in their mother tongues. Just as students are always taught basic and typical knowledge, so are they instructed in composition. There are differences in composition instruction between Chinese and English.

Chinese students are usually encouraged to organize their ideas in their compositions inventively. YUAN Mei (袁枚), a poet and a theorist of poetry in the Qing Dynasty of China, said that reading was like watching a mountain, no one wanted to look at a piece of flat land, and that there was nothing to enjoy if a piece of writing was as flat as a square field or stone. (文似看山不喜平, 若如井田方石, 有何可观). YUAN Mei tried to illuminate that writing should be variable in its structure, and that it would be boring if a piece of writing could be comprehended thoroughly at a glance. Chinese people always think that a good essay should show variety and should avoid writing in a simple and straight way. YE Shengtao (叶圣陶), a

modern famous Chinese writer and educator, also said that compositions shouldn't be constant while they are like streams which could be long or short, winding or straight and could run respectively to their own destinations in their natural ways (作文不该看作一件呆板的事情, 犹如泉流, 或长或短, 或曲或直, 自然各异其致)(Wang, 2013). The words show the basic instruction in composition in Chinese——there is no typical, basic compositional form for students to follow.

There is no uniform structure of a paragraph or an essay in modern Chinese for students to follow although there was an especially uniform writing style in ancient Chinese—Bagu Wen (stereotyped writing/eight-legged essay) which was used in the imperial examination system to select officials in the Ming Dynasty (1368-1664) and the Qing Dynasty (1636-1912). In modern Chinese, writers can state their main points at the opening, in the middle or the end of their essays although, in most cases, the central idea will be stated in the end of an essay. When teaching how to write a composition, some Chinese teachers will suggest their students echo the beginning (the introductory part) with the ending (the concluding part) of an essay (首尾呼应), present their thesis statements at the beginning of their compositions (开门见山—Open the door and see the mountain) or state the thesis in the conclusion of an essay (最后点题). In fact, if students can state the main idea inventively and naturally, their compositions will be acceptable. Students are encouraged to write the introductory part imaginatively. “How to open a composition, a riot of color (如何开头, 万紫千红——The ways to write an introductory part are rich in variety)” says MAI Jian (麦坚) (Mai, 2014), a Chinese experienced expert of composition, who has studied how to write compositions in Chinese more than ten years. Generally, what matters is ingenious in Chinese composition.

In contrast, the structure of a paragraph or an essay is more uniform in English. When teaching students how to organize a paragraph or a composition, English textbooks or teachers always supply a uniform structure. Take the following examples. According to Doug Emory, “a topic sentence is often, but not always, the first sentence in a paragraph”; the introductory paragraph of an essay serves two important functions. First, it draws readers into the essay; and second, it presents the thesis statement of the essay. “In the conclusion to an essay ... The writer summarizes or reinforces the central point and main ideas to leave readers with a memorable final thought or image.” (Emory, 1995) Santi V. Buscemi says, “Starting with a general statement and supporting it with specific details and ideas is one of the most popular and effective ways to organize a paragraph”. As to the introduction of an essay, Buscemi thinks that “in general, a formal introduction accomplishes the following: It reveals the essay's central idea as expressed in the thesis...” As to how to end an essay, Buscemi also gives seven suggestions, “Rephrase or make reference to your thesis; summarize or rephrase your main points; make a call to action; look to the future; explain how a problem was resolved; use a rhetorical question; and close with an anecdote” (Buscemi, 1990). Nancy Herzfeld-Pipkin gives the same suggestions, too. She says, “The first sentence often tells the reader the main idea of the paragraph”; “Introductory paragraphs usually begin with general information, become more specific in the middle, and end with a thesis statement.” As far as the concluding paragraph, Herzfeld-Pipkin suggests, “Summarize or briefly restate the main points of the essay; restate the thesis in order to emphasize the main idea; add some final comments in any of the following ways: make a prediction about the

future regarding your essay topic, give advice or make suggestions about the situation of topic or show results of the situation or topic” (Herzfeld-Pipkin, 2007).

Even when organizing a speech, one will do the same. Sue Kay, an English expert who teaches English speech in China more than 10 years, says that an English “speech must have a beginning, middle and an end. The beginning tells your listeners what you are going to speak about—and sometimes why. The end restates the main points of the content and if appropriate relates back to the introduction” (Kay, 2001).

It is clear that the typical structure of an English paragraph usually consists of a topic sentence and several supporting sentences in the following. The basic structure of an essay is quite similar to that of a paragraph—an introductory part always includes the thesis statement of an essay, implicitly or explicitly. And there are some main requirements to complete an essay—rephrase the key points in the body of an essay, restate the theme in different words, give a conclusion or some suggestion, call for some action, etc.

The Solutions to the Students’ Problems

In order to help my students learn English efficiently and effectively, some relevant measures have been taken.

Firstly, the students were reminded that there were typical rhetorical differences between English and Chinese. This information will help them know that rhetoric is culturally diverse.

Secondly, the students were asked to read and compare two groups of texts which were written in English and Chinese in order to let them recognize the differences in structure of an essay between English and Chinese.

There are several reasons why the essays were selected as the teaching materials. The first reason is that each group has the same topic which will be helpful for the students to compare and contrast them. The topic of the essays in one group is about “death” while that in the other group is on “study”. The two English essays, *Of Death* and *Of Studies*, were written by Francis Bacon (Bacon, F., 1998). One of the Chinese essays is *On Death* (论死亡) written by ZHOU Guoping (周国平), a modern Chinese philosopher and writer, and the other one is *Encouraging Learning* (劝学篇) written by Xunzi (荀子), a famous Confucian thinker and educator in the Warring States Period of China.

Another reason to select them is that most students are familiar with three of the four essays. Many students read the English essays in Chinese version in high schools. Therefore, it’s not difficult for the students to understand them in English although the forms of some words are different from these used today, such as passeth—passes, aspireth—aspires. Meanwhile, all Chinese high school students learned *Encouraging Learning*. Familiar with the contents, the students could ignore the difficult words in them and focus on the structures and rhetorical skills of them easily.

The third reason to choose them is that the structures of the two English essays are relatively typical in English. Readers can grasp the main ideas of them as soon as they begin to read. Both of the Chinese essays are typical in rhetoric of Chinese. ZHOU Guoping states his central idea in the concluding paragraph, and Xunzi used a lot of analogies.

Take the following examples. In the first part of *Of Death*, at the beginning, Bacon said, “Men fear death, as children fear to go in the dark; and as that natural fear in children is

increased with tales, so is the other”, and then he argued that people feared to die just because of their own imagination. Finally, ending the paragraph with the words—“Groans, and convulsions, and a discolored face, and friends weeping, and blacks, and obsequies, and the like, show death terrible”, Bacon restated that the things related to death make it more terrible. In the developing part, Bacon stated, “It is worthy the observing, that there is no passion in the mind of man so weak, but it mates, and masters, the fear of death; and therefore, death is no such terrible enemy, when a man hath so many attendants about him that can win the combat of him.” Then, he gave a lot of examples to support his argument. In conclusion, Bacon said that it was the great preparation for death made it more fearful, and to die was as natural as to be born. Bacon ended his exposition with the words—“it (death) openeth the gate to good fame, and extinguisheth envy”—to affirm that death is not terrible. From the very beginning to the end, readers are clear that the author tried to argue that death was not terrible.

Similarly, in *Of Studies*, Bacon made his central idea clearly at the beginning with the words—“Studies serve for delight, for ornament, and for ability”, and then stressed the importance of study with the words—“the general counsels, and the plots, and marshalling of affairs, come best from those that are learned”. In the second part, Bacon argued that “reading maketh a full man”, and said different kinds of books could develop different abilities of a person. Finally, he concluded that “every defect of the mind may have a special receipt.”—every defect in mind may be repaired by reading (study).

However, the two Chinese essays are quite different in expressions and organizations. In *On Dearth*, ZHOU Guoping starts his argument with the scene of Tomb-sweeping Day, a festival for Chinese people to mourn for their nearest dead relatives. Then he says, “Although I often meditate on the problem of death, I never think that it is necessary to think about how to make preparation for my old age and how to live in old age (尽管我时常沉思死的问题, 但我从不觉得需要想一想防老养老的事情).” In the following, he mentions the different attitudes toward death between Western and Chinese philosophers, and he explains why death is but also isn’t worthy of sympathy. After that, he talks about how he would spend his life. Only when reading the last sentence of this essay, readers suddenly realize the author laments the present ignored by common people who try their best to prepare for future—“ordinary people always devote themselves to the undependable tomorrow and tomorrow next by sacrificing today and another today as a means (世人往往为不可靠的明天复明天付出全部心力, 却把一个个今天都当作手段牺牲掉了).” In fact, Zhou really wants to persuade his readers into valuing the present which is what everyone can have control of and make use of.

In most parts of the essay, *Encouraging Study*, Xunzi always gave a lot of analogies at first, and then stated the main idea explicitly. By this pattern—analogies + a main idea, Xunzi convincingly argued for the importance of study, learning methods, and so on.

Xunzi started with the words—“A sage said that study must never cease (君子曰: 学不可以已)”. However, next, he said, “Indigo is extracted from blue but it is darker than blue. Ice is made of water but it is colder than water (青, 取之于蓝, 而青于蓝; 冰, 水为之, 而寒于水).” It seems that these two sentences are not related to the theme—study. However, Chinese readers know they will find out the author’s meaning then. In the following, the author implied the significance of study with another three more analogies. After the five analogies, Xunzi illustrated that study could change a person and make him behave prudently by saying

“Wise men study widely, examine and reflect themselves every day. Thereby, they are wise and behave well (君子博学而日参省乎己，则知明而行无过矣).”

When talking about the importance of knowledge accumulation, arguing the necessity of persistence in study as well as the importance of concentration, he used metaphors, too. For example, by saying “Accumulated soil can make a mountain where rain will fall and wind will blow; Collected water can form a deep pond where there will be a dragon (积土成山，风雨兴焉；积水成渊，蛟龙生焉)”, he summarized that a person would have virtue by continuously doing good, and could have great mind naturally then. Thus, they would have wisdom (积善成德，而神明自得，圣心备焉).

Without explicative arguments but the analogies, Xunzi guided his readers to sum up the similar or same points as his in study.

To the readers who are not familiar with Chinese rhetorical devices, they, perhaps, feel a little puzzled when reading these essays. It seems that Zhou’s argument is kind of out of focus because he doesn’t state his central ideal till the end of his essay while what Xunzi wrote is not related to study sometimes. However, Chinese readers have no problem to understand what they wanted to argue and can enjoy the pleasure in reading them.

By contrasting these two groups of essays, the students would be conscious of the rhetorical dissimilarities in the two languages. Perhaps, it would be easier for them to read between the lines when reading in English and to organize their English compositions properly.

Thirdly, the students were asked to recall how their high school teachers instructed them to compose in Chinese. They have to recall their teachers’ requirements and to reflect why their teachers asked them to do so. They should share their experience and reflection in class and find out the relationship between their teachers’ requirements and Chinese rhetoric. Only two of 130 freshmen in the class of 2014 said their teachers introduced a pattern for them to imitate when guiding them to write an exposition. That was, the thesis statement would be presented in the introduction of a composition while the central idea of the essay should be stated in the concluding paragraph, which is quite similar to the structure of an English essay. However, other students never mentioned any compositional structure. Through these activities, they had a clear idea that there was no some unvaried basic form for them to follow in Chinese.

Fourthly, the basic, typical structure of an English essay was explicitly emphasized, which will help them recognize the differences in organization between the two languages, and organize their ideas properly in English composition. Meanwhile, this introduction will be definitely helpful for them to comprehend English texts.

Fifthly, within following several periods, they were required to skim through some essays from their English textbooks and tried to find out the thesis statement and traced the outline of each essay. Then, in classroom, the students discussed what they had found together. Thus, they could have a clear idea about the main point and the structure of each essay. Many students said that they daren’t believe it’s the thesis statement when they found it in the introductory paragraph(s) because it was so obvious. They said they had thought it would be difficult to find the central idea of an essay. Obviously, they were influenced by Chinese rhetoric.

Conclusion

These methods have been practiced within three batches of freshmen since 2010 and proved that they are helpful. Of course, some minor adjustments were made to these teaching methods in these years. For example, in the first try, only two essays were chosen for students to read and contrast. After several weeks' practicing, the students could not only reinforce the knowledge about the basic structure of English essays but also gradually build the structure in their minds. Gradually, most of the freshmen became more confident when reading an English essay, and could find the thesis statement and know the structure of each English text from their textbooks within a few minutes before reading them intensively. With the help of the outline of a text, they found it easier to comprehend the essay better. Many of them came to organize their English compositions properly. Within the last two years, some of my colleagues attended my classes, and they said my methods could work.

References

- Bacon, F. (1998). *Of Death & Of studies. Essays*. Beijing: Foreign Language Teaching and Research Press: 7, 138.
- Buscemi, S. V. (1990). *A Reader for Developing Writers*. Middlesex County College: McGraw-Hill, Inc.: 52, 76, 82.
- Emory, D. (1995). *Improve Your Essays*. Westerville: Glencoe/McGraw-Hill: 9, 15-16, 22.
- Herzfeld-Pipkin, N. (2007). *Writing for Academic Success*, Beijing: China Renmin University Press Co. LTD: 15, 54, 91.
- Kaplan, R. B. (2001). Cultural Thought Patterns in Inter-cultural Education. *Landmark Essays on ESL Writing*. T. Silva and P. K. Matsuda. Mahwah, NJ, Lawrence Erlbaum Associates: 11-25
- Kay, S. (2011). Speech writing checklist. *21st Century*, 2001, Oct. 11th (15): paragraph. 8, 9, & 10.
- Mai, J. (2014). *Gaokao Zuowen Moban (The Patterns of Compositions for National University Entrance Examination)*. Beijing: Guangming Daily Press: 12.
- Scollon, R., Scollon, S. W. & Kirkpatrick. A. (2000). *Contrastive Discourse in Chinese and English—A Critical Appraisal*. Beijing: Foreign Language Teaching and Research Press: 164.
- Scollon, R., Scollon, S. W., & Kirkpatrick. A. (2000). *Contrastive Discourse in Chinese and English—A Critical Appraisal*. Beijing: Foreign Language Teaching and Research Press.
- Wang, W. Y. (2013). *Huojiang Zuowen (Prize Compositions)*. Beijing: Blossom Press.
- Zhou, G. P., *Lun Siwang (On Dearth)*. (2011, 04, 04).
http://blog.sina.com.cn/s/blog_471d6f6801017ucl.html.

INTERNATIONAL CONFERENCE ON LANGUAGE LEARNING AND TEACHING 2015

November 13 - 15, 2015

Higher Colleges of Technology - Dubai Men's College
Academic City, Dubai, UAE

Language Learning and Teaching Opportunities in the 21st Century

Organized by the 21st Century Academic Forum and the Higher Colleges of Technology



CONFERENCE PROCEEDING VOL. 8, NO. 1 ISSN: 2330-1236